



AGRICULTURAL RESEARCH INSTITUTE

PUSA

VOL. XV, PART I

January 1920

THE AGRICULTURAL JOURNAL OF INDIA

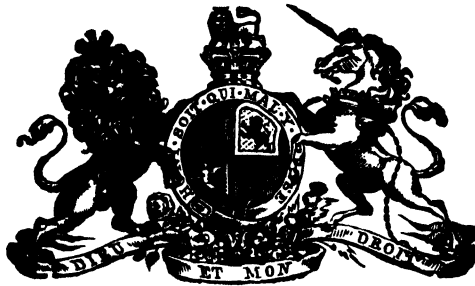

EDITED BY

The Agricultural Adviser to the Government of India

PUBLISHED FOR

THE IMPERIAL DEPARTMENT OF AGRICULTURE IN INDIA

BY

THACKER, SPINK & CO., CALCUTTA

W. THACKER & CO., 2, CREED LANE, LONDON

Price R. 1-8 or Two Shillings

	PAGE
SANN-HEMP. Growth of—in black soil	646
SAYER, WYNNE. Natalite	682
SCION. Influence of stock and-	533
<i>Scirpus kysoor</i> AS FAMINE FOOD	41
SEED ELECTRIFICATION	221, 570
SEED-RATE OF SUGARCANE	686
SEED STORAGE BINS	8
SELECTION. Improvement of exotic crops by—	57
<i>Sesbania aculeata</i> . Growth of—in <i>bhata</i> soil	646
SEWAGE SLUDGE AS MANURE	69
SHAW, F. J. F. Eleventh Meeting of the Board of Agriculture in India	135
SHEEPFOLD MANURE. Biochemical decomposition of—in soil	398
SHRIVASTAVA, K. P. Improvement of oranges	508
SOIL. Ammonification of manure in—	584
SOIL, <i>bhata</i> . Chemical and biological aspect of-	644
SOILS, EMBANKED. Wheat cultivation on--	289
„ INDIAN. Exhaustion of—and the methods by which this may be remedied. R. V. Norris	433
SOUTHERN-WOODHOUSE MEMORIAL FUND	108, 353
STOCK. Influence of—and scion. S. H. Prayag	533
STOCK-FEEDING VALUE OF SUGARCANE MOLASSES	571
SUGAR. British Empire—Research Association	219
„ Indian—Committee	87
„ Palmyra palm as a source of---	32
„ The 1919 Tucuman—crop. W. E. Cross	659
„ World's—supplies	201, 683
SUGAR FROM THE DOUGLAS FIR	467
„ INDUSTRY, ARGENTINE. Work of Tucuman Station for--	191, 659
SUGAR RAW. Improved furnaces for manufacture of---.. ..	521
„ „ Manufacture of—from juice of date palm	525
SUGARCANE. Botanical improvement of-	207
„ Growth of- 185, 334, 425, 543, 650	
„ Java—varieties in Argentine	191, 659
„ Origin of the—	564
„ Packing seed—for transport	174
„ Seed rate of—	686
SUGARCANE CULTIVATION. Development of—around Nellikuppam	154
„ „ Improved methods of—. G. Clarke, Naib Hussain and S. C. Banerjee. (Review)..	474

	PAGE
SUGARCANE FIJI B. Cultivation of—in South India	157
„ MOLASSES. Stock-feeding value of—	571
SUGARCANES. Habit in—U. Vittal Rao	418
SUGARCANES, RATOON. Use of trash in cultivation of—	685

T

TABANIDÆ	361
“TAMBERA” DISEASE OF POTATO. Harold H. Mann, and S. D. Nagpurkar	282
TAMHANE, V. A. Comparison of salt lands in the Deccan and in Sind ..	410
THADANI, K. I. Some notes of cotton in Sind	393
THOMPSTONE, E. Ginning percentage of cotton in relation to season..	568
TILLAGE IMPLEMENTS. Manufacture of improved—in India ..	138
“TOP WORKING” OF INDIAN FRUIT TREES. W. Burns and P. G. Joshi..	516
TOXINS. Excretion of—from roots of plants. J. N. Mukerjea ..	502
TRACTOR	138, 144, 341, 348, 455, 691
TREES. Treatment of wounds on—	690
<i>Trifolium alexandrinum</i> in the CENTRAL PROVINCES	382
TUCUMAN SUGAR EXPERIMENT STATION. Work of— ..	191, 659
<i>Typha angustata</i> as famine food	41

U

URINE. Biochemical decomposition of—in soil	398
---	-----

V

VARIETY TRIALS. Avoiding of cross-fertilization in—	5
VEGETABLES. Canning of—	76
VENKATRAMAN, T. S. A few hints on labelling in experimental stations	45
„ Packing seed sugarcane for transport	174

W

WAGTAIL, THE WHITE	592
WATER HYACINTH : A MENACE TO NAVIGATION. E. Johnson ..	550
„ POWER RESOURCES IN INDIA. Preliminary report on— J. W. Meares. (Review)	115
WATER SAVING TRIALS IN GWALIOR	160
WATERING OF GRAM PLANT. Effect of—on secretion of acids ..	636

	PAGE
WHEAT. Botanical improvement of—	208
• „ Production and distribution of—in the world	313
„ Production and trade of—in India	327
„ Varieties and qualities of—	311
WHEAT CULTIVATION ON EMBANKED SOILS	289
„ PRODUCTION. Future of—with special reference to the Empire	301
WITTLE, A. H. Possibilities of <i>Citrus</i> culture in India	444
WOODHOUSE-SOUTHERN MEMORIAL FUND	108, 353
WOODPECKER. The golden-backed—	481

Agents for the Sale of Government Publications

IN EUROPE

- Constable & Co., 10, Orange Street, Leicester Square, London, W.C.
Kegan Paul, Trench Trübner & Co., 68-74, Carter Lane, E.C., and 25, Museum Street, London, W.C.
Bernard Quaritch, 11, Grafton Street, New Bond Street, London, W.
P. S. King & Sons, 2 & 4, Great Smith Street, Westminster, London, S.W.
H. S. King & Co., 65, Cornhill, E.C., and 9, Pall Mall, London, W.
Grindlay & Co., 54, Parliament Street, London, S.W.
Luzac & Co., 46, Great Russell Street, London, W.C.
W. Thacker & Co., 2, Creed Lane, London, E.C.
T. Fisher Unwin, Limited, 1, Adelphi Terrace, London, W.C.
B. H. Blackwell, 50 & 51, Broad Street, Oxford.
Deighton, Bell & Co., Ltd., Cambridge.
Oliver & Boyd, Tweeddale Court, Edinburgh.
E. Ponsonby, Ltd, 116, Grafton Street, Dublin.
Ernest Leroux, 28, Rue Bonaparte, Paris.
Martinus Nijhoff, The Hague, Holland.

IN INDIA AND CEYLON

- Thacker, Spink & Co., Calcutta and Simla.
W. Newman & Co., Calcutta.
R. Cambray & Co., Calcutta.
S. K. Lahiri & Co., Calcutta.
B. Bannerjee & Co., Calcutta.
The Indian School Supply Depot, 309, Bow Bazar Street, Calcutta, and 226, Nawabpur, Dacca.
Butterworth & Co. (India), Ltd., Calcutta.
Rai M. C. Sarkar Bahadur & Sons, 75-1-1, Harrison Road, Calcutta.
The Weldon Library, 18-5, Chowringhee Road, Calcutta.
Standard Literature Co., Ltd., Calcutta.
Lal Chand & Sons, Calcutta.
Higginbothams, Ltd., Madras.
V. Kaliyanarama Iyer & Co., Madras.
G. A. Natesan & Co., Madras.
S. Murthy & Co., Madras.
Thompson & Co., Madras.
Temple & Co., Madras.
P. R. Rama Iyer & Co., Madras.
E. M. Gopalakrishna Kone, Madura.
Thacker & Co., Ltd., Bombay.
A. J. Combridge & Co., Bombay.
D. B. Taraporevala, Sons & Co., Bombay.
Mrs. Radhabai Atmaram Sagoon, Bombay.
Sunder Pandurang, Bombay.
Gopal Narayan & Co., Bombay.
Ramchandra Govind & Son, Kalbadevi, Bombay.
A. H. Wheeler & Co., Allahabad, Calcutta, and Bombay.
N. B. Mathur, Superintendent, Nazir Kanun-i-Hind Press, Allahabad.
Rai Sahib M. Gulab Singh & Sons, Mufid-i-Am Press, Lahore.
A. Chand & Co., Lahore, Punjab.
Ram Krishna & Sons, Lahore.
Superintendent, American Baptist Mission Press, Rangoon.
Manager, the "Hitavada," Nagpur.
S. C. Talukdar, Proprietor, Students & Co., Cooch Behar.
A. M. & J. Ferguson, Colombo, Ceylon.
Manager, Educational Book Depôts, Nagpur and Jubbulpore.*
Manager of the Imperial Book Depot, 63, Chandney Chauk Street, Delhi.*
Manager, "The Agra Medical Hall and Co-operative Association, Ltd." (Successors to A. John & Co., Agra.)*
Superintendent, Basel Mission Book and Tract Depository, Mangalore.*
P. Varadachary & Co., Madras.*
H. Liddell, Printer, etc., 7, South Road, Allahabad.*
D. C. Anand & Sons, Peshawar.*
Ram Dayal Agarwala, 184, Katra, Allahabad.*
Manager, Newal Kishore Press, Lucknow.*

* Agents for the sale of Legislative Department Publications only.

CONTENTS

(VOL. XV, PART I.)

ORIGINAL ARTICLES

	PAGE
SOME COMMON INDIAN BIRDS. NO. 1—THE INDIAN ROLLER (<i>Coracias indica</i>)	<i>T. Bainbrigg Fletcher, R.N., F.L.S., F.E.S., F.Z.S.; and C. M. Inglis, M.B.O.U.</i> 1
SOME LABOUR-SAVING DEVICES IN PLANT- BREEDING	<i>A. Howard, C.I.E.; and G. L. C. Howard, M.A.</i> .. 5
DR. C. A. BARBER, C.I.E., SC.D. (Cantab.), F.L.S.	<i>J. Mackenna, C.I.E., I.C.S.</i> .. 11
CO-OPERATIVE LAND MORTGAGE CREDIT FOR INDIA	<i>H. R. Crosthwaite, C.I.E.</i> .. 16
A NEGLECTED SOURCE OF SUGAR IN BIHAR	<i>M. N. Ghosh, M.A.</i> 32
SOME FAMINE FOODS IN AHMEDABAD	<i>G. P. Pathak, B.Ag.</i> 40
A FEW HINTS FOR LABELLING IN EXPERIMENTAL STATIONS	<i>T. S. Venkataraman, B.A.</i> .. 45
THE IMPROVEMENT OF FRUIT PACKING IN INDIA	<i>A. Howard, C.I.E., M.A.; and G. L. C. Howard, M.A.</i> .. 51

SELECTED ARTICLES

PLANT-BREEDING AND TROPICAL CROPS	55
THE WORK OF THE ROTHAMSTED EXPERIMENTAL STATION FROM 1914 TO 1919	63
THE CANNING OF FRUIT AND VEGETABLES .. .	76

NOTES

	PAGE
A SUSPECTED CASE OF POISONING FROM LINSEED CAKE	85
INDIAN SUGAR COMMITTEE	87
COLLOIDS AND CHEMICAL INDUSTRY	91
REMOVAL OF RESIDUAL FIBRES FROM COTTON-SEED AND THEIR USES ..	93
MANIPULATION OF SHORT-FIBRED COTTON	95
AGRICULTURAL EDUCATION IN CENTRAL PROVINCES	97
FEDERAL FARM LOAN ACT OF THE UNITED STATES	100
POSITION OF SEED IN COTTON	103
AGRICULTURAL PESTS AND DISEASES ACT IN COIMBATORE DISTRICT ..	105
WORLD'S FOOD CROP	107

**PERSONAL NOTES, APPOINTMENTS AND TRANSFERS,
MEETINGS AND CONFERENCES, ETC. 108**

REVIEWS

A MANUAL FOR CO-OPERATIVE SOCIETIES IN THE BOMBAY PRESIDENCY	112
JOURNAL OF INDIAN BOTANY	114
FIRST REPORT OF THE BOMBAY CENTRAL CO-OPERATIVE INSTITUTE ..	115
THE PRELIMINARY REPORT ON THE WATER POWER RESOURCES IN INDIA	115
NEW BOOKS ON AGRICULTURE AND ALLIED SUBJECTS ..	118

LIST OF ILLUSTRATIONS

The Indian Roller (<i>Coracias indica</i>)	Frontispiece
	Facing page
Plate I. Muslin covers with inseed	6
„ II. Dr. C. A. Barber	11
„ III. Fig. 1, Toddy-collector squeezing male fingers of palmyra palm	
Fig. 2. Toddy-collector climbing palmyra palm ..	33
„ IV. Labels used at the Cane Breeding Station, Coimbatore	46
„ V. Ditto	48
„ VI. Ditto	49
„ VII. Equipment for canning fruit and vegetables ..	78

*The following Original Articles will appear in our next issue
(March 1920).*

- SOME COMMON INDIAN BIRDS. No. 2—THE
BLUE-TAILED BEE-EATER (*Merops philippinus*). *T. Bainbrigge Fletcher, R.N.,
F.L.S., F.E.S., F.Z.S.;
and C. M. Inglis,
M.B.O.U.*
- THE MOTOR TRACTOR IN AGRICULTURE: SOME
IMPRESSIONS OF THE TRACTOR TRIALS HELD AT
LINCOLN IN SEPTEMBER 1919 *T. F. Maine, B.Sc.*
- NOTES ON THE PROGRESS OF THE EUROPEAN
OLIVE AT PESHAWAR *W. Robertson Brown*
- THE DEVELOPMENT OF CANE PLANTING BY
THE EAST INDIA DISTILLERIES AND SUGAR
FACTORIES, LTD.
- THE DRYING OF BANANAS *W. Burns, D.Sc.; and P. G.
Joshi*
- PACKING SEED SUGARCANES FOR TRANSPORT .. *T. S. Venkataraman, B.A.*
- SWARMING CATERPILLARS OF NORTHERN GUJARAT *T. N. Jhaveri, B.Ag.*



THE INDIAN ROLLER (*CORACIAS INDICA*).

Original Articles

SOME COMMON INDIAN BIRDS.

No. 1. THE INDIAN ROLLER (*CORACIAS INDICA*).

BY

T. BAINBRIGGE FLETCHER, R.N., F.L.S., F.E.S., F.Z.S.,
Imperial Entomologist,

AND

C. M. INGLIS, M.B.O.U.

[THE importance of many common birds to agriculture in India is admittedly very great. Some birds are wholly or partially graminivorous and do a great deal of damage to crops, whilst others feed wholly or partly on insects and are in most cases beneficial by helping to reduce damage caused by insect pests. Many years ago I suggested that the recognition of the more important birds, from the agricultural view-point, might be helped by the issue of a series of coloured plates of such birds, but the difficulty has been to get such plates drawn, as work of this sort requires an artist who is also an ornithologist; otherwise, the work produced is unnatural. We have therefore been fortunate in securing the services of Mr. C. M. Inglis to provide coloured illustrations of about two dozen of our commoner birds. The present paper will, it is hoped, be followed at regular intervals by others in the same series.—T. B. F.]

THE Indian Roller or Blue Jay (*Coracias indica*) is one of the birds of the Plains which must have brought itself to the notice of

all if merely on account of its vivid colouring, which has been aptly described as a study in Oxford and Cambridge blue. Although commonly called a jay, this bird is more nearly allied to the bee-eaters and kingfishers, its relationship to the latter group being evidenced, as recorded by Gordon Dalglish, by the fact that it has been seen to plunge into the water like a kingfisher, this most unusual occurrence indicating an affinity to the kingfisher in habits, especially to the white-breasted species which is practically an insect-feeder. As a matter of fact, *C. indica* belongs to the group of rollers, so called because of the extraordinary aerial gymnastics indulged in by these birds, as may be seen especially during the early part of the hot weather, when courtship takes place.

The Indian Roller occurs throughout the Plains of India and Ceylon, neither ascending the Hills nor occurring in areas of desert or thick jungle. Calcutta seems to be about its eastern limit of occurrence and East of that it is replaced by the Burmese species, *Coracias affinis*, which is slightly larger and much darker, with a lighter tail which lacks the purple band at the tip which sets off so well the tail of the Indian Roller. In the Duars both species have been got and where they meet they hybridize freely. In Northern India a third species of Roller, *Coracias garrula*, which is a migrant from Africa and Europe, also occurs and may be distinguished by its lower parts being pale blue throughout, whereas in the Indian and Burmese Rollers, the lower parts are only blue in part. There is also a forest species, *Eurystomus orientalis*, the Broad-billed Roller, with a red bill and legs; this is a rather silent bird and exceedingly wary and frequently nests in non-accessible holes in large *Simul* (*Bombax malabaricum*) trees.

Where it does occur, the Indian Roller is usually found commonly and is not a bird which can be overlooked when on the wing, as its brilliant blue colours are then displayed to advantage. When at rest upon a branch or telegraph wire, however, this bird is by no means conspicuous, as the wings are then closed and the colours are not very evident. Its usual habit is to sit on any convenient perch and watch patiently until some desirable prey comes into sight, when it flies down, secures its quarry, which is always

swallowed whole, and returns to its perch. Ordinarily it appears to be a decidedly sluggish bird, sitting for hours on the same perch, occasionally jerking its tail and emitting a sharp harsh "Tjock." At the breeding season, which occurs in Bihar from March to the end of June, and as early as January in Ceylon, these birds, however, become more active and vociferous, their harsh, staccato gutturals being evidently pleasing to the opposite sex. It is at this time also that they indulge in the weird evolutions which have earned these birds the title of Rollers. As both sexes wear the same livery it is difficult to tell which is which, but two birds may often be seen sitting side by side on some exposed perch at this season of the year and uttering a sort of chuckling sound. One of them, presumably the cock bird, then flies off and up into the air to a considerable height whence he descends in a regular "nose-glide," displaying his vivid colours and uttering short harsh screams all the while, ultimately returning to perch beside his mate.

The nest is placed in a hole in a tree or building and is generally lined with a varying amount of vegetable fibre, grass, a few feathers or some old rags, but the lining is often omitted altogether. Four, or sometimes five, glossy-white eggs are laid. The young are quite naked at first, but, later on, when the feathers have grown, are marked with vivid blue like their parents. Mr. Aitken considered the parent birds very wary and the nests difficult to discover, but in Bihar at any rate this is not the case, it being one of the easiest nests to find, the birds continually chasing away any intruders that come near the nesting site.

Besides being an ornament to any landscape, the Indian Roller is an extremely useful bird, as its food consists almost entirely of large insects, such as grasshoppers, crickets and beetles, varied by an occasional small mouse, frog or snake. One kept by Mr. Finn even digested a toad, which must have been a very "tasty" morsel. The late C. W. Mason examined the stomachs of eighteen birds between January and October at Pusa and found¹ that of 412 insects taken by these birds, only 4 were beneficial, 111 were

¹ *Mem. Dept. Agric. India, Entl. Ser.*, vol. III, pp. 155-159.

injurious and 297 neutral. Of the injurious insects taken 52 were grasshoppers, 18 crickets and 23 caterpillars, mostly cutworms, so that the good done by the destruction of these injurious insects far more than counterbalances the fact that a very few beneficial insects were taken.

It is therefore unfortunate that the Roller's brilliant plumage should frequently lead to its being shot by Europeans, especially in the neighbourhood of military cantonments, for the sake of its wings. According to the late C. W. Mason, "being one of our common species of birds, and the gaudy colour very striking to any one new to the Country, numbers of these birds are shot by Europeans in order to send one or two wings home, and they are sent home not declared, or falsely declared. From what I have seen, I do not imagine that more than one out of six pairs of wings ever sees the destination for which they were originally obtained. Some specimens are not good enough, while others are put away, forgotten, and eventually thrown away." It should therefore be noted that the Indian Roller is protected, under the Wild Birds and Animals Protection Act, throughout the whole year in Bihar and Orissa and in Delhi. In view of its beneficial activities to the Indian *rakyat*, it is to be hoped that the numbers of this bird will not be allowed to diminish throughout the area of its occurrence.

This bird is sacred to Siva and it is said they are liberated during the Durga Pujah.

Falconers fly the Red-headed Merlin (*Æsalon chicquera*) at this bird. Jerdon says "it is often baulked by the extraordinary evolutions of the Roller who now darts off obliquely, then tumbles down perpendicularly, screaming all the time, and endeavouring to gain the shelter of the nearest tree or grove."

SOME LABOUR-SAVING DEVICES IN PLANT-BREEDING.

BY

ALBERT HOWARD, C.I.E.,
Imperial Economic Botanist ;

AND

G. L. C. HOWARD, M.A.,
Second Imperial Economic Botanist.

THE investigator concerned with the improvement of crops is constantly liable to the danger of being overwhelmed by detail. Cultures multiply rapidly, the number of samples of seed involved soon runs into thousands and it is necessary to record every year a considerable amount of detail. To be of any value the work must be accurate and the experimental error must be reduced to the lowest limit. As long as the crops are in the ground, if the danger of cross-fertilization is avoided, no particular harm can occur. The moment, however, a culture is harvested many things are possible. Between reaping and sowing, any plant or any series of plants have to be handled a good many times, the seed has to be examined and afterwards stored till planting time comes round again. If the investigator aims at the personal supervision of all essential details, it is obvious that he must utilize every possible device which saves time and fatigue and which also prevents mistakes. The present paper deals with some of the methods employed in the Botanical Area at Pusa in dealing with the numerous cultures involved in the plant-breeding work. As correspondents and visitors have frequently asked for information on these matters, it is considered that a brief account of some of the labour-saving devices in use may prove to be of general interest.

THE PREVENTION OF CROSSING.

A combination of high temperature and high humidity reduces very considerably the value of the perforated parchment bag in

India for the exclusion of foreign pollen. The amount of seed set under these conditions is often small, the bags have to be moved constantly to allow for growth, while accidents due to wind and rain are frequent. Far better results are obtained with infinitely less labour and risk by the use of the cylindrical muslin cover illustrated in Plate I. They are made of three bamboo rings which are covered by the ordinary muslin of the bazaar. For most purposes the total length need not exceed 30 inches and a diameter of 13 inches is convenient. These completely enclose small plants like linseed or gram. For taller plants like tobacco, the inflorescence only need be covered. In cases of very tall plants like jute (*Corchorus capsularis*, L.) or *patwa* (*Hibiscus cannabinus*, L.), which bear flowers on a large portion of the stem, much longer covers are desirable which allow for growth and which are best attached soon after flowering begins. These muslin covers are easily washed after use, they last for two seasons and are easily stored. No cases of cross-fertilization have been detected through their use.

THE HANDLING OF SINGLE PLANTS.

Both in investigations on the inheritance of characters and in selection work, the seed of numerous single plants has to be harvested and rigidly kept separate. Frequently, when the seed is saved, it is still too moist for examination and storage and one of the difficulties is to dry and keep separate these large collections of damp seed while at the same time preventing any admixture or loss.

Drying boxes, 5' by 3' and 5" deep, the frames of which are made of $\frac{7}{8}$ " sal wood with wire netting ($\frac{1}{2}$ " mesh) above and below, are used for each set of cultures. These boxes are provided with hinged lids and snap locks, two pieces of $\frac{1}{4}$ " bar iron support the wire netting sides and thin galvanized wires are stretched across the frames inside the box to prevent the bags slipping about while the seed is drying. When the seed of any particular set of single plants has to be saved, the bags are placed at once in one or more of these drying boxes, the box is labelled and the lock closed. The locked boxes are placed out in the sun every day till an opportunity occurs for the examination and storage of their contents. By this

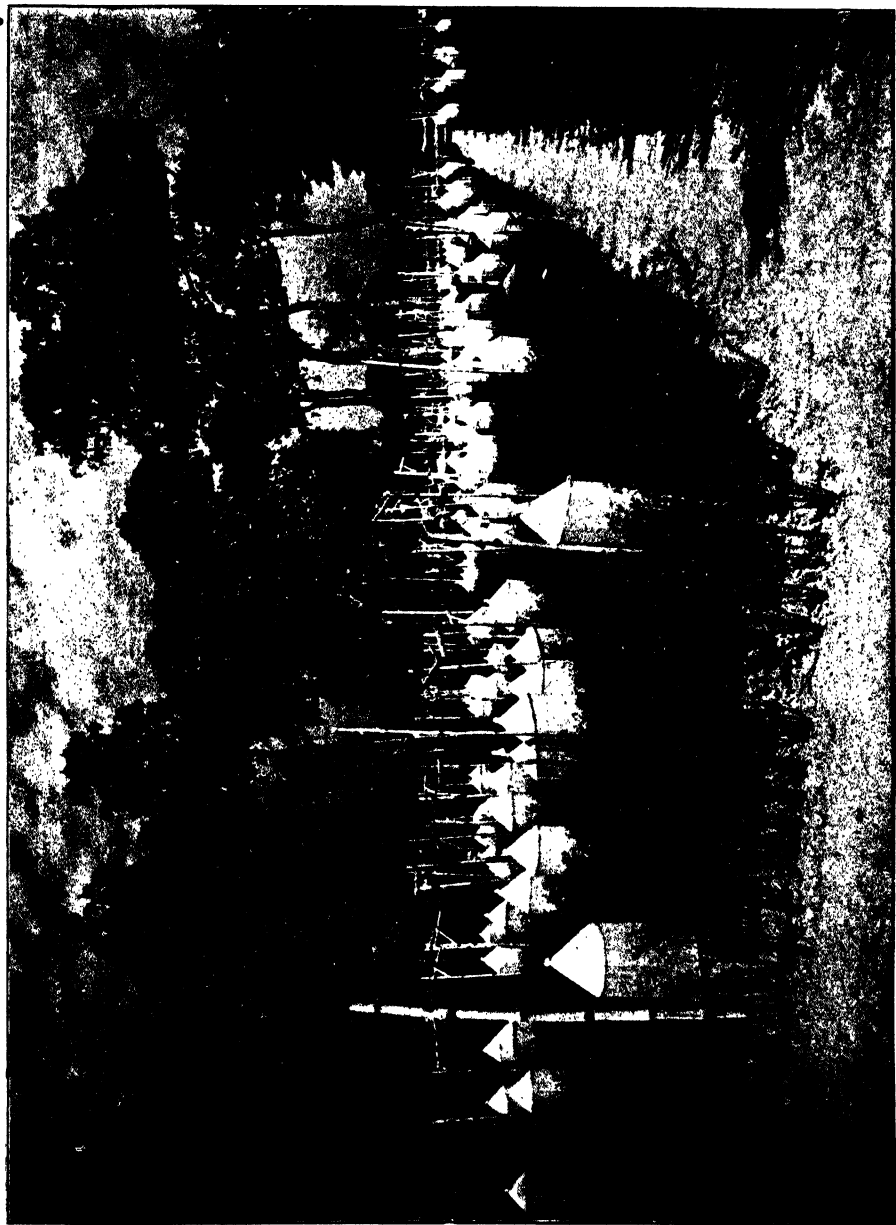

MUSLIN COVERS WITH LINSEED

means, personal supervision is only necessary at the collection, examination and storage of the samples. The rest is routine under conditions where no mistakes are possible. No time is lost in sorting the samples which would occur if several sets of loose seed bags were dried together.

After threshing, the seed of single plants has to be stored and it is often desirable to keep them together in sets. The seed envelopes of strong tough grey paper, known as the Girdwood post-sample bag,* have proved exceedingly useful for this purpose and they last for many years. They are 5" by 2½" in size and are closed by a push-in flap which is very effective and which will stand frequent handling. No separate labels are needed as the culture numbers are written on the outside of the envelope. For examining the seed of single plants and for transferring it to and from these envelopes the flat triangular grain scoops used by corn merchants save much time. Besides their use for storage, these seed envelopes are very convenient in other ways such as the despatch of small samples of seed to and from correspondents. It is not unusual in India to send small samples of seed sewn up in pieces of cotton cloth or to despatch several kinds in ordinary thin letter envelopes enclosed in an outer envelope. In the first case, they frequently arrive with the labels torn and the place of origin lost. In the second case, the thin paper generally bursts in the post and the samples arrive all mixed together in the outer envelope. It saves a great deal of time and trouble to all concerned if empty seed envelopes are enclosed when writing for seed.

VARIETY TRIALS.

The difficulties to be overcome in the trial of varieties and in the interpretation of the results are well known. Such difficulties are by no means confined to the arrangement of the field plots but are encountered at other stages of the work. As in the case of single plants, it is equally essential in dealing with large cultures to ensure that no accidents or mistakes occur between reaping and

* These seed envelopes are manufactured by Messrs. Blake & Mackenzie, Ltd., Islington Liverpool, England.

threshing and between threshing and storage. After reaping, it is often necessary for the crop to dry for a day or two before threshing can be carried out and further drying is necessary before the grain is stored. Admixture and theft are almost bound to occur at all stages unless special precautions are taken.

In conducting variety trials in the Botanical Area at Pusa, a large wire netting drying house, provided with a slightly raised brick floor, has been in use for some years and has been found of great assistance. The plots are reaped and immediately transferred to the drying house where the produce is allowed to dry under lock and key till threshed. This building is provided with sufficient floor space for two large plots with a vacant place between, across which a sheet can be stretched to prevent any admixture. There are large sliding doors at either end so as to admit of the easy entry and removal of produce. The floor of the drying house at Pusa is 50' by 25', the height to the ridge is 18', to the eaves 12'. The sliding doors are 8' by 9'. The wire netting used is $\frac{3}{4}$ " mesh and is supported by angle and bar iron at suitable distances.

The chief point in threshing experimental plots is speed. The whole process, including separation and weighing, should be completed in one shift and nothing should remain lying about at night. This is a powerful argument in favour of reducing the size of the plots as far as is agriculturally expedient. For threshing purposes a small machine driven by a bullock gear is employed. After weighing, the grain is dried for a day on strong sheets in the drying house before storage. If a good labour force is concentrated on threshing and separating, the work is got through very rapidly with the minimum of time and trouble in supervision. Such attention is obviously necessary as there is little purpose in laying out elaborate field experiments of this kind on paper and then leaving such essential matters as the actual determination of the yield to chance. In such work, principles and procedure must closely correspond.

THE STORAGE OF SEED.

The question of seed storage in connection with plant-breeding work is important. It is necessary, not only to keep seed during

the rainy season but also to preserve the germination capacity for several years, so that any particular culture of a series may be repeated whenever required. The method adopted at Pusa is to dry the seed thoroughly in the sun and to put it away immediately in air-tight seed bins. Insecticides like naphthalene and carbon bisulphide have been found to be unnecessary as the pests of stored grain are unable to attack *dry* seeds under these conditions and even if a few of these insects are sealed up with the produce no damage occurs.

The seed bins are, in principle, nothing more than the ordinary earthen *kothis* used by the people but they are made of the thin sheet iron ordinarily purchasable in any bazaar. They were designed for Pusa by Mr. S. A. S. Bunting, formerly Agricultural Engineer in the United Provinces. The essential structural details are shown in the figure below. The bins are cylindrical in shape, 36 inches high

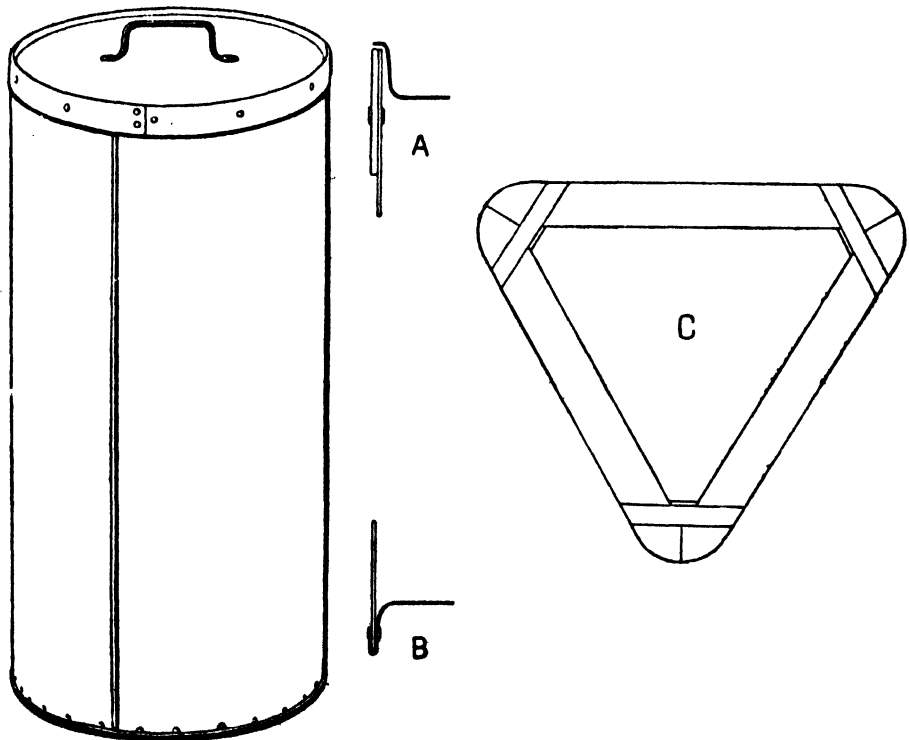

and 18 inches in diameter. The method of constructing the lid is indicated at A and the details of the floor at B. The lid has to be

pressed in firmly after the method often employed in tin canisters. To render the longitudinal seam air-tight, the thin sheet iron is folded. The metal can be preserved from rust by coating inside and out with hot tar in which a suitable proportion of pitch has been dissolved. A number should be painted on the lid and on the cylinder, and as the lids usually fit best in one position this should be indicated by a white line. The numbers not only prevent the lids being mixed but also greatly facilitate the search for any particular sample of seed. To prevent the condensation of moisture on the bottom of the bin and the destruction of the metal by rust, it should stand either on bricks or preferably on a wooden triangle about an inch thick provided with rounded corners. One of the wooden bases is shown in plan at C in the sketch. After the lid has been pressed in, the bin should be hermetically sealed round the upper rim with wax which will not melt during the hot weather and which will not crack during the monsoon. A wax mixture suitable for the temperature at Pusa can be obtained by melting together 4 parts of vaseline with 5 parts of bees-wax and slowly adding 2 parts of powdered rosin. For very high temperatures, the proportion of bees-wax and rosin should be increased. A large number of sample seed bins have been supplied to correspondents in India and many copies have been made. They are now manufactured in sets of 100 by Messrs. Burn & Co., Howrah. For storing seed in bulk for distribution, larger sizes are desirable. Seed stored in this manner retains its germinating power for many years.



CHARLES ALFRED BARBER, C. I. E., Sc. D. (Cantab.), F. L. S.

DR. C. A. BARBER, C.I.E., Sc.D. (Cantab.), F.L.S.

BY

J. MACKENNA, C.I.E., I.C.S.,

Agricultural Adviser to the Government of India.

By the retirement of Dr. Barber, Government Sugarcane Expert, the department loses one of its most popular and most distinguished members.

Charles Alfred Barber was born on the 10th of November, 1860, at Wynberg, South Africa, son of the Revd. William Barber, missionary there. As a boy he was much interested in natural history and soon knew every beast and bird and plant. He came to England in April 1871, and was placed at New Kingswood School at Bath till 1877. Here no science was taught, but he worked at chemistry and geology privately.

He entered the Manchester and Liverpool District Bank, Newcastle-under-Lyme, in 1878; passed through the five years' apprenticeship, qualifying for a head-clerkship or for an accountantship in a small branch. But, during his spare time, Barber had been attending classes in chemistry, and had been privately studying geology and botany. He matriculated in honours and passed the First B.Sc. of London University.

He decided in 1883 to devote his time entirely to science and went to Heidelberg and subsequently entered Bonn University for a year (1883-84). Here he studied chemistry, physics, mineralogy, zoology and botany. In these studies botany soon took first place because of the excellence of the teaching. The full course under Professor Strasburger consisted of 184 lectures and there were special

courses under Scmitz in mycology and Schimper in plant distribution. In chemistry the full course was under Professor Wallach, and for some time he worked in the same laboratory as Mr. J. W. Leather whom he was to meet later in India.

Barber entered Christ's College, Cambridge, in 1884. He was too old for an entrance scholarship, but was placed equal with the senior science scholar in the first examination of the year, and was granted a major foundation scholarship which was continued for seven years. He gave up chemistry because of the poor equipment of the laboratories and took up botany, zoology and human physiology. During his first year at Cambridge, Barber acted as demonstrator in elementary biology and, in the third term, was asked to assist Dr. Scott at University College, London, in preparing students for the elementary and advanced examinations of London University. Owing to the sudden death of Professor Huxley, Dr. Scott succeeded him in the teaching of the botanical section at South Kensington, and Barber was charged with the whole work at very short notice. He continued this teaching for three years while carrying on his studies at Cambridge. He took Part I of the Cambridge Science Tripos in 1888, and Part II in 1889, obtaining a first class in each. Having assisted in teaching elementary biology for several years, Barber was offered work as demonstrator in zoology and also demonstrating work in human physiology by Professor Foster. But he decided to take up botany and became University demonstrator in 1889. Owing to the great expansion in the school then taking place, Barber had a large portion of the lecturing, especially for the second part of the Tripos, and was in chief charge of all the demonstrating in the school. He published six papers in the "Annals of Botany," chiefly on fossil botany, and became examiner in botany in Oxford University and assistant examiner in London University and elsewhere.

Barber left Cambridge in 1891 to take up an appointment as Superintendent of Agriculture in the Leeward Islands. He had charge of gardens in Antigua, Montserrat, Dominica, St. Kitts and Virgin Islands, with, later on, a fibre plantation in Anguilla and a sugar plantation in St. Kitts. Owing to the fall in the price

of sugar, the Islands became bankrupt and the appointment ceased in 1895, ten years' pension being granted by the Colonial Office.

After temporary work at the British Museum, Barber was appointed to succeed Professor Marshall Ward in the teaching of botany at the R. I. E. College at Cooper's Hill. He commenced the study of the internal morphology of timber and published one paper on a fossil Gymnosperm in the "Annals of Botany." He also acted as Professor of Botany at the Royal Holloway College at Egham, and did a good deal of examining.

In 1898 Barber left Cooper's Hill to take up the appointment of Government Botanist, Madras, with the idea of completing the collections of the Madras flora and the preparation of a description of it. He was appointed Director of the Botanical Survey for South India, including Madras, Hyderabad, Mysore, Travancore and Coorg and Cochin. Almost at once, however, the study of diseases in crops was added to his other duties. Commencing with the sugarcane, this was afterwards extended to groundnut and later on to pepper. He founded three farms for the study of these staples, at Samalkota, Palur, and Taliparamba, respectively. In addition to the survey, therefore, a considerable amount of agricultural work was required and to this was gradually added economic botany, entomology and mycology. During this period his spare time was devoted to the study of *Haustoria* of the Sandal, *Cansjera*, *Ola* and *Ximenia* and four Memoirs were published in the Botanical Series of the Agricultural Department of the Government of India. For this and previous research work, the degree of Doctor of Science at Cambridge University was awarded in 1907. In 1908, while on ten months' study leave, he visited all the important agricultural colleges in the United Kingdom and prepared a history of Kew Gardens for the French Government.

Barber returned to India in 1908, and joined the new Agricultural College at Coimbatore, in charge of the botanical, entomological and mycological sections. Of the two latter branches he was relieved by the appointment of an Entomologist and a Mycologist. The stereotyping of a series of lectures on botany and agricultural botany for Madras was the chief work during these years, but he

also commenced the study of Indian cottons and other economic work as time permitted. He was examiner in Madras University for 10 years and a frequent contributor of leaders to the "Madras Mail."

In 1912 Barber was appointed Sugarcane Expert for the whole of India, but was posted under the Madras Government, and opened the Cane-breeding Station at Coimbatore. This appointment was prolonged from time to time because of the war and the difficulty of finding a successor. As a reward for his distinguished service he was admitted a Companion of the Indian Empire in June 1918.

As a scientific worker Dr. Barber was distinguished for accuracy and method. He was possessed of enormous industry. The series of Memoirs on sugarcane published by the Department of Agriculture are a mass of accurate information on the subject, while his observations and conclusions have been tabulated with such precision that his successor will have no difficulty in taking up the work at the stage at which it was left. By his retirement Government has lost a worker of first class distinction, but it is to be hoped that we shall indirectly, for many years to come, benefit from his work.

Barber was possessed of a very fine physique and had a distinguished athletic record. At school he was a successful sprinter, while he won his colours at cricket and was one of the football captains. At Christ College, Cambridge, he won his colours for tennis and for Association football and was first in the high and long jump in the college sports. At Cooper's Hill he played regularly in the football and tennis teams. On the æsthetic, as opposed to the athletic, side, Barber was no less distinguished. He was a first class photographer and also did a considerable amount of painting, appearing frequently in the prize list of the Madras Fine Arts Exhibition.

Barber was no less happy in his home than in his official life, and many of us will remember with pleasure the kindly hospitality extended by Dr. and Mrs. Barber to visitors to Coimbatore. It is difficult to realize that the age limit forces on to the pension list

men with such reserve of energy or so physically fit as Dr. Barber was when he left India, and we look forward to seeing further scientific contributions from his pen compiled in the peaceful and congenial atmosphere of Cambridge. We are sure that the good wishes of all members of the department follow Dr. and Mrs. Barber in their well-earned retirement.

CO-OPERATIVE LAND MORTGAGE CREDIT FOR INDIA.

BY

H. R. CROSTHWAITE, C.I.E.,

Registrar of Co-operative Societies, Central Provinces and Berar.

It is not by augmenting the capital of a country, but by rendering a greater part of that capital more active and productive than would otherwise be so, that the most judicious operations of banking can increase the industry of the country. [“WEALTH OF NATIONS.”]

WITHIN the short space of a decade and a half the co-operative credit movement has made phenomenal progress in India. That fact it is impossible to dispute. True, there are those who lament the slowness of development. In opposition to them, critics have come forward to pounce upon a comparatively few instances of failure as proof of an unhealthy desire to show big results in the shape of what is termed “an imposing array of figures.” “You are going too fast!” groans the one school, forgetting that if an aeroplane had never crashed Alcock and Browne could not have flown the Atlantic. “Hurry up!” grumbles the other, being in the happy position of watching people work while it does the talking. But, if there is any truth in the statement that the co-operative movement has been forced ahead too fast, then who, it may be asked, has made the pace? Certainly not the Registrars of Co-operative Societies, nor the small number of men working directly under them. Once started on its way by Government, the movement has gathered impetus, as Government hoped it would. Its finance is already far too big a thing for the commercial banks to

handle. More than that, the amount of money required by co-operators is so enormous that it is impossible for the State to assume any specific responsibility for the safety and solvency of their institutions. What right, indeed, has Government, an entity which is responsible for every part of the body politic, to guarantee the solvency of one particular part of that body without the intelligent consent of the other parts? The tax-payer's money goes into one common purse; and as it is for their own benefit that men join co-operative societies, it is difficult to understand the argument that it is right to rob poor A, who is a private trader, in order to reward B, who is already trying to diminish A's profits—and incidentally put money in his own pocket—by means of co-operation! The simple fact is that the co-operative credit movement is spreading in India because, by means of good organization, it can provide borrowers with credit on reasonable terms and, at the same time, offer a safe investment to lenders. Incidentally, the organization of small credits has been of great service to the country because it has brought into circulation a vast amount of idle money; and it is in this direction, and not in adding to the strain to which the Presidency and other trade banks are subject, that further development is to be looked for. Sound economy and good morality march together, and it is not, as a rule, until a man has reaped some material benefit from listening to the advice of others that he is in a frame of mind to consider their professions of anxiety for his moral welfare. Money is said to be the root of all evil; but everybody wants to have the tree in his own garden. We may, therefore, bear with good-humoured tolerance the disparaging remarks of persons who affect to despise the quality of the co-operative movement in India because it has not converted human beings into saints. We can, also, neglect the views of those who urge that co-operative land mortgage is a sordid business which it is impossible to turn into a means of moral education, and that *for this reason* it should not be attempted. What it is necessary for the political economist to examine is (i) whether co-operative land mortgage can benefit India, (ii) whether, and under what conditions, this particular form of co-operative effort is possible in India, and (iii) whether the enormous sums of

money which are required for organized land mortgage credit can be found in India. In discussing the questions thus raised it will not be necessary to weary the reader by any very detailed references to the methods employed by other countries.

The problems of India are peculiarly her own and bewilderingly complex. Land tenures vary from province to province and from district to district. But wherever a local law debars a holder of land from registering a deed of mortgage in respect of his rights, it is obvious that any kind of organized mortgage credit is impossible. The differences between co-operative credit, of the type which is based on personal knowledge and proximity, and co-operative land mortgage credit are radical in kind. The former, being based on the credit of character, is ephemeral, and is, therefore, unsuited to the making of initial contracts the terms of which cover long periods. The latter, being secured by real estate, is stable enough within the limitations imposed by prudent valuation and the credit of Government. The man who lends upon the security of land, with a tolerably wide margin between the amount he lends and the value he places on the land, is safe enough unless a wave of Bolshevism engulfs his investment. The same cannot be said of the lender who makes a long-term loan on the strength of personal character pure and simple. True, a co-operative credit society, of the type which pledges the unlimited liability of all its members, does back its debts with some real property. But just what that real property may happen to be in the event of forced realization is problematical at any time, and, in respect of a distant future date, is extremely problematical. The asset of character implies the possession of earning capacity, and it is, therefore, an asset which is peculiarly liable to deterioration and which, from the lender's point of view, must be carefully watched. An epidemic of influenza or of cholera may cause a flourishing society to disappear simply because the members who were its strength and support have left the world. Shocks of this kind are provided for in the various systems of personal co-operative credit by a large paid-up share capital, by reserve funds, bad debt funds, and other financial devices.

But the essence of the systems which are based on combinations of personal liability is really this. Borrowed money must be profitably used and paid back out of profits with the least possible delay. It must be understood, also, that the capital turnover of the provincial and central banks which serve rural credit societies cannot be as brisk as that of the banks which serve commerce, for the cycle of agriculture includes crop failures as well as bumper harvests. Nor yet can that same capital turnover approach in ease and rapidity that of a bank suitably designed for the purpose of granting land mortgage credit ; and, as, even with the best of good fortune, short-term agricultural loans have an uncanny way of becoming long-term ones, it behoves the directors of provincial and central banks,—banks designed for a certain class of work only,—to guard against the dangers which arise from locking-up too much of other people's money. To attempt to turn central and provincial banks of existing types into co-operative land mortgage credit banks would be an experiment attended by numerous dangers, and the wisdom of any such step may well be doubted. In addition to the financial difficulty just indicated there may be mentioned the problem of land valuation. A big landed estate is, in India, frequently valued by the simple process of taking a low multiple of the land revenue assessed upon it ; and the same method has, at times, been employed in Germany and other countries. But, as we all know, this method of valuation is, at best, a rough and ready one. It has this virtue,—it will not, as a general rule, overvalue the property. On the other hand, it is defective from the borrower's point of view because it deprives him of the benefit of the true money equivalent of his estate. Half a loaf, in the shape of an inadequate loan, is not always better for the borrower than no bread at all. There are many men who, finding themselves in financial trouble, pay off the most importunate of their creditors by borrowing where they can. They go down the road to ruin by stages, as it were,—each stage more expensive than the one before it. Their interest charges increase, they have to fee lawyers and to keep up an appearance of prosperity lest it may be supposed that they have reached the end of their financial tether.

For such men, the relief obtained from commercial banks and private lenders is, as a rule, of a temporary nature. We cannot blame the commercial banks and private lenders; their point of view is the ordinary business one. They are intent on making money for themselves or for their clients, and the moral and material benefit of the borrower is not their affair. Bitter experience has taught them how difficult it is to value agricultural land; how troublesome it is to bring it to sale; how large the margin between loan and assumed value must be. They know that, as a rule, they cannot avail themselves of that proximity which alone can produce an accurate appreciation of borrowing capacity. These are some of the disadvantages of lending money on large estates, and they become very much more formidable in the case of small ones.

Next, let us glance at the circumstances which affect the market value of small holdings. First of all, there is the productive capacity of the soil which often varies from field to field. Then, there is the fact that the average value of an acre of land in a village area is based, as a rule, on a very wide range of values. The parcel of land in question may be split up, and usually is split up, into bits and is scattered over the village area. One field may be close to the *basti* and exceptionally valuable; another, on the fringe of a patch of jungle, may be ravaged by wild pig; the crops grown on another may, for some mysterious reason, be peculiarly subject to wilt. Add to these sufficiently formidable complications those which arise from the vagaries of the many laws which govern the conditions of land tenure, and the lending of money on the mortgage of small holdings stands revealed as a very dangerous kind of business for those who, lacking the needful equipment, would go in for it on a large scale. On a small scale, and in cases in which full local knowledge is available, it is probably safe enough for parsimonious lenders,—but whether it is to the ultimate benefit of a borrower to execute a first mortgage in consideration of a loan which is small in proportion to the credit which his land can support, is another matter. In particular, although a man who wants certain fields

in order to cultivate them himself, can always get his money back unless he has been led astray—as sometimes happens—by miscalculations caused by an unreasoning hunger for land, prices secured at court sales and, as a last resource, cultivating profits are notoriously small when an absentee owner, whether a bank or an individual, is forced into reluctant possession. There is, for instance, the classic instance from Germany, in which a co-operative society found itself the proprietor of a theatre and of dwelling houses saddled with heavy charges. If, then, co-operative central and provincial banks, designed for the express purpose of dealing in personal credit, are misled by sentiment or bad advice, and, in the end, find themselves in possession of villages, houses, and land which they cannot maintain but must sell, there will indeed be some bargains on the market. But the people getting the bargains will do so at the expense of the banks. As for the banks what, it may be asked, was the ultimate fate of the foolish virgins in the parable? And, on the other hand, what of the over-confident borrower who has mortgaged his land for inadequate consideration, and then finds himself deprived of further credit because the lender does not wish, or does not find it convenient, to reduce his original margin of security?

However, let us attempt to find some way out of Indian difficulties and find answers to the three questions already stated. Firstly, “Can co-operative land mortgage benefit India?” To this there can be no hesitation in replying that undoubtedly it can. For the improvement of agriculture, for the adoption of machinery and modern methods, the employment of capital is necessary; and there must be many owners of considerable estates, whether in the shape of large home-farms or otherwise, who would like to turn the expert demonstration and teaching of the Agricultural Department into something concrete, and of direct personal interest, in the shape of additional income. Modern farming, however, is a business which must be supported by plenty of ready money; and cash in hand seldom figures as one of the main items in a landholder's balance sheet. Then, again, many a landholder, solvent enough at present, has contracted a mortgage debt on conditions

which he finds far more onerous than he expected. For him, the amortisation of existing debt on easy terms must precede any investment of capital in agricultural machinery, in wells, in pumps, in large quantities of manure. There are at least three great problems which India has to solve if she is to develop into a well-balanced country. One of these is the increase of her population in order to supply labour for industries ; another is the increase of her food supply in order to feed an industrial as well as an agricultural population. It is not necessary, surely, to elaborate the argument that capital will be wanted, in very large amounts, by the land, which, if it is to meet a growing demand for food, will have to be made far more productive than it is at present. The third problem is that of prices. Unless industrial expansion is accompanied by the intensive development of agriculture, the price of food and wages will rise to such an extent as to prejudice the sale of the products of Indian industry. There has never yet been a country which could confine its trade to itself ; the different classes of which could live, as it were, by taking in each other's washing. India will certainly want to buy from and sell to other countries ; and, in the vortex of world trade, the prices at which she can sell will be limited by competition. Agricultural credit is, therefore, a subject which demands the closest attention, for it is, in fact, the foundation on which the future of India is based.

The second question with which we have to deal is whether, and under what conditions, co-operative land mortgage credit is possible in India. This form of co-operative effort is, of course, possible. But such a statement rests on several important assumptions. It must, for instance, be taken for granted (i) that the laws of the land will be modified, where necessary, so as to favour an organized system of land mortgage credit, (ii) that owners of land will combine with each other in order to better their credit because they understand (a) the necessity for intensive cultivation, and (b) how to cultivate intensively, and (iii) that the necessary organizing agency is placed at the service of landowners. It is easy to argue that if landowners cannot organize themselves nobody else can do it for them. The argument is a resounding one which appeals

to vested interests and to overworked officials. It belongs to the same family as the statement that "Nature abhors a vacuum"—which served the purposes of Natural Philosophy for nearly two thousand years until Galileo observed that water could only be raised to a limited height by the creation of a perfect vacuum. But it does not fit in, somehow or other, with the lessons which the war has taught us. The scunder point of view appears to be that which envisages the imparting of all essential education as a duty which the State cannot shirk, and which understands that the question of a country's food supply is one which cannot be neglected with impunity. The justification for the existence of a department of agriculture is that it provides a means of education,—not that it can till the fields itself but that it can teach the cultivator to obtain heavier crops. Food being a necessity for all men, and the State being merely another name for its inhabitants, measures to make food better, cheaper, and more plentiful are essentially the business of the State. For this reason, public money is rightly invested in State departments which educate the producer to better business, better farming, and better living. It is the special work of such departments to inculcate the principles of self-help, and to train and strengthen certain parts of the body politic so that there may be a contented and prosperous whole. It is certainly not the legitimate business of any Government department to weaken the body politic by spreading economic fallacies,—by teaching ignorant people that State help, whether in money or in service, is a substitute for self-help. If the members of a family say, each one of them to himself, "I need not work. The rest of the family will feed me," that family must consume either its savings (if it has any), or its borrowings, or exist on charity. In the end, the members must produce food or starve. And in the task of production every member ought to take a suitable part. The economy of a State is very like that of a family. Before proceeding further, then, it may be postulated that the introduction of a regular system of land mortgage credit in India will certainly require State guidance and supervision, but not State money whether in the shape of subsidy or loan. The success of a land mortgage credit association depends

entirely upon the capacity of its members to manage their own affairs up to a certain point. Beyond that point, a system of co-operative mortgage credit becomes the business of the State and merges in the general scheme of State finance.

Societies dealing in co-operative mortgage credit have a semi-official character. They work under Government supervision and inspection, though their members do the detailed work themselves. In case of non-payment by a member they have the right to proceed to the administration of the mortgaged lands or to compulsory sale by auction, without recourse to the law courts. But the levy of a fine or penal interest always precedes drastic action. The servants and officers of the societies are indirectly servants of the State, and generally they have authority to sign certain public documents, such, for instance, as the certificate required before summary procedure is taken. The universal type of co-operative land credit society is a non-profit seeking association of proprietors of land, organized for a province or for some other administrative unit. Individuals become members when the association becomes a mortgagee of their property. Membership ceases with the redemption of the mortgage. Just as in all other co-operative credit the main merit of this particular form of it lies less in the substitution of wholesale dealing for retail, than in the interposition of a body between borrowers and lenders, which, although composed exclusively of borrowers, has a supreme interest in safeguarding lenders. As a class, all co-operative land credit societies have in their organization and in the management of their affairs certain features in common. Their object is to obtain for their members the credit they require by means of bonds, freely transferable and readily negotiable, which the holder can convert into cash, at any time if he sells in the open market, at six months' notice if he demands payment from the society. To provide for demands of this nature (a) reserve funds are accumulated, (b) the right is sometimes retained to charge mortgagor members the same rate of interest as a society may have to pay for loans taken and consequent on such demand, (c) members undertake a limited liability for supplementary contributory payments (as temporary accommodation to the

society) amounting to from 5 to 10 per cent. of indebtedness incurred. Methods (b) and (c) are not common, (a) being sufficient as a rule, as all sinking fund payments,—*i.e.*, payments towards the fund which accumulates at compound interest and from which the debts of members are extinguished by the society,—are made available as a reserve not only for this purpose but to meet claims put forward by bondholders whose bonds have matured, should the collections from members fall below the requisite amount. By this means the society gains time, and keeps neither its members nor its creditors waiting for cash. Formerly, a society's bonds were guaranteed by the landowners of the province or unit collectively. In some of the oldest European countries this collective guarantee is still in force, either for all the estates entitled to obtain mortgages or for the estates actually mortgaged. It seems improbable that Indian landowners, even though close neighbours, would ever consent to furnish a collective guarantee; and it is, therefore, satisfactory to be able to record that, in the more modern societies, the specific security held by the society for its loan, *plus* a limited contributory guarantee, is considered all that it is necessary to ask a member to provide. The latest type of society appears to favour the initial guarantee which is furnished by a substantial share capital, but this, also, is a development which would probably be unsuited to Indian conditions. In all societies the supreme authority is vested in the general meeting of the members. Then come the central committees of management, and then the local or district committees. The Syndics, or expert legal members of the committee of management, conduct the current business of the society. They are paid and, in most cases, are bound exclusively to the service of the society. The landowning members of the committee are generally unpaid. The task of land valuation is performed by the Local Committees who are selected from members resident in the neighbourhood of the land to be valued and not very heavily in debt to the society. Local knowledge, in fact, is always made the utmost use of. To be quite safe, no society grants loans in excess of a certain proportion of the valuation made on the land, the usual limit being 66 per cent. Great care is taken to see that payments

both on account of interest and amortisation (or to sinking fund) are regularly made, and that mortgaged property is not allowed to deteriorate. On the other hand, if the objects stated by the borrower are approved and the valuation shows that the security is good, loans are never refused and cannot be called in suddenly except, of course, as a penalty for misconduct. The mortgagor is at liberty to redeem his property before the date stipulated and, in fact, he can repay as fast as he likes. Members who borrow have to make certain contributions towards working expenses and reserve fund—the “reserve fund” being, in the case of these societies, something quite different to the permanent and indivisible reserve fund of the Raiffeisen system. Loans are paid to members in bonds not in cash. The borrower either disposes of the bonds in the market, or, in those cases in which the societies have established their own special banks, takes them to the society’s bank for sale or for pledge against a loan. Holders of bonds issued possess no right against any specific real property, but only a right to recover from the society. Conformity between bonds and mortgage claims is, however, fully secured; bonds do not become legally valid documents until completed by the supervising officials, upon whom it is incumbent to ascertain by inspection of the public register of title that a like amount is secured by mortgage upon property and that such mortgage claim is also definitely assigned to meet the bond claim. In face of this assignment the registry official may only cancel the mortgage charge on proof that bonds of like value have been withdrawn from circulation. Bondholders have not, however, claims against specific properties thus mortgaged and earmarked; the method indicated merely guarantees that there are never more bonds in circulation than are covered by mortgages, and that other credit operations likely to weaken the security of the bonds are not undertaken by the societies. First mortgages only are dealt in; but societies grant loans to pay off previous mortgages. The bonds, as ought to be the case in British India, are legally recognized as trustee securities. Issues of bonds are made in distinct series; every series carries the same rate of interest, and is dealt with as a distinct issue, having its own management fund,

reserve fund, and sinking fund. In order to float the bonds the societies have united to form their own special banks which are more or less under State control, are recognized as places for the deposit of trust moneys, and are not conducted for the sake of profit. All the profits made by these banks, which are at liberty to engage in any banking business which is not speculative, go to the reserve amortisation funds of the societies. The regulations concerning amortisation differ widely. It is, however, the general rule that the contributions towards redemption are not applied to the immediate reduction of the debt, but are accumulated in a special fund. The fact that most societies allow the withdrawal of accumulated contributions or readily grant fresh mortgages prevents the proper aim—complete removal of indebtedness—from being realized. On the other hand, it is urged that, unless such facilities are granted, landowners may be obliged to seek mortgage credit elsewhere and on more unfavourable terms. Various proposals have been made to secure complete removal of indebtedness; one, for instance, is that the mortgagor should pay an insurance rate for a redemption policy in addition to his annual amortisation payment to the sinking fund; another that the amortisation payment should be devoted to a life insurance policy.

The principal merits attaching to a mortgage credit association as an agency for providing the landowner with long-term credit may be summarized as follows:—

- (1) They enable landowners to mobilise the wealth represented by their landed possessions by the creation of bonds passing into the general system of securities. These bonds are not, like an ordinary mortgage security, of very restricted currency but are realizable at any time in the open market.
- (2) The loans granted are not subject to recall.
- (3) The rate of interest is as moderate as possible—far more moderate than the borrower could secure if single handed, and is regulated by the market rate.
- (4) The rate of interest cannot be raised.

- (5) The right is conceded to reduce the debt by payments made at the mortgagor's convenience.
- (6) The necessary extinction of the capital debt is accomplished gradually.
- (7) The costs for valuation and other charges are low.
- (8) The administration is at once relatively inexpensive and the officeholders highly qualified for their work.

Even this cursory examination of the machinery for co-operative land mortgage credit will, it is hoped, show that there is nothing to prevent the establishment in India of societies and banks for this special work. It may be exceedingly difficult to organize and start such societies and banks; but that is no reason for not starting them. It may be that landowners will, at first, view the new idea with suspicion. That, however, is not an excuse for refusing to take action. It may be that the State will have to appoint special officers to organize and assist this very difficult branch of co-operative work. That, however, is exactly what other countries have had to do. The co-operative movement in India is still too young to be able to think out for itself advanced applications of the main principles upon which all forms of co-operation are based. And in order to organize mortgage credit societies and to manage the special banks there must be skilled and experienced men who will devote their undivided attention to the work. It is not understood, perhaps, that banks of the kind we are now discussing can discount the paper of the existing types of central banks and rural credit societies and can, under certain conditions, make loans to them, adding profits to their own fund for debt extinction and thus making agricultural money help agriculturists. It is, in fact, only by making the fullest use of the solid backing which landownership gives to their operations, a backing which is particularly acceptable to trustees, banks, corporations and to all investors who make security their first consideration, that the members of co-operative mortgage credit societies contrive to provide themselves with long-term credit at very moderate rates of interest. That the credit obtained is for long terms may be gathered from the fact that amortisation payments are frequently as low as half per cent. per annum.

The question which remains is "whether the enormous sums of money which organized land mortgage credit requires can be found in India." In considering this question, it must be remembered that mortgage credit societies are eminently suitable as a means of substituting debt on reasonable terms for debt contracted on terms dictated, perhaps, by dire necessity or the folly of an ancestor. The end in view is, in substantial part, not so much that of creating fresh capital as of a redistribution and economic adjustment of capital already sunk. Looked at from this point of view, the bearing of a well-organized system of mortgage credit upon industrial and commercial development becomes clear. It was clear enough to the Germans; and though Germany has been beaten in the war, only the purblind will refuse to believe that, in many respects, German industrial, commercial, and agricultural organization and method had many lessons to teach to the world. Germany lost the war because her cause was cruel, selfish, and bad, and because, blinded by pride in her own achievements, she failed to appreciate the moral no less than the material might of the British Empire with its very much longer, less calculating, and infinitely more humane history. Germany, the Germany of the Hohenzollern dynasty, set out to conquer the world. It was an adventure that was doomed to fail. Had it succeeded, success could only have been for a time. The very fact that Germany's attempt upon human freedom has upset the world's balance should make us understand that German domination would, sooner or later, have brought about a veritable catastrophe. Looking to the future, it is evident that the countries which have the most to hope for and the least to fear are those which are ready to understand the necessity for internal organization. Departments of industry, commerce, agriculture, and education must have their essential complements in the shape of departments of finance. And, in India, there is scope enough for the organization of finance.

Speaking from personal experience, I have seen one small provincial co-operative credit banking organization, guided by a very meagre number of officials and non-officials, accumulate a working capital of more than a crore of rupees,—and that within a

period of fifteen years. Given sufficient staff for propagandist work and for teaching and training, there is firm reason to believe that co-operative finance can be made to keep pace with, and to accelerate the pace of, general progress. It is certain that without improved finance, the efforts of such departments as those of agriculture and industries cannot meet with anything but a superficial success. The question is really an administrative one, and resolves itself into the fashioning of a lever, big enough, but no bigger than necessary, to raise a weight which is imponderable. Paradoxically, the heavier the brains of the weight, the lighter and less expensive need the lever be. Hence, the conclusion may be arrived at that all reasonable and prudent expenditure by the State upon practical education—the right kind of education given by competent persons—is, in reality, only the premium for an endowment insurance which will mature and, in the end, do more than merely recoup the State.

Within the space of an article such as this it is not possible to make more than a passing reference to the very large sums of money which lie idle in the Government Treasuries during certain months of the year, to the notorious manner in which India absorbs and withdraws from circulation vast quantities of gold and silver—an absorption which even the ancient Romans found it necessary to protect themselves against by prohibiting the export of gold to this country,—and to the fact that Indian exports exceed imports. In addition, it must be pointed out that the essential function of co-operative mortgage credit banks is to convert funds which have been locked up and have become immobile into a form of security which is readily negotiable and is, therefore, fluid. Split into bonds of small denomination and in the hands of many holders, landed securities become something differing as widely from the usual mortgage lock-up as the silver rupee is distant from the Sanskrit *rupya* (meaning a herd or flock) which is its direct but remote ancestor. In the course of trade, amongst enlightened people, mortgage bonds can be made just as good a medium of exchange as currency notes, and can be backed by a reserve of real estate instead of by a metallic reserve. Lastly, as the industries and agriculture

of India become more and more productive, the amount of money in circulation will certainly increase. On the whole, therefore, it is safe enough to conclude that there will be no lack of money, for, as a system of organized land mortgage is gradually developed, production and consumption will increase, and industries and trade will flourish.

A NEGLECTED SOURCE OF SUGAR IN BIHAR.

BY

MANMATHANATH GHOSE, M.A.,

Assistant Professor of Chemistry, Agricultural College, Sabour.

BENGAL has a considerable industry in date-palm sugar, but no great attention seems to have been paid to the palmyra palm as a sugar-producer. Nor has it received any recognition in Bihar where the richly saccharine juices yielded by this tree are converted into toddy which supplies a cheap intoxicating drink for the lowclass people. The tree flourishes fairly abundantly and if the juice is collected judiciously it can supply a large part of the sugar consumed by the people. Not even 10 per cent. of the trees are tapped, so that, even allowing the people their drink, a considerable commercial possibility exists, and in April and May when the flow of the juice is most abundant, toddy sells so cheap that there can be little doubt that the manufacture of sugar will pay. In the Madras Presidency large quantities of sugar are annually produced from this source and though its commercial success is assured there, the climatic conditions of Bihar being apparently different from those of Madras during the juice-yielding season, it is considered worth while to study the question here.

Tapping. The method of tapping is important, as on it depends the flow of the juice. In the female tree, after the fruits have just begun to form, the flowering stalk is rubbed with a rough skin detached from the leaf-stalk and is then struck with the back of the tapping knife, the object being to destroy the fruits and to provide a local irritation which is perhaps necessary to encourage the flow of the juice. The spaces between the fruits are



Fig. 1. The *pasi* (toddy-collector) at work: squeezing the male fingers.

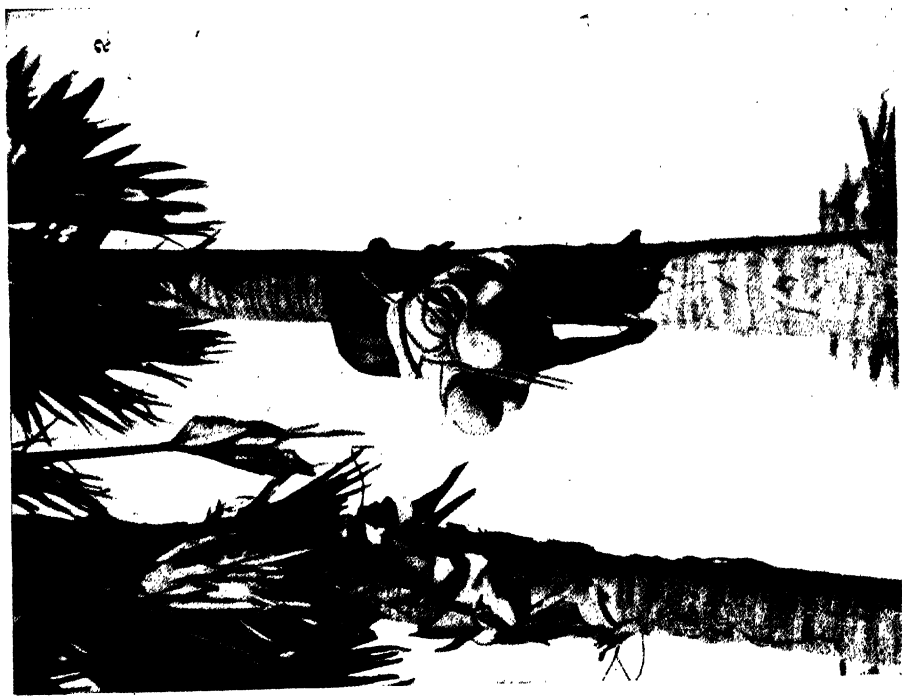
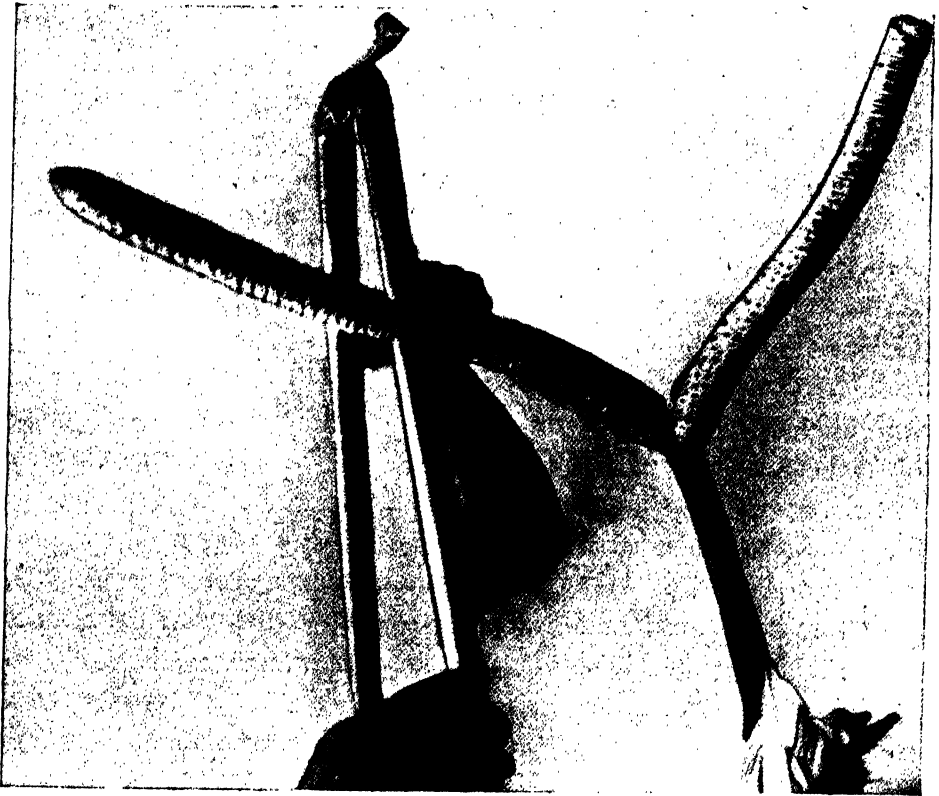

Fig. 2. The *pasi* climbing the tree with six *labnis* (pots) and *danta* (an improvised pair of tongs).

rubbed with care and force and in the end the tip of the stalk is cut off. The toddy-collector, or the *pasi* as he is called in Bihar, then waits for some time, cutting every day the end of the stalk about three times. In three or four days, juice begins to drop. The inflorescence of the male trees is subjected to a harder treatment. The finger-like bunches on which flowers appear are squeezed along their lengths (Plate III, fig. 1) by an improvised pair of tongs (locally called *danta*) formed by two sticks, about a foot long, one



The *danta*—an improvised pair of tongs used for squeezing the male fingers.

end of which is tied together by a string. This requires experience and technical skill, as too gentle a pressure will not make the juice flow, and too hard a pressure will destroy bunches and make them dry. The *pasi* is always careful not to begin the squeezing operations till late in the afternoon when the temperature has gone down

as otherwise the wounds inflicted will kill the delicate fingers. The tips are then cut off and the fingers are at once collected together and let into the mouth of an earthen pot in which the juice afterwards collects, in order to protect the portions, exposed by cutting, from getting dry. The secretion of the juice generally takes place in the course of a week and, during the whole period the juice is yielded, the tips of the flowering stalks must be cut twice a day. Occasionally, while the flow of the juice is going on, a dark spot appears on the clean cut surface of a finger as the result of previous injury by the *danta*. The finger then ceases to yield juice, but the flow reappears when the affected portion is cut off.

Flow of the juice. The flow of the juice is apparently regulated by the heat of the day and the weather. Shady trees, as a rule, yield more juice than those of which leaves are cut. Careful attention must always be paid to see that the juice-yielding bunches and stalks are protected as much as possible from direct sun's rays. Weather is, perhaps, the most important factor in determining the yield. Unlike the date-palm this tree yields juice at a time when sudden changes of weather are frequent. When the trees are in full inflorescence, dry west winds usually blow and the tapping operations should, as far as possible, be done before the weather has changed. Any bunches that survive the preliminary treatments and begin to yield juice at this dry weather, are expected to yield copious quantities when the atmosphere becomes humid. If, however, the operations are done in moist weather with damp east winds blowing, the juice, though at first abundant, is liable to diminish considerably and cease altogether when a change back to a dry wind and high temperature, lasting for days together, takes place. A reference to the yields of the trees S₁ (v) and S₂ (v) will make this clear. These were male trees tapped for the first time, just when some local showers of rain had caused the previous dry weather suddenly to change to a moist one. The collections were good at first, and up to the time when the maximum day temperature was not higher than 100°F., but as the heat increased and the temperature remained very high for three days together, a sudden diminution of the quantity took place from 2,200 grm.

(in tree S₂) on the 8th May to 300 grm. next morning and to almost nothing afterwards. Compare this with the results of SiF, which was tapped earlier and in the dry season. The latter was yielding profuse quantities when the two former dried up.

Table of yields.

		S ₁ (v)	S ₂ (v)	SiF ₁	Maximum temperature	Minimum temperature
		grm.	grm.	grm.	°F.	°F.
4th May	Morning	2,850	2,400	6,300	90	74
	Evening	1,050	840	3,400	100	75
5th May	Morning	2,900	2,000	6,600	83	71
	Evening	1,200	680	3,400	100	78
6th May	Morning	3,000	1,600	6,850	80	71
	Evening	1,600	740	3,700	103	75
7th May	Morning	3,000	1,250	7,800	97	71
	Evening	1,500	670	4,100	109	79
8th May	Morning	2,200	340	7,950	96	73
	Evening	550	nil	4,800	120	78
9th May	Morning	300	nil	7,650	93	65
	Evening	negligible	nil	4,800	115	87
10th May	Morning	nil	nil	7,550		
	Evening	nil	nil	4,700	123	87

Our experiments were carried on with 17 trees of which ten had never been tapped before and a few of the latter were also not sufficiently shady. As a result, we did not obtain a very large quantity of the juice, but learnt enough of the habit of the tree to arrive at the following conclusions: The quantity of the yield is different with different trees. Of the trees which were tapped for the first time, a good many yield no juice in the first year and others yield only a small quantity at first, but in two or three years they improve and then begin to yield the maximum they are capable of. In good trees a quantity of 5,000 to 7,000 grm. of juice, morning and evening, can be expected in the beginning, *i.e.*, from the middle of April till the end of May. In June the flow begins to diminish gradually to about half the quantity, and finally in the beginning of July the yield dwindles down abruptly to a negligible quantity. There are male trees which give out a second inflorescence and yield a second crop of juice, and there are also some female trees in which the juice comes out after the fruits have grown big and some in which when the fruits are nearly ripe, but as their number is not

very great, they have been left out of account. When a tree is to be tapped care should be taken to leave out of account those bunches which are not shaded from the direct rays of the sun and are thus not kept cool. As has been said, too high a temperature of the flowering stalks or bunches hinders the flow of the juice. One will very often come across trees almost denuded of leaves by poor people who cover their huts with them in the absence of more expensive straws. Such trees should best be left alone.

Collection of the juice. The collection is made twice a day morning and evening. The evening collection, which consists of the juice yielded during the day, is necessarily much smaller than that collected in the morning on account of the high temperature during the day. In the date-palm, all the juice of any one tree collects in a single pot, but in the palmyra palm, the number of collecting pots attached to a tree depends upon the number of juice-yielding flowering bunches or stalks, and it is a common sight to see five, six, and even eight pots attached to a single tree. The juice-collector fixes in his waist-band or belt a hook from which as many as six or seven *labnis* or pots can be conveniently suspended, and the man feels no difficulty in climbing up the tree with the pots hanging from the hook behind (Plate III, fig. 2). As the juice-yielding season coincides with the hottest part of the year the juice seldom remains fresh if collected in pots without any treatment. As the practice in Bihar is to collect the fermented liquor, the pots are purposely kept dirty with even yeast added so as to present conditions as favourable to fermentation as possible. Experiments have been conducted in Bengal with pots variously treated for the collection of fresh date-palm juice.¹ It was found that smoked pots preserved the juice when the temperature was low, but pots the inside of which was coated with lime could be relied on at all temperatures. Even in Bihar, with the palmyra palm, we found that early in the season, at low temperatures, the juice in smoked pots gave a sucrose content, often comparable with, and at times higher than, that in limed pots. The juices in the limed

¹ *Memoirs of the Department of Agriculture in India, Chemical Series, vol. V, no. 3.*

pots, however, kept remarkably fresh at the highest day temperature and there was no sign of inversion, the amount of glucose, found at any time, being practically negligible. Little changes were observed in the composition when the limed juice was kept overnight. This preserving action of lime is, however, not shared by the carbonate. The juices collected in the pots coated with a thin paste of finely powdered chalk were mostly fermented during the day, and were so slimy that no readings could be taken to find out what amount of sucrose was still left.

The loss of sugar due to the combination of lime with sucrose is not much. The exact amount was not, however, measured. The limed juice, on standing, gave a clear yellowish liquid with flocculent white precipitates settled down, much of which consisted of unchanged lime from the linings of the pot. When, however, coarse grained lime was used, *i.e.*, lime which was not very well slaked, the precipitate refused to settle down and a clear liquid was not obtained. This was witnessed also when the juice was comparatively poor in sucrose, especially when the juice, owing to an insufficiency of lime, had just begun to ferment. The reason in the latter case probably was that the calcium saccharate formed was breaking up by the action of carbon dioxide evolved during the fermentation, and the milky appearance of the juice was due to the finely divided lime compound which took long to settle down. The lime used should therefore be well slaked and a too great excess should be avoided.

Composition of the juice. Fresh juice has a sweet smell and an alkaline reaction. Fermented toddy is a dirty foul-smelling liquid, containing, among others, a large percentage of acetic acid, so that it can be of value as a fruitful source of vinegar. The percentage of sucrose, average 12.5 per cent., is remarkably constant throughout the season, and did not show a tendency to increase as the yield diminished. Unlike the juice from the date-palm of which the day juice is apparently richer than the night yield¹, no appreciable difference is perceptible in the day and night collections,

¹ *Memoirs of the Department of Agriculture in India, Chemical Series, vol. V, no. 3.*

notwithstanding the fact that the yield during the day is considerably lower than during the night. Whatever difference in richness has been found can be accounted for as being due to the greater evaporation during the day and the consequent greater concentration of the day juice. The similarity of the day and night juices is illustrated by the table below:—

Tree	Date	Yield	Sucrose	REMARKS
		gram.	Per cent.	
Female F ₃ ...	25-5-18	E 3,000	12·70	E Day juice collected in the evening.
	26-5-18	M 3,700	13·45	
Male S ₃ ...	29-5-18	E 2,950	14·16	M Night juice collected in the morning.
	30-5-18	M 2,225	13·13	
Female F ₃ ...	1-6-18	E 4,100	13·12	
	2-6-18	M 4,500	12·46	
Male S ₃ ...	5-6-18	E 1,400	15·76	
	6-6-18	M 2,700	14·39	
Female F ₃ ...	8-6-18	E 1,700	13·01	
	9-6-18	M 1,800	13·29	
Male S ₃ ...	12-6-18	E 1,900	12·05	
	13-6-18	M 2,050	14·00	

It is also evident that there is nothing to choose between a male and a female tree in point of richness of the juice, and nothing has been found by us to confirm the popular belief that male trees, as a rule, yield more stimulating toddy than females. The juice-yielding period is also the same in both.

Gur. When the supernatant clean juice from limed pots is decanted and boiled, the *gur* (crude sugar) obtained, has, on account of its containing lime, a caustic taste, and is, therefore, unsuited for direct consumption. On, however, passing a slow current of carbon dioxide until all the lime is precipitated, and then boiling the filtered juice, the *gur* obtained is highly sweet and palatable and is remarkable for its lightness of colour and flavour. It is suggested, as in the analogous case of the limed juice of the date-palm, that citric and tartaric acids or the water extract of unripe tamarind fruits may precipitate the lime, and, when used in proper quantities, give the juice a proper acid reaction so necessary to impart a light colour to the *gur*. In the latter case, it would make *gur*-making from palmyra palm within easy reach of all. The ash content of the *gur* lies between 2·5 to 3·0 per cent., and, on account of its containing deliquescent salts, even the driest *gur* absorbs moisture in moist

weather. This property goes against the keeping qualities of the *gur*, as it is then liable to get fungoid attacks. As the *gur* will be made in the dampest season of the weather, this difficulty of preserving the *gur* is a serious drawback against its commercial success. On the other hand, limed *gur*, *i.e.*, that made from the juice from which lime has not been removed, keeps wonderfully well. Though unsuited for being used as such, such *gur* can be used in the refineries for making white sugar. The removal of lime by the introduction of carbon dioxide or an acid involves a loss of sucrose in the *gur*. Samples obtained by us by directly boiling the limed juice contained approximately 85 to 88 per cent. of sucrose, while, when lime was removed from the juice, the sucrose content of the *gur* averaged only 80 per cent. As much as 58·7 per cent. of white sugar has been obtained from a sample of limed *gur* from the date-palm juice.¹ Similar, if not better, results can fairly be expected here also. Chances of inversion and of fermentation are greater in the date-palm juice before it reaches the pot, as the exposed cut surface of the tree is large and the pot too has a wider open mouth. Here only the tips are cut and the exposed surface is well inside the pot and thus protected from the sun, while the mouth of the pot is narrow and almost closed by the bunches.

As the production of palm sugar from the wild date-palms in Bengal has so far been satisfactory and as improvements are being suggested which are expected to yield still better results, it can be said, with sufficient fairness, that the palmyra palms in Bihar might be fruitful sources for the manufacture of cheap white sugar and that the industry is worth giving a trial. In Madras and in Burma, these palms yield a not inconsiderable quantity of sugar.

¹ *Memoirs of the Department of Agriculture in India, Chemical Series*, vol. V, no. 3, p. 97.

SOME FAMINE FOODS IN AHMEDABAD.

BY

G. P. PATHAK, B.A.,

District Agricultural Overseer, Ahmedabad.

IN the west of the Ahmedabad District, or, to be more precise, to the west of the Sanand and Dholka talukas and to the south of the Viramgam taluka of that district, there lies a large depression locally termed the *nal*. This area is waterlogged and contains usually a large lagoon, and has a length of about eighteen miles and a breadth of five to six miles. The villages lying on the border of this waterlogged *nal* are termed the *nalkantha*.

The *nal* itself lies low, and receives nearly all the drainage from the three talukas named during the monsoon, and at that time forms a large lake. The bordering areas are composed of somewhat low-lying flat lands (*kyari*) used almost entirely for rice, of higher black cotton soil usually considered suitable for *wagad* cotton and for unirrigated wheat, and of a certain proportion of light land termed *thalian*, suitable for *jowar* (*Sorghum vulgare*), *bajri* (*Pennisetum typhoideum*), pulses, and *til* or sesamum. The subsoil over most of the area is a yellow earth, impervious to moisture, and the soil is usually somewhat salt with rather brackish subsoil water. The cultivators are chiefly Talabda Kolis, Nadoda Rajputs, and Girasias. The cultivation in the *nalkantha* is fairly good, and the returns in an ordinary year are sufficient for the people. In years of deficient rainfall, the tract suffers badly from want of food and fodder.

Under these circumstances the cultivators, and especially the poorer cultivators, have turned to the *nal* itself for the means of

supporting life, both for themselves and their cattle, and have utilized several materials, an account of which may prove interesting. Those of which I propose to write are—

- (1) *Bid* or the rhizomes of the sedge *Scirpus kysoor*, Roxb.
- (2) *Thek* or the rhizomes of the sedge *Cyperus bulbosus*, Vahl.
- (3) *Poli* of *pan* or the inflorescence of *Typha angustata*, Bory and Chaub.
- (4) The tubers (*kanda*) and (5) the fruits (*lampdi*) of *poyana* (*Nymphaea stillata*, Willd.).

Of these the most important would seem to be the rhizomes of the *bid* plant, a common sedge in the brackish *nal*. The name *bid* is really given to the rhizomes, while the aboveground portion is termed *gundari*. In ordinary years the milch cattle eat the grassy portion of the sedge when green during the cold weather, and it is also employed for thatching the houses of the poorer people. The use of the rhizomes as food and fodder is no new thing. Watt¹ says, in fact, "The roots are dug up in large quantities in the cold weather, sliced and eaten uncooked by the natives of many parts of India. They are sweet and starchy, and are considered cooling and highly nutritious." This year the use of them in the *nalkantha* has, however, been far more extensive than usual.

In order to obtain them, when the water in the *nal* dries up, the land is dug with hand picks or *kudalis*. Then the big clods are broken down with a wooden hammer, and the *bid* with the roots attached is taken out and heaped into a long ridged heap, covered with the dried *gundari* and other materials. These inflammable materials are then ignited in order to burn up the roots adhering to the *bid* rhizomes and to facilitate the removal of the attached earth. The process of covering and burning is repeated, if necessary. The resultant product has been sold at eighty to one hundred pounds per rupee during the present year.

The product is not yet, however, free from earth, and hence, before feeding to cattle, the material is steeped some time in water. This removes the earth and softens the rhizomes, so that when the

¹ "Dictionary of Economic Products of India," vol. VI, part-2, page 491.

latter have been beaten by a heavy stick to break them up, they can be eaten easily by cattle. The soaking is also of advantage in preventing a loss of the flour contained in them, which would otherwise certainly be partly washed out.

When the material is intended for human consumption, the digging up of the clods containing the rhizomes takes place as previously described, but the clods are left unbroken for several weeks. Thus the rhizomes are dried up thoroughly in the soil and become sweeter to the taste. Then the small rhizomes are separated as described above, and are collected and dried in the sun for four or five days. They are powdered on the ordinary household powdering stone and sifted through a cloth to separate roots and fibres. The dried rhizomes yield about sixty per cent. of flour. The flour is mixed for use either with wheat or barley flour to the extent of from twenty-five to fifty per cent., and the mixture (locally called *setaru*) made into loaves.

On analysis the materials gave the following figures:—

- (a) *Bid* rhizomes prepared for cattle food.
- (b) *Bid* rhizomes prepared for human food.
- (c) *Bid* rhizome flour, for human food.

	a	b	c
	%	%	%
Moisture	3.80	3.00	3.45
Ether extract (fat)	0.90	0.66	0.65
Proteids	7.56	11.81	8.78
Digestible carbohydrates	62.69	69.78	78.82
Woody fibre	14.95	9.65	3.10
* Ash	10.10	5.10	5.20
	100.00	100.00	100.00
* Containing sand	6.30	3.00	0.23

The second of the materials we are considering consists of the rhizomes of *Cyperus bulbosus* locally termed *thek*. Like that of the *bid* rhizomes the use of these is no new thing. Watt (*loc. cit.*) notes that the roots are used as flour in times of scarcity, and eaten roasted or boiled. He states that when roasted these roots have the taste of potatoes and would be valuable for food if they were not so small. Balfour writes as follows:—"Dr. James Anderson in an excursion in the southern part of the peninsula of India discovered that

Cyperus bulbosus, growing in sandy situation by the seaside, and requiring but little water, was the common food of the natives during a famine when other grains are scarce. It is nutritious, pleasant to the taste, and makes a pudding somewhat resembling that made of sago." On the same subject Drury notes that some dry the tubers in the sun, grind them into meal and make bread of them, while others stew them in curries and other dishes.

The *thek* plant naturally grows in the salt lands on the edge of *nal*. When this land is dried up it is divided into small beds ; water is then let in and the bed is dug up under water. Under these circumstances the *thek* roots and tubers separate from the soil, and being lighter, float to the top of the water, and are collected in a sieve made of grass. When thus collected, they are dried in the sun, spread over the ground, covered with any available inflammable rubbish, and the latter burnt. The material thus obtained is then beaten with a stick to remove the coverings of the tubers themselves and a final winnowing gives the fresh roasted *thek*. The *thek* thus prepared is used as a substitute for *jowar pankh** either on fast days or it is sent to market and used by town and city people as a novelty. It cannot be kept long, as it quickly goes bad.

When used for loaf-making the process is different and the tubers as floated out of the ground are only dried completely in the sun and not burnt or roasted. It may then be used alone or mixed with either wheat or barley flour.

The third plant whose use for food in the *nalkantha* has come specially to notice during the present famine season is the common nymphaea water-lily of the *nal*, known locally as *poyana*. Little seems to have been recorded hitherto of this material, but it has been largely employed in the present season as human food in two forms. The first of these consists of the tubers of the *poyana* plant, termed *kanda*, which are roasted in ashes in exactly the same way as is done with onions or potatoes, and consumed in this condition. Though this is the usual method of consumption, yet the tubers are also prepared by boiling in the manner usual with other vegetables.

* Roasted green *jowar*.

The second part of the *pojana* plant used as food consists of the fruits, termed *lampan*, or *jitolan*, and the seeds termed *lampdi* of *lampan*. In order to prepare the seeds for use, the fruits are collected and dried in the sun for three or four days. The seeds are then gathered, and cleaned of refuse by the usual method of the *sup* (winnower), and are finally milled into flour. The flour so prepared is mixed with wheat or barley flour to the extent of twenty-five to fifty per cent. and made into bread as usual. The taste is unpleasant and the smell is objectionable, but the bread made is very light.

The analysis of the tubers and seeds of *pojana* gave figures as follows :—

	a	b
	Dried tubers	Seeds
	%	%
Moisture	4·20	5·40
Ether extract (fat)	0·45	1·30
Proteids	14·56	11·31
Digestible carbohydrates	67·49	70·59
Woody fibre	5·45	7·45
* Ash	7·85	3·95
	100·00	100·00
* Containing sand	0·28	0·45

The *poli* of *pan*, derived, as already stated, from the fibrous rush *Typha angustata*, consists of the pollen from the inflorescence of this plant, which is used as flour. Its use for this purpose has been frequently recorded. It is stated to be commonly employed in Sind, and it has certainly been eaten in various parts of the Bombay Presidency in previous famines. The method of use in the *nalkantha* is to collect the inflorescence in the morning when there is no wind, and then to rub the pollen off on a cloth. The flour thus obtained is moistened with water and made into cakes termed *dhokalan*, which are wrapped in cloth and then roasted over a heated brass vessel. The cakes are sweet, yellow in colour like turmeric, and are quite palatable as human food.

A FEW HINTS ON LABELLING IN EXPERIMENTAL STATIONS.

BY

T. S. VANKATARAMAN, B.A.,

Ag. Government Sugarcane Expert, Coimbatore.

IN every farm where experimental work is being carried on, a quick, cheap and efficient system of labelling is often of very great importance. Occasionally one comes across farms where there are practically no labels in the field, and the officer in charge has to unroll each time a parchment scroll in which the plans of plots and other details are fully entered up. Besides the waste of time involved in the process, the visitor, especially if new, always feels some uncertainty that, in the particular instance, the plan has perhaps not been correctly interpreted with reference to the plots.

The ideal would appear to be to give in the labels as much information as possible. This will enable the visitor to obtain a general idea of the nature of the experiments being carried on without much help from the staff who may not be always available. Again, the members of the staff would be enabled to form certain ideas as to the various plots without always having to carry with them bulky notes and diagrams. It is a matter of common knowledge that while taking an evening stroll along the plots certain ideas force themselves on one's attention much more readily than when the plots are examined with the idea of "study." On such occasions the use of plot labels with full details is obvious.

Owing to the very large number of varieties that are planted at the Cane Breeding Station each year—of late we have been planting as many as 2,000—the need was felt even from the outset

for a cheap and efficient system of labelling. In fact, it is felt that the absence of an efficient system of labelling has been a fruitful source of mistakes in naming in the past. It was further found that the requirements at the Cane Breeding Station were of a varied character, and different types had to be evolved to meet all the requirements.

One of the earliest to be tried was the type represented in Plate IV. These labels consist of pieces of deal-wood from old packing cases thinly coated over with white paint and nailed to bamboo or iron uprights. They are easy to write over with pencil, and retain the impressions fairly well for over a year. The deal-wood boards can be used over and over again by merely cleaning the surfaces—occasional sand-paperying or planing being required in cases where the surfaces are badly injured—and recoating with white paint. The picture opposite (Plate IV) is a photograph of labels of this class. Nos. 1 and 2 are fresh having been in the field only 2 to 3 months, No. 3 is 4 months old, Nos. 5, 6 and 7 over 14 months, and No. 4, 18 months. No. 8 represents what may be called a war-time label. With the scarcity of deal-wood boxes their prices rose very high and an attempt was made to use a thin slice of the bamboo rind with successful results. This label (No. 8) is over one year old and was quite satisfactory at the end of the period.

The white paint used for coating these label boards is easily available from any bazaar and is sold ready mixed in kegs of 8 to 10 lb. When freshly opened the paint is in a satisfactory condition and all that is required is to mix it with a little turpentine. If too much turpentine is added the coating shows a tendency to peel off in flakes. There are many brands in the market and the proportion of turpentine varies with each brand and the condition of the contents when opened. This is, however, soon learnt by experience. To obtain the best results it is essential that the paint should be laid on the labels in a thin even layer. When, by frequent opening of the lid, the paint gets solidified small quantities of linseed oil have to be added and the paste well ground and mixed. Great care should be taken not to mix too much oil or else a glossy surface is produced on which it is difficult to write. Each keg of white

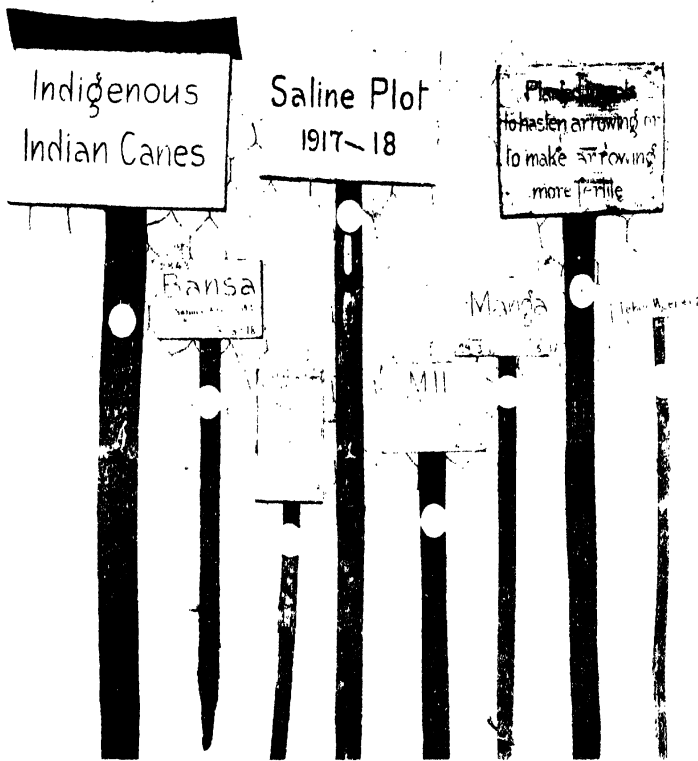

LABELS WITH DEAL-WOOD BOARDS COATED
OVER WITH WHITE PAINT.

Nos. 1 and 2 about three months old; No. 3, 4 months; Nos. 5, 6 and 7 over 14 months; No. 4, 18 months; and No. 8 over a year. In No. 8 the board is made of a thin slice of the bamboo rind.

The zinc board seen over No. 1 is intended to prevent the label surface being soiled with excreta of birds perching on the top of the labels.

point, sufficient to coat 800 label boards 6" × 3½", which previous to the war cost Rs. 3-8-0, now cost Rs. 12. The following statement gives the relative cost of the different types of labels represented in Plate IV.

Statement showing the relative cost of 100 labels of the different types represented in Plate IV.

Sizes	Nature of stake	Total cost per 100	Cost of annual renewal of stakes	REMARKS
		R. A. P.		
Label 10" × 6", stake 4' high	Iron	47 12 0	No renewal needed	} Nos. 1, 3 and 4 are of this class.
Ditto	Pieces of areca-nut palm	9 0 0	3 8 0	
Ditto	Bamboo	7 8 0	1 12 0	
Label 6" × 3½", stake 3½' high	Iron	23 8 0	No renewal needed	} Nos. 2, 5, 6 and 7 are of this class.
Ditto	Pieces of areca-nut palm	5 4 0	2 8 0	
Ditto	Bamboo	4 2 0	1 5 0	
Label 3½" × 1", stake 4' high	Bamboo	1 0 0	These can be used only once	No. 8 is of this type. The label board consists of a thin slice of bamboo rind in place of wood.

Note 1. This statement is based on figures obtained when the Indian market was unaffected by the war but the altered prices chiefly affect only those with iron stakes.

Note 2. The gradual disappearance of the iron stakes led to their substitution by pieces of the areca-nut palm or bamboo.

Note 3. In the above statement the cost of deal-wood boxes is included, but it is to be noted that odd bits of deal-wood are frequently available in any large office.

Note 4. The zinc hood seen over the label board in No. 1 is intended to prevent birds perching on the top and disfiguring the label surfaces with droppings.

Note 5. As a precaution against white ants, portions of stakes driven into the ground should be carefully painted with tar.

It was found, however, that these deal-wood labels were not suitable where a certain amount of detail had to be entered up.

This introduces us to a system of "plot labels," which have been found to be of great use at the Cane Breeding Station. In examining each plot of seedlings, for instance, it was felt that it will be a great convenience to have in the field a plan of each plot together with a certain amount of information about the parents. Reference to lists or papers, while in the field, is cumbersome and liable to miss out important details. Plate V is a photographic reproduction of such labels. No. 1—Fig. 1, and Nos. 1 and 2—Fig. 2, are 6 months old, while No. 2—Fig. 1, and No. 3—Fig. 2, are over 14 months old. The labels when laid down give an exact plan of the plots against which they are placed. These labels are prepared in the following manner. The label is first written with pen or pencil on thin mounting paper or thin cardboard and subsequently dipped in melted paraffin. The pen is not so easy to write with as pencil but the labels are much clearer [Plate VI, fig. 1 (Nos. 2 and 3)]. White paraffin wax 135–140° F. is quite suited for the purpose. The labels should be dipped in paraffin which has been melted for some time,

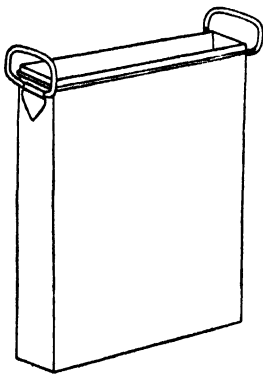

The vessel used to melt paraffin wax in.

and taken out almost immediately. The right temperature is soon learnt by experience. If too hot the label comes out brittle, and if not quite fully and uniformly melted the paraffin shows a tendency to stick to the paper in odd patches. To economize the quantity of paraffin and to avoid the labels having to be bent at the time of dipping—if thus bent the labels show a tendency to return to this shape for a time—it has been found useful to employ a tin vessel shaped according to the sketch in the margin.

Such a vessel, with pieces of solid paraffin in it, is immersed to below its mouth in a bucket of water and the water brought almost to a boil. This melts the paraffin inside the tin vessel and keeps it in a liquid condition for a fairly long time.

The labels after treatment with paraffin are fixed to label boards similar to those figured in Plate IV by means of eyelets and copper

EXPLANATION OF PLATE V.

These labels are made of paraffined paper and are useful in cases where it is desired to enter a certain amount of detail on the labels. These are unaffected by sun or rain and can be washed with soap and water.

No. 1 (Fig. 1), and Nos. 1 and 2 (Fig. 2), are over 6 months old.

No. 2 (Fig. 1), and No. 3 (Fig. 2), are over 14 months old.

The paraffining renders the labels shiny, a serious handicap to a successful photographic reproduction. The actual labels are much clearer.

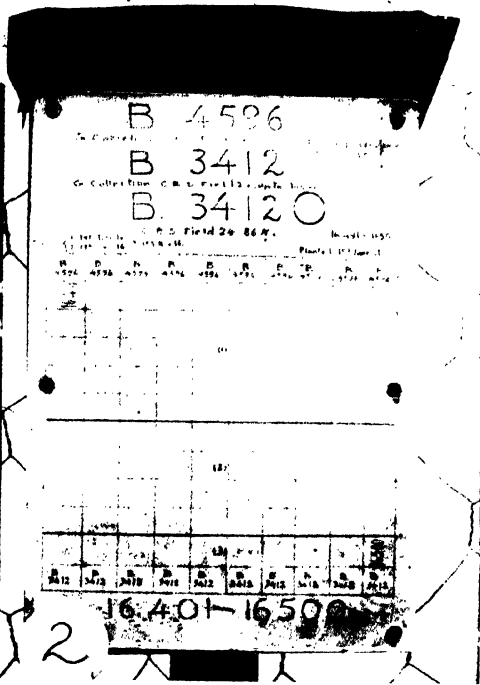
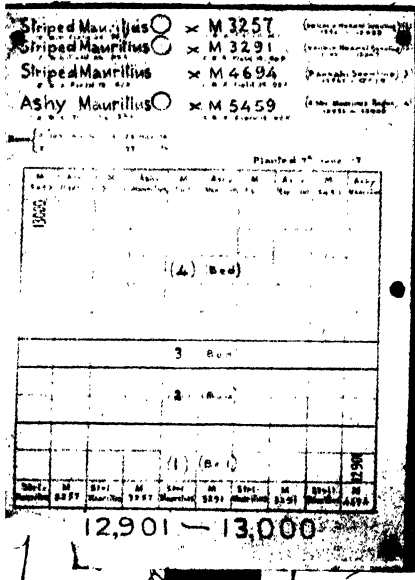
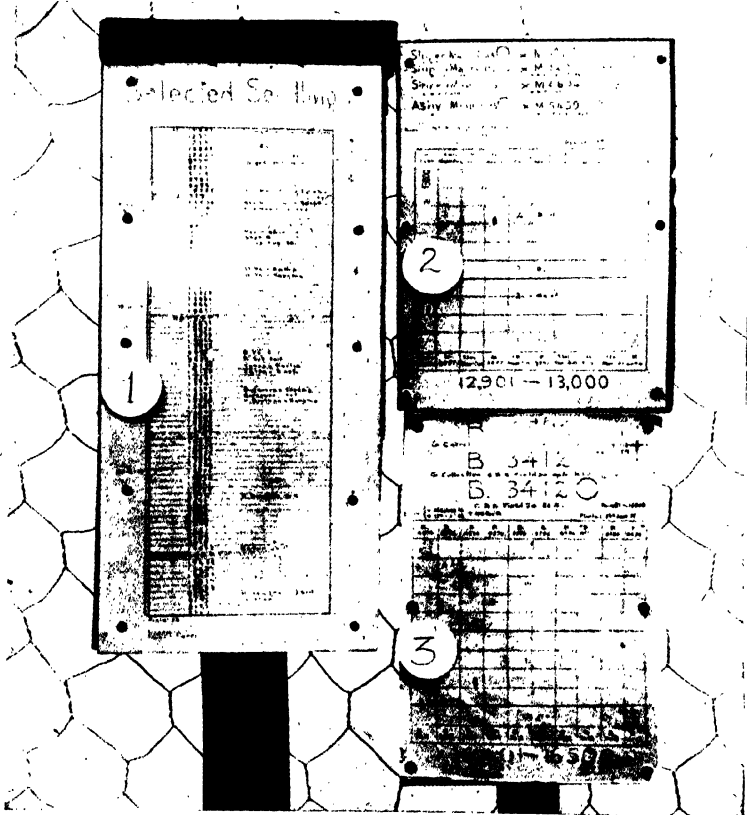

Fig. 1.



Direction of the Water Pipe

It is necessary to determine the direction of the water pipe in the ground. This is done by planting a tree in the ground. The tree should be planted in the direction of the water pipe. The tree should be planted in the direction of the water pipe. The tree should be planted in the direction of the water pipe.

3

Direction of the Water Pipe

The direction of the water pipe in the ground is determined by planting a tree in the ground. The tree should be planted in the direction of the water pipe. The tree should be planted in the direction of the water pipe. The tree should be planted in the direction of the water pipe.

2



Fig. 1.

Stamp planting

This is a method of obtaining a tree quickly by planting a stamp in the ground. The tree should be planted in the direction of the water pipe. The tree should be planted in the direction of the water pipe. The tree should be planted in the direction of the water pipe.

Fig. 2.

EXPLANATION OF PLATE VI.

Nos. 1 and 2 (Fig. 1) illustrate the efficacy of paraffining against the attacks of the silver-fish. Both were hanging against a wall surface for over three years and No. 2 was paraffined. No. 3 (Fig. 1) illustrates the use of paraffined labels for seed-pans which require constant watering.

Fig. 2. is a photographic reproduction of ground-glass labels, the bottom one re-written after 7 years' exposure in the field and the top one as it was after this period.

tacks. Iron tacks are not satisfactory as they soon rust. These labels are not affected by sun or rain and can easily be washed with soap and water if they get soiled with mud or dirt. Occasionally, during close moist weather ring-shaped outgrowths (probably fungus) are seen, but these are easily kept out by occasional cleaning with dilute copper sulphate solution. In the preparation of these labels the cost of paper and paraffin is only nominal and the prices of the labels as already given in the statement hold good for these as well.

Plate VI, fig. 1 (No. 3) shows this form of label as used for seed-pans at the Cane Breeding Station. In the earlier stages of germination sugarcane seedlings require to be watered sometimes as often as six times during the day. The quality of being unaffected by water has made these paraffined labels very useful for the purpose and they are very cheap, costing less than an anna per hundred.

Another use of paraffining is illustrated by Nos. 1 and 2, Fig. 1, Plate VI. The need often arises to hang, against wall surfaces, plans, tables, charts or notices of a permanent nature and in such conditions the silver-fish is very troublesome, frequently eating them so badly as to make them useless for reference. Nos. 1 and 2 have been hanging against a wall, side by side, for over three years, and the effect of paraffining (as shown by No. 2) is very striking.

A very neat and permanent, though rather expensive, form of labelling is illustrated in Plate VI, fig. 2. Glasses are ground and the details written on the ground surface by means of waterproof ink. The glasses are now backed with white paint and slipped into a zinc frame, the front being protected by an extra glass to prevent the rain getting on to the label. Air spaces are provided behind the label glass, and in between the label and the front glass. The bottom picture represents such a label re-written after over seven years and the top one as it was after this period. The front protecting glasses have been removed for purposes of photography. Such labels are very neat, more or less permanent (perhaps requiring just a re-writing once in six or seven years), and their use as permanent labels in botanic gardens and museums is obvious.

With 3½' iron stakes they cost Rs. 2-8 each before the war. The ground glasses need not be purchased as such. Broken panes or washed negatives could easily be ground by rubbing against one another with finely sieved wet sand in between.

Though it first appears simple yet the position of the label in a plot is of some importance. In many of the farms the label is placed in the centre of the variety to which it refers and it is often difficult to say where one variety ends and another begins. At the Cane Breeding Station the label is always fixed at the left hand bottom corner of each plot.

This article is based on experience in labelling gained at the Botanic Gardens, Coimbatore, and the Cane Breeding Station during the last ten years. I am indebted to Dr. C. A. Barber, C.I.E., Government Sugarcane Expert, for help and advice in the course of this work.

THE IMPROVEMENT OF FRUIT PACKING IN INDIA.

BY

ALBERT HOWARD, C.I.E., M.A., AND G. L. C. HOWARD, M.A.,
Imperial Economic Botanist ; Second Imperial Economic Botanist..

WHEN the Quetta Fruit Experiment Station was established in 1911, one of the main items of the programme of investigations was the best means of improving the packing and transport of the fruit produced in Baluchistan. The earlier results were published in 1913 in Bulletin No. 2. A second revised edition was printed in 1915 and during the present year, 1919, a third edition has been called for. In the present paper it is not proposed to repeat the contents of these bulletins but to direct attention to the main results obtained and to refer briefly to certain general principles which have emerged from the work.

Improved fruit boxes were first placed on the market at Quetta in 1912 when the sales reached Rs. 700 in value. The demand rapidly increased during 1913 and 1914 and in 1915 boxes to the value of Rs. 5,000 were sold by the middle of the season, by which time the available stocks had disappeared. During the three succeeding years, 1916-18, the provision of adequate supplies became difficult due to high prices, to the shortage of timber and to the railway restrictions in force throughout India. The work however was continued and the sales reached Rs. 8,000 during the present year (1919) although the stock of the popular non-returnable crates was exhausted early in the season.

In 1919, the Frontier fruit trade laboured under many disadvantages. The war with Afghanistan was in progress and for a time the supply of Kandahar fruit stopped altogether. The

border was disturbed, raids were frequent, and delays on the railways were unavoidable. That the sales of fruit boxes reached the highest point under such adverse circumstances speaks for itself.

Two railway concessions have proved of material advantage in the introduction of modern packing methods among the fruit dealers. In 1916, the Railway Conference Association agreed to our proposals that all parcels, including fruit, should be grouped for purposes of charge and that four types of returnable boxes, recommended by the Fruit Experiment Station, should be returned free from all stations in India to Quetta and Chaman. These concessions are now being very generally utilized and they have greatly stimulated the use of the 24-punnet returnable grape crates and of the cardboard peach boxes.

Seven types of fruit boxes are now on sale at Quetta. For peaches, nectarines, cherries, apricots and plums, three sizes of compartmented cardboard boxes have become popular. For the grape trade, the 2-lb. punnet is the unit adopted. These are set up in crates holding 8, 16 or 24 punnets arranged in tiers separated by lath floors. One of the returnable 24-punnet grape crates is shown in the figure below.

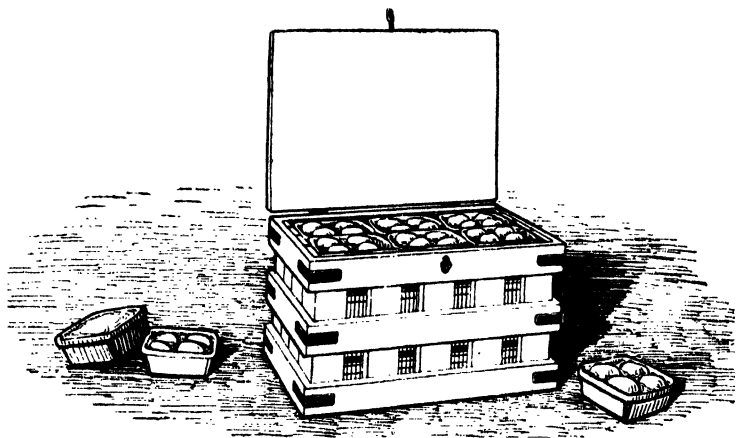

A 24-punnet returnable crate.

About a thousand of these returnable crates were sold during 1919, the retail price being Rs. 5-8 each. This is a high price to

pay for a fruit box considering the fact that the ordinary baskets and boxes in use can be purchased for a few pence. The dealers readily pay cash for these expensive crates and the only difficulty is to assemble sufficient to meet the demand. The advantages of packing the grape crop direct into punnets in the vineyards are now being recognized and the large returnable crates supplied by the Fruit Experiment Station are a common sight on the roads leading to Quetta. Already the larger dealers are considering the question of getting this type of package introduced into the vineyards of Kandahar.

There is no reason why the strongly made standardized returnable fruit package should be confined to Baluchistan. The principle could be easily adopted in the North-West Frontier Province, in Kashmir, in Kulu, Kumaon and in other parts of India. The Railways have shown their willingness to assist, by means of valuable concessions, the efforts made to improve fruit packing in Baluchistan, and there is no reason to suppose that equally effective assistance would not be given to other fruit-growing localities. The non-rigid type of fruit package of the basket type is not adapted for long journeys under Indian conditions and its place should be taken by returnable boxes and crates by which the carrying capacity of the railway vans can be greatly increased and by which the traffic can be more easily handled. By such methods, the product reaches its destination undamaged and therefore commands an enhanced price.

Our experience in removing the disadvantages under which the fruit trade in Baluchistan formerly laboured and in establishing modern methods of fruit packing has brought out two things—the rate at which time-honoured practices and ideas change in India, and the importance of time and patience in implanting a new idea. When in 1911 we commenced these investigations, we were told on all sides that cheapness was the first condition of success in placing new packages on the market. We were constantly reminded that the grape baskets and old kerosine oil boxes then in use were cheap and that they could be purchased for very small sums. When the 24-punnet returnable grape crates were first brought to the notice

of the dealers, they were considered too expensive and altogether unsuited to the conditions of the local trade. A few of the more advanced merchants, however, agreed to try them. The grapes were found to travel perfectly even to places as distant as Madras. A change in the attitude of the trade then began to make its appearance. A demand from the more advanced cities like Bombay that Baluchistan grapes should be packed in punnets followed and from that time success has been assured. The difficulty has been to meet the demand rather than to sell the crates. Nothing is now heard about the cost.

Time is a factor in India in the introduction of new methods, to which insufficient attention is often paid. This is specially important where trade is concerned. Dealers of all kinds have little leisure and practically all their working hours are spent in details connected with purchase, sale and finance. Particularly is this the case with the Frontier fruit dealers whose output of work during the fruit season, considering the means at their disposal, is extraordinary. They have absolutely no time for experiments or for anything else beyond the day's work. To reach such men, patience is essential and they must be given ample time for new ideas to sink into their consciousness.

This experience proves that too much attention can be paid to the first ideas of the people of India towards new methods. They are certain to be frankly sceptical at first and to exhibit that conservatism which is so valuable in protecting the race from disaster. The inventor must therefore be prepared for this and when he is fortunate enough to discover a real improvement and the best thing possible under the circumstances, he should resolutely persist in keeping it before his public year after year.

Selected Articles.

PLANT-BREEDING AND TROPICAL CROPS.*

BY

W. BATESON, M.A., F.R.S.,

Director of the John Innes Horticultural Institution.

KNOWLEDGE of what can be done by scientific plant-breeding in the improvement of varieties is gradually, though very slowly, spreading among those engaged in the raising of vegetable products commercially. In Europe and the United States, work, both experimental and directly economic, is being undertaken on a considerable scale. The most vigorous and extensive of these enterprises are naturally to be found in temperate countries where the prosecution of science is endemic, and of necessity it is to the products of such countries that attention has been chiefly devoted. The crops of these regions, however, have already with one or two exceptions been put through several stages in the process of improvement. Most of them have been in the care of man for long periods of time, their cultivation being indeed one of the earliest signs of incipient civilization. Such plants as wheat, maize and the other cereals, the grape, the olive, and our garden fruits have been so long the subjects of human attention and effort that, though certainly new and better types may still be created, no advance comparable with that which distinguishes them from their nearest wild relatives can be expected. Of the exceptions among these very anciently domesticated plants, flax is by far the most remarkable. Though so long in cultivation that its wild origin is uncertain, its improvement seems to have stopped before history begins. When a plant has no thoroughly distinct and named

* Reprinted from *Production*, Agricultural Number, July 1919.

varieties we may be pretty sure that it has been neglected by the breeder.

Domesticated flax (*Linum usitatissimum*) has been separated into two distinct groups, those for oil and those grown for fibre. There are several forms of oil flaxes, in all probability recently differentiated, but fibre-flax, at least as grown in Europe, though sold under various names according to the place where the seed was raised or whence it was shipped, shows only trifling differences. If any field of flax is examined plants will be found, perhaps one in many thousands, which are about a third as tall again as the ordinary plants. If the flowers of these tall plants are covered to exclude insects, their seeds will be found to give exclusively tall plants like the parents. Flax is commonly a self-fertilizing plant, and all that is necessary to the fixation of such an improved variety is to breed it in conditions of isolation until a bulk of seed sufficient for economic purposes has been raised.

The improvement of a plant is to be achieved only by the deliberate act of man. Each such act is in its degree of the nature of an invention. The ordinary man is content with the type he finds. He is devoid of imagination and unable to free himself from the limitations of conventional practice even to the very moderate extent necessary for the application to a new example of methods long ago developed in other cases. In order to improve the familiar and long cultivated plants two distinct kinds of interference are generally necessary. The new variety has not only to be selected and multiplied but very often it must first be created. This is a much more complicated operation. Laymen still vaguely suppose that improvement is a mere incidental consequence of prolonged cultivation. Almost all novelties, however, are really the result of an act of cross-fertilization between distinct types. The novelties do not usually appear in the offspring *immediately* resulting from the cross, but in the later, derivative generations, sometimes by recombination of elements which the parents respectively introduced; but sometimes, and perhaps more often, a process of disintegration of the elements supervenes, which leads to the production of inter-gradations possessing new properties.

To this disintegrative process, for example, the beautiful series of Sweet Peas, which have been such an astonishing addition to horticulture, is almost wholly due. To carry out these operations and turn them to account is a very intricate business.

The object of this paper is to attract the attention of practical men to the immense field of profitable activity which is open in the improvement of many exotic crops by the simple selection of valuable types already existing.

That this has been so long deferred seems to those accustomed to handle plants truly amazing. The profits to be gained by the fixation of improved varieties are incalculably large. No one plants an orchard by sowing seeds of any tree which can be called a plum or an apple, regardless whether it be a sloe or a Victoria, a crab, a Cox's orange, or a Bramley. Yet thousands of acres of rubber and coconuts are sown in a fashion of which this description is scarcely a caricature. It is to crops of this order, plants which are grown from seed and have only been deliberately cultivated by civilized man for comparatively short periods, that these comments especially apply.

Coconuts and dates are both the fruits of palm trees. Of dates there are scores of named varieties, but coconuts are just coconuts.* What is the reason of this striking difference ?

It is a consequence of the fact that whereas coconuts are all grown from seeds, dates, whenever they are cultivated by intelligent people, are grown from off-shoots. The off-shoots provide a means of vegetative reproduction, so that all the plants raised from the off-shoots of one tree are pieces of one individual and merely replicas of it. In the course of ages many good date-palms with various fine properties have been noticed and multiplied in this way, so that large uniform plantations of them exist. In Mexico, I understand, dates are grown from seed, with the result that the crop has no uniformity, and, consisting of good and bad indifferently mixed, is comparatively worthless. Such a crop cannot compete with the produce of a properly constituted plantation. Coconut

* There are, of course, some local races, very imperfectly differentiated.

palms, like almost all plants, differ enormously, some individuals producing many, others few fruits, and the differences in quality are doubtless equally great. It is true that no one has, I believe, yet succeeded in multiplying the coconut palm by division, but I doubt whether really exhaustive experiments have been made with this object in view. Assuming, however, that the coconut cannot be vegetatively multiplied, and that it must, as heretofore, be raised from seed, the next best course is to make certain that the nuts used for sowing are the produce only of specially selected trees. In the case of coconuts planters are indeed advised to choose nuts from good trees, but they seem to think that they have done all that is requisite when they have selected them from the best *mothers*, no effort or inquiry being directed to the paternity of the seeds chosen. Whether this plant is capable of self-fertilization has probably never been determined. The male and female flowers, though near each other, are separate and it is not unlikely that by the males and females coming to maturity at different times, or by some similar contrivance, a considerable percentage of crossing is effected.

No very serious labour would be needed to ensure that nuts chosen for planting were not merely borne by first-class trees, but the result of pollination either from the same tree, or perhaps preferably from others equally good. To accomplish this would be no very difficult undertaking. It is to be remembered that the plantation is to be cropped for some seventy years. With this long prospect in view it seems scarcely credible that such obvious precautions should be neglected.

If coconut were a European plant we should certainly have varieties differentiated for the production of copra, coir, etc., respectively, but such *finesse* in the circumstances would be premature.

Rubber is another product to which what has been said regarding coconuts conspicuously applies. I am speaking, of course, of rubber as produced by the cultivation in various tropical countries of *Hevea brasiliensis*. One has merely to walk through a rubber plantation to perceive the urgent need for selection. The rubber trees are all raised from seed, just as coconut palms are,

with the same result, that good and bad and indifferent are all grown together. Each takes the same area of the clearing prepared with great labour for the plantation. Each needs the same attention and care, but the output of the several trees is altogether different. In a recent discussion on these subjects at the Royal Society of Arts, I ventured to call attention to the opportunity that was being missed by rubber planters, pointing out that if plantations were planted with only the moderate amount of care which ordinary selective methods demand, the output might be rapidly increased. In reply, the Chairman, a gentleman largely interested in rubber, stated that there was no direct evidence of a great variation in yield amongst different trees, and that in consequence the use of seed was not objectionable. I had in mind, however, not merely verbal reports of persons familiar with rubber-growing, but several precise records giving actual measurements. For example, W. H. Johnson (*Culture and Preparation of Para Rubber*, 1909, p. 27) states that "the yield of rubber from different trees growing under similar conditions in the same plantation varies to an enormous extent." He further quotes experiments of Vernet (*Jour. d' Agric. Tropicale*, 1907) which gave differences ranging between the following extremes: in volume of latex, from 4 to 48; in percentage, *caoutchouc* from 29.28 to 39.74.

R. H. Lock (*Rubber and Rubber Planting*, 1913, p. 74) wrote: "It is well known that rubber trees possess marked individuality as regards the amount of latex which can be drawn from them. Tapping coolies, if left to themselves, soon discover these differences and confine their attention to the best yielding trees..... Among a group of 29 trees of uniform age tapped daily, the highest and lowest average yields for the first 30 tappings were, respectively, 166 and 8 cubic centimetres. The circumference of these two trees was 52 and 32 inches, respectively, and they were not the largest and smallest trees in the group. The yield per inch of bark removed was in the ratio of 317 to 25, or more than 12 to 1." Lock was, of course, not only a sound botanist, but an expert plant-breeder. He urges a rigorous seed-selection in the founding of rubber plantations. Had he lived he would probably

have done much to reform tropical agriculture, infusing the practice of planters with the spirit of accurate knowledge. The rubber tree would indeed be a remarkable exception among cultivated plants grown from seed, which have never been strictly selected and purified, if it did *not* vary enormously. Such variation is almost universal. Plants like our modern cereals and peas which present an approximation to complete uniformity have been reduced to pure strains by the seedsman's art. Each variety of wheat or of peas, though it may now be represented by many millions of plants, descends from a single individual which was deliberately chosen as showing desirable properties. From various causes, impurities occasionally get introduced, and these it is the seedsman's task continually to extirpate. In wheat and peas, which are usually self-fertilizing plants, this process of purification is comparatively simple. But in most plants which are habitually fertilized by pollen from other individuals, borne by insects or by the wind, pure strains are only maintained with great difficulty, elaborate precautions to ensure isolation being part of the regular routine of seed-raising. If it were true that a pure strain of a plant like *Hevea* (which is almost certainly insect-fertilized) has come into existence without the intervention of human agency, the fact would constitute something of a natural curiosity.

In the case of *Hevea* the most obvious course is to multiply good trees by means of cuttings. At Peradeniya the attempt to do this on a large scale failed, only one cutting in 3,000 succeeding, but others have cuttings without special difficulty, and it can scarcely be doubted that after a little experimenting a satisfactory and reliable mode of procedure would be discovered. The plantation which first succeeds in putting this simple suggestion into practice must infallibly outstrip competitors who are content to follow primitive methods. The life of a coconut plantation is, as was said above, reckoned at over seventy years. Rubber planting in the East Indies is an undertaking of such recent origin that no one yet knows how many years the trees will continue to yield rubber in quantity, but certainly the period is a long one, and during the whole life of the plantation the benefit will accumulate.

Though rubber and coconuts are the crops to which these suggestions apply with the greatest force, there are several more which will occur to those acquainted with tropical agriculture. Lock, in the passage quoted above, refers to the extraordinary results obtained by the Dutch in Java by applying methods of seed-selection to *Cinchona*, thereby nearly doubling the yield of alkaloid.

In these cases simple selection of the best types already existing would have incalculable effect. To suggest experimental breeding of these trees with a view to still further improvement may be a counsel of perfection. Not improbably, however, though the reward of that work might be distant, it would eventually be ample. So much work is already set on foot under the auspices of our own and other governments for the development of tropical agriculture that the comparative neglect of these important tree-crops is not easily explicable.

There are other tropical crops which, though liable to much cross-fertilization, must be raised from seed. Of these, cotton is one of the most important. To the improvement of cotton, much highly skilled work has been devoted. Leake in India and Balls in Egypt, not to speak of plant-breeders in America and elsewhere, working on strict genetic lines, had a considerable measure of success in their attempts to raise new varieties of commercial value. Burkill and Firlow have made a beginning with jute, which at present consists of a mixture of most divergent forms. The difficulty is first to work up the seed to a quantity sufficient for economic purposes, and if that were effected, to maintain the new variety pure when distributed among the agricultural population. Seeing that the country will, of necessity, be full of the old unpurified forms hitherto in use, even a small percentage of crossing must soon lead to serious deterioration. The only proper solution is to separate the seed-raising as a distinct industry. To grow the crop may tax the intelligence of the average agriculturist, but to raise good seed is altogether beyond him. Ordinary farming practice in the case of mangels will serve to illustrate what I mean. No farmer thinks of raising the mangel seed which he wants to

sow for his own crop of roots. If he saved a few roots for seed, his neighbours doing the same, nothing but a lot of heterogeneous mongrels would result. Raising mangel seed is an art, and only a trained seedsman can carry it through. I have no doubt that in the future seed of high class cotton, etc., will be specially raised as seed. To do this with accuracy it is not unlikely that special areas will be set apart for seed-raising and some of the smaller islands, for example in the West Indies, might perhaps do well to take up such an industry.*

Provided that cross-fertilization by inferior varieties is excluded, there is no likelihood of deterioration by mere variation. Upon this subject the deepest ignorance still prevails even among professed naturalists. It is common, for instance, to meet the statement that the seeds of cultivated apples give mostly crabs. In the light of modern knowledge, we may feel practically sure, if such a phenomenon really occurs, which is not often, that the "reversion" is not due to the variability of the seed-bearing parent, but to crossing. To such crossing, the pollen of some wild form in uncultivated ground nearby may sometimes contribute. It is, no doubt, conceivable that two cultivated varieties of apples crossed together may produce a crab, but there is no evidence which suggests that this consequence is in the least degree likely, and at any rate we may feel perfectly sure that only by some rare exception could a self-fertilized fine apple produce a crab, or a self-fertilized fine plum produce a sloe or a bullace. Those who are engaged in practical agriculture, and in the administration of agricultural interests, have come to realize that science in the form of plant-pathology and entomology can aid them. Yet in the case of the hitherto "unimproved" crops of the world, the call for the services of the plant-breeder is, I am disposed to think, far more urgent. No improvement in the conditions can convert a poor variety into a good one, a truth which lies at the root not only of agricultural progress but of social reform also.

* Since writing this I hear from Mr. S. C. Harland, of St. Vincent, that a small island, half a mile distant, is there actually used for seed-raising.

THE WORK OF THE ROTHAMSTED EXPERIMENTAL STATION
FROM 1914 TO 1919.*

BY

E. J. RUSSELL, D. Sc., F.R.S.,

Rothamsted Experimental Station, Harpenden, Herts.

THE work of the Rothamsted Experimental Station during the last five years falls into two main groups: problems connected directly with the war, and those connected with the development of agriculture after the war. The war work had the advantage that its significance was obvious, but on the other hand some of it was only of temporary importance, and depreciated considerably in value with the passing of the emergency with which it was intended to deal. The other work has more permanent value; it holds good even after the emergency has passed, but during the war it was sometimes overshadowed by the more pressing and immediate needs of the moment.

WAR WORK AT ROTHAMSTED.

During the first year of the war very little direct war work was done at Rothamsted. Food was still coming into the country in large quantities and there was no great interference with food production at home. Supplies of fertilizers and feeding stuffs were ample. There was, however, fear of unemployment, and three schemes were examined at the request of the Board of Agriculture with the view of ascertaining whether they would usefully employ any considerable number of men, and if so, whether they would contribute to the national profit. These were a proposed development

* Reproduced from *The Journal of the Board of Agriculture*, vol. XXVI, no. 5.

on Foulness Island in Essex, the suggested afforestation of the spoil heaps and pit mounds of the Black Country, and the reclamation of Pagham Harbour in Sussex. None of these schemes was further developed, though two of them—the planting of the spoil heaps in the Black Country and the reclamation of Pagham Harbour—possess aspects of permanent interest. The spoil heaps are useless and unsightly; they can, however, be planted with trees, when they take on a very different appearance, as shown at Reed Park, Walsall. Although the financial returns may not be very great, the improvement in the amenities of the district would be considerable. The proposition is, however, hardly an agricultural one.

The most important war work began in 1916, when the food situation gave cause for much anxiety. The position was really very serious. The submarine menace was looming before us, terrible in its unfamiliarity, conjuring up visions of food shortage, if not of starvation; the only way out of the situation seemed to be the production of our own food in our own country. At the time we were producing only one-half of our total food, and the remainder was coming from abroad. When examined in detail the position was found to be more serious than it looked. The food produced at home included more of the luxuries than of the essentials. It included, for instance, the whole of the highest quality meat; but only one-fifth of the bread. The farmer was, therefore, called upon to perform a double task; he had to produce more food, and different food. He had to give us, not one loaf out of every five that we ate, but three or four out of every five, and to do this without causing too great a shortage of milk, meat, and, if possible, beer. The situation presented many difficult administrative, financial and technical problems. The technical problems involving soils and fertilizers were dealt with at Rothamsted.

The fertilizer problems arose out of the necessity of making the very best use of the limited stocks of the ordinary fertilizers, to which the farmer was accustomed, and of examining any and every substitute that promised help in eking out the supplies. Fortunately, a good deal of information could be drawn from the

Rothamsted and other experiments as to the best way of using fertilizers on particular crops. This was systematized and put in order in a little handbook called "Manuring for Higher Crop Production," issued at a cheap price (1917 : 3s. 6d. net) by the Cambridge University Press so that the farmer could readily obtain it. In addition, a series of notes was issued in "The Journal of the Board of Agriculture" showing how the available supplies might best be utilized.

It was more difficult, however, to give useful information about the substitutes that would be needed if and when the fertilizer supplies became too much reduced. Ordinarily fertilizer tests have to be continued for two or three successive seasons before a definite opinion can be expressed as to their value; during the war, however, some sort of opinion had to be given in three or four weeks. Rapid methods of laboratory testing were therefore developed: growing seedlings were used to indicate whether (as not infrequently happened) toxic substances were present; rates of nitrification in soil were determined to find out how far the substance would yield nutrient material to the plant; farm crops were grown in pots to afford opportunities for testing any material that might seem promising. A considerable number of possible fertilizers were sent in for examination by the Board of Agriculture and Food Production Department, the Ministry of Munitions, the National Salvage Council, and other bodies.

Much of the information was wanted for the purpose of economizing sulphuric acid, so that the maximum quantity might be handed over to the Ministry of Munitions for the manufacture of explosives. In peace time the farmer had been the chief consumer of sulphuric acid; in 1917, however, the Ministry of Munitions were requiring all the acid they could find, and were leaving much less than usual for the fertilizer manufacturers. Even in pre-war days the farmer had required 870,000 tons of chamber acid per annum (equivalent to 580,000 tons of pure acid), and the extra food production programme was calling for even more than this. The Ministry of Munitions were, however, obdurate, and cut down supplies at a rate which seemed to some of the more nervous to

threaten a very serious situation. The production of sulphate of ammonia fell from 350,000 tons per annum to little over 250,000 tons, while that of superphosphate fell from 800,000 tons to 500,000 tons per annum.

Fortunately a substitute for sulphate of ammonia was available in the form of nitre cake, and although no fertilizer manufacturer liked it or had a good word to say for it, it seemed as if it might have to be used extensively in the manufacture of superphosphate and of sulphate of ammonia. Important and difficult technical problems were involved both at the factory and on the farm, necessitating a considerable amount of experimental work. Thanks to the co-operation of the manufacturers, working solutions of the difficulties were found, and there is little doubt that both sulphate of ammonia and superphosphate could have been made from nitre cake had the necessity arisen. Fortunately it did not, and the situation was eased before it became too serious.

A considerable amount of work was also done in the examination of new sources of potassium compounds to take the place of the Stassfurt salts which had previously been our sole source of potassium compounds. A certain number of residues from manufacturing processes were available, but in the main they suffered from one or both of two defects—very low content of potash likely to be useful to the plant, and the presence of toxic substances. After much sorting out of possible materials it appeared that certain blast furnace flue dusts would prove suitable, and accordingly the Food Production Department took steps to make the necessary arrangements for distribution among farmers. Considerable quantities have been used, generally with distinct advantage. With the re-establishment of peace conditions, supplies of potassic fertilizers may be expected from the Continent.

Investigation was also made into the possibility of using to better advantage the farmyard manure produced on the farm, and of using as fertilizer various substances now wasted.

It is estimated by Hall and Voelcker—admittedly good authorities—that some 50 per cent. of the value of farmyard manure is lost on the average farm of the country through avoidable causes.

Thanks to the generous assistance of the Hon. Rupert Guinness, it has been possible to retain an expert chemist, Mr. E. H. Richards, expressly for the purpose of elucidating the causes of the loss, this being necessary before one could hope to find a remedy. The causes of the loss have been traced in an extended series of laboratory investigations, and the conditions necessary for its avoidance have been ascertained.*

Broadly speaking, the conditions to be secured in the making of the manure as ascertained by Dr. Hutchinson are sufficient supplies of nitrogen compounds and of air to allow the cellulose decomposing organisms to effect the decomposition of the straw. For the storing of the manure, however, Mr. Richards' experiments show that it is necessary to have shelter from the rain and also to prevent access of air. The best methods for securing these conditions have required working out for particular cases, which can be done only after consideration of all the local circumstances.

Field experiments have shown that farmyard manure stored in conformity with these conditions is of higher fertilizing value than the ordinary material, the crop being 10 per cent. or more beyond that given by manure kept in the usual way. During the war, when all sources of loss had to be studied and as far as possible stopped, the necessary conditions were vigorously brought to the notice of farmers and Executive Committees by the Food Production Department, and at different times attention has been drawn to the matter in "The Journal of the Board of Agriculture." Savings of several units per cent. on old-established practice are possible, and every one per cent. saved would mean in the aggregate some £200,000 a year at present prices.

A beginning has been made with a much more difficult problem—the handling of manure on a dairy farm. The conditions here are very different from those on an ordinary mixed farm where bullocks are fattened: it is desirable that the dung should be as little in evidence as possible and that the urine should be quickly

* An article on the subject appeared in *The Journal of the Board of Agriculture* for December, 1914, p. 800.

and completely removed from the cow-sheds. So important is this that it must be done even if loss is thereby incurred. Two methods have been studied :—

(1) The removal of the solid excreta and its storage under cover and out of reach of air ; collection of the liquid manure in a tank, and its application to temporary or permanent grass land and on the stubbles prior to taking a root crop.

This method is already in use on certain dairy farms, but careful examination revealed a considerable deficit on the nitrogen account : the liquid only contained about one-half of the nitrogen expected. The loss was traced to the broken straw and solid excreta which always find their way into the liquid and cause an absorption of nitrogen which, though of scientific interest, may prove costly to the farmer, and at any rate deprives the liquid of much of its value.

Further investigation of this absorption is being made ; it may be avoidable, in which case the value of the liquid manure, already high, could be enhanced still further. In case it seems to be unavoidable, however, a second method of procedure is being adopted :—

(2) The solid manure is collected as before, but the liquid is allowed to run through straw under conditions which encourage the absorption of nitrogen compounds. By suitable arrangement the straw increases in fertilizer value, while the liquid loses part of its valuable constituents, and can more easily be sacrificed.

This second method is still in the laboratory stages, but may prove of considerable value. Mr. Richards is carrying out the laboratory experiments at Rothamsted and the large scale experiments at Woking on the Hon. Rupert Guinness' home farm.

THE MAKING OF FARMYARD MANURE WITHOUT ANIMALS.

Two years ago there seemed a prospect of a considerable surplus of straw, and methods of utilization were examined ; in particular the possibility of converting it into a useful manure was studied at Rothamsted.¹ The prolonged drought of this season

¹ *The Journal of the Board of Agriculture*, April, 1919, p. 15.

has dispelled any prospect of excessive straw, but the value of the work remains.

The investigation is being carried out by Dr. Hutchinson and is the logical continuation of work that he has had in hand for some time. Laboratory work has shown that the breaking down of the material of straw, the so-called cellulose, is effected by a remarkable organism which had eluded all previous investigators, but which Dr. Hutchinson succeeded in obtaining in pure culture so that he could study its properties. In order that it may bring about the decomposition of straw it requires two conditions, air and soluble nitrogen compound, as food. If either of these is missing it ceases to act. Moreover, it will only attack cellulose: it is unable to feed on sugar, starch, alcohol or any organic acid yet tried.

Given, however, the necessary nitrogen compounds and a sufficiency of air, the organism quickly decomposes straw, breaking it down to form a black, sticky material, looking very much like farmyard manure. A ton of this material is now being prepared for the purpose of fertilizer tests.

SEWAGE SLUDGE AS MANURE.

Many efforts have been made in the past to utilize sewage sludge, but until recently without success. A new process is now being studied which seems more promising; it gives a sludge containing 6 per cent. or more of nitrogen, in an easily available form. There are, however, a number of problems to be solved before its agricultural value can be established, and work on these is being pressed forward as vigorously as possible. An experimental plant has been erected at the Harpenden Sewage Works, where sufficient material for new tests is being prepared.

The importance of the problem is manifest from the consideration that the total excrements of the inhabitants of the United Kingdom would be worth nearly £18,000,000 per annum as fertilizer if they could be applied to the land. Only a fraction is so used at present, but the need for national economy is such that nothing of value should be wasted.

OTHER AIDS TO PRODUCTION, LIME AND ARTIFICIAL
FERTILIZERS.

Lime. Most farmers know by experience whether or not they require lime, but few use it as regularly as they ought, with the result that clover often fails to do well, and swedes become liable to finger-and-toe. Numerous analyses made at Rothamsted of soils from different parts of the country show how widespread is this lack of lime.

In trying to remedy the deficiency, however, difficulty has arisen because it is not always possible to tell a farmer how much lime the soil needs: often indeed one can only say that he should apply between 10 cwt. and 2 tons per acre. Of course, if farming were independent of costs this vagueness would not matter, but the delicate financial balance under which agriculture has to be conducted leaves no margin for indecision between 10 cwt. and 2 tons. A method has, therefore, been devised by Dr. Hutchinson for estimating the degrees of lime requirement, and when it is known how much lime one part of the land needs, the quantities wanted for the rest are readily ascertained.

Calcium cyanamide. Two new artificial fertilizers have been studied in some detail. Calcium cyanamide, commonly known in this country as nitrolim, is a fertilizer of distinct promise, about which, however, experts still have a good deal to learn.

In field practice it has varied considerably in effectiveness. On the average of all field trials in the United Kingdom, when the effect of nitrate of soda is taken as 100, that of sulphate of ammonia is 97 and of cyanamide 90. The cyanamide results, however, sometimes fall as low as 26 and occasionally rise as high as 238. Mr. Cowie has shown that cyanamide under certain conditions contains another substance, dicyanodiamide, which is poisonous not only to plants but also to the nitrifying organisms. It is less toxic to other organisms, however, and has little effect on the bacteria developing on gelatine plates, the rate and extent of the decomposition of dried blood, or the rate of production of ammonia from cyanamide. In its presence ammonia accumulates in the soil and the normal oxidation to nitrate does not take place.

Dicyanodiamide, therefore, not only injures the plant, but cuts off the supply of nitrate, substituting instead ammonia, which in most cases is less useful, and in some cases directly harmful to the crop. The conditions under which it is formed are known and fortunately can be avoided.

A further investigation is being made into the breaking down of nitrolim in the soil. Nitrolim itself is not a plant food; under suitable conditions, however, it readily changes into such. Usually changes of this sort are brought about by living organisms under conditions which are now well understood. In this particular case, however, something else is involved, the exact nature of which is not yet clear, although Mr. Cowie is on its track. There is little doubt that some of the cases where nitrolim gave disappointing results arose through lack of the decomposing agent, whatever it may be.

Ammonium nitrate. Another investigation arose out of the necessity of making the best possible use of the materials employed in the making of munitions, one of which—ammonium nitrate—had been accumulated in great quantities.

It was known some time ago that at the end of the war large stocks of this ammonium nitrate might be available for agricultural purposes. Experiments were, therefore, made to ascertain its properties as a fertilizer.¹ The material available before the war had been too deliquescent for ordinary use. A much less deliquescent modification is, however, now available; it has been stored for months in the Rothamsted manure shed without giving trouble. Further, it can be drilled with the utmost ease, either alone or mixed with superphosphate (though the mixture should not be stored). It gave good results on mangolds and potatoes and as a top-dressing to cereals. It is highly concentrated, containing 35 per cent. of nitrogen.

Basic slag. Considerable attention has been devoted to basic slag. During the war there has been a great change in the composition of this material in consequence of the extension of the basic

open-hearth process for making steel. The new material contains less phosphate than the old, and less is soluble in citric acid. Field experiments have been made to ascertain its actual value, and inquiries have been made in conjunction with Dr. Stead, of Middlesborough, into the possibility of improving its value.

CONTROL OF SOIL ORGANISMS AND PESTS.

Most farmers have learnt to their cost that soil is inhabited by a number of organisms capable of doing a great deal of mischief ; it is well known that there are others that do very much good. Considerable attention has been devoted at Rothamsted to the soil organisms, and much information has been gathered about them.

The wireworm furnishes a good example of the harmful organisms in the soil. In a general way its life-history has long been known, but little exact knowledge was available before Mr. Roberts began his work at Rothamsted ; in consequence, no sound method of dealing with the pest could be suggested.

Mr. Roberts has, however, succeeded in tracing the precise history of the wireworm from the egg through the larval stage to the beetle, and has brought to light a great deal of new and useful information about it. Further experiments are necessary to discover the best way of using this information. Dr. Malcolm Laurie has carried out some interesting experiments which promise valuable results.

Mr. Tattersfield and Mr. Roberts have also devoted much attention to the effects of poisons on the wireworm. A large number of substances have been systematically tested, and many have been found far more poisonous than the naphthalene sometimes recommended. Ammonia is distinctly harmful to the wireworm—not the sulphate of ammonia used as a fertilizer, but ammonia itself—and it is interesting to note that this is produced in the soil when liquid manure is applied, or when sheep are folded on the land. Either of these methods may be expected to keep down wireworms.

It is hoped that the information obtained in these experiments will enable works chemists to make a satisfactory soil insecticide—

one of the most urgent needs of the arable farmer and market gardener.

Some years ago it was shown at Rothamsted that the treatment of the soil with poisons led to increased productiveness if the poisons could subsequently be removed. The search for a soil insecticide is combined, therefore, with the search for a soil-sterilizing agent, and this part of the work is carried out by Mrs. Matthews, the W. B. Randall Research Assistant, Mr. Randall having generously provided the funds that enable the Station to secure Mrs. Matthews' services. The results are too technical for discussion here, but they show beyond doubt that simplification of the soil population is an advantage to the grower. For the present this information is of direct value only to the nurserymen working under glass. For cucumber- and tomato-growing under glass the most efficient method is to steam the soil, when the undesirable forms are reduced or eliminated, and the useful forms are less affected. Various poisons are now being used successfully, and are, fortunately, much cheaper than heat.

The co-operation of the chemist has led to some interesting developments. It was found in the early stages of the investigation that carbolic acid, which is sometimes phenol and sometimes cresol, was effective in dealing with important pests, but Mrs. Matthews and Mr. Tattersfield have greatly improved on this substance. They find that chlorphenol is about four times as toxic as phenol; di-chlorocresol, which is easily prepared on the large scale, is about five times as effective as cresol, hitherto the most potent agent available for practical purposes.

Some of the so-called poison gases are very effective and if the practical difficulties attending their use could be overcome, they would form a valuable addition to the growers' equipment. This, of course, is work for the future; already, however, the sterilizing methods have considerably increased the output of glasshouse production in the Lea Valley.

A highly useful soil organism, the clover organism, has been studied in some detail and an important advance, made by Mr. Bewley. Before this work was done little had been known of the

way in which this organism lives when it is out of the plant. Mr. Bewley has now shown that it can exist in two forms—one form can move about, while the other cannot. The addition of soluble organic matter causes the latter to change into the motile form.

This fact is of great interest in connection with another result recently obtained at Rothamsted. It was found that clover makes more vigorous growth in a rotation where farmyard manure is used than where artificials only are used.¹ It seems legitimate to suppose that the farmyard manure helps the organism to become motile so that it can easily move about and enter the plant root; this hypothesis is being tested.

Special attention is being devoted to the processes whereby plant food is made in the soil. These processes are of vital importance because on them depends the proper utilization of farmyard manure, clover residues and grass residues ploughed into the land. At present there is good reason to fear that only 50 to 60 per cent. of the potential value of these materials is ever realized: the rest is lost to the farm, and, of course, to the country. Improvements do not come from sensational discoveries; indeed many of the sensational discoveries announced in the press turn out to be nothing but mare's nests. It is the steady advancement of knowledge that helps to solve agricultural problems; link by link the chain is forged until one day, unnoticed and unrecorded, the last link is made and the definite advance is achieved. Practice advances in the same way; a one per cent. improvement here, and a one per cent. improvement there, represents a much more solid achievement than many of the supposed discoveries that sometimes attract so much attention.

WEEDS.

The study of the weeds of the farm is in the capable hands of Dr. W. E. Brenchley, whose results have been published from time to time in "The Journal of the Board of Agriculture" and in the Journals of the Bath and West, and of the Royal Agricultural

Societies ; these results are now being collected, so that it is unnecessary to enter into any detailed account of them here.

PLANT PATHOLOGY.

Farmers suffer great losses every year through the attacks of insects and fungi ; in consequence the Board of Agriculture have recently set up at Rothamsted an Institute for Plant Pathology, the purpose of which is to study plant diseases.

Dr. A. D. Imms is in charge of the entomological work and Mr. W. B. Brierley of the mycological investigations. The primary purpose here, as in the rest of the Station, is to gain information and not to cure particular diseases : indeed it is not too much to say that, until some of the information at present sought is obtained, there will be little hope of cures for many of the ills affecting plants. The treatment of plant diseases is now in somewhat the same position as the treatment of human diseases in the days of the barber surgeons, and further advance can only come when more knowledge is obtained.

THE CANNING OF FRUIT AND VEGETABLES.*

THE preservation of fruit and vegetables by canning has many advantages over bottling, especially when carried out on a commercial scale. The initial outlay is not so heavy, and packing and transport difficulties are much reduced, while breakages of bottles are avoided, and a great saving of time is effected, as large quantities of produce may be dealt with quickly.

Furthermore, if the canning be carefully done the flavour of canned fruit is considered superior to that of fruit preserved by other methods. This is due to the fact that the cans are hermetically sealed before being sterilized, and all volatile oils and flavours are, therefore, retained.

APPARATUS NECESSARY FOR CANNING.

The apparatus necessary for canning by the "water-bath method" depends a great deal upon the quantity of fruit to be dealt with. For ordinary household purposes a large pan fitted with a false bottom can be used, or special sterilizing pans holding 18-20 3-lb. cans may be purchased. When using these pans the cans must be submerged in boiling water. If desired, an ordinary copper can be used; in this case it is advisable to obtain the special tin trays with handles which fit into the copper, so that the cans are easily lifted in and out.

Complete outfits of canning apparatus may be bought, and attention may be drawn to the following types:—

* Reproduced from the *Journal of the Board of Agriculture*, vol. XXVI, no. 5.

The Royal Home Canner (Fig. 1.) is suitable for domestic purposes and is so constructed as to generate steam quickly. This apparatus will hold three dozen 3-lb. cans at one time. It is portable, and wood, coal or gas may be used to generate the steam.

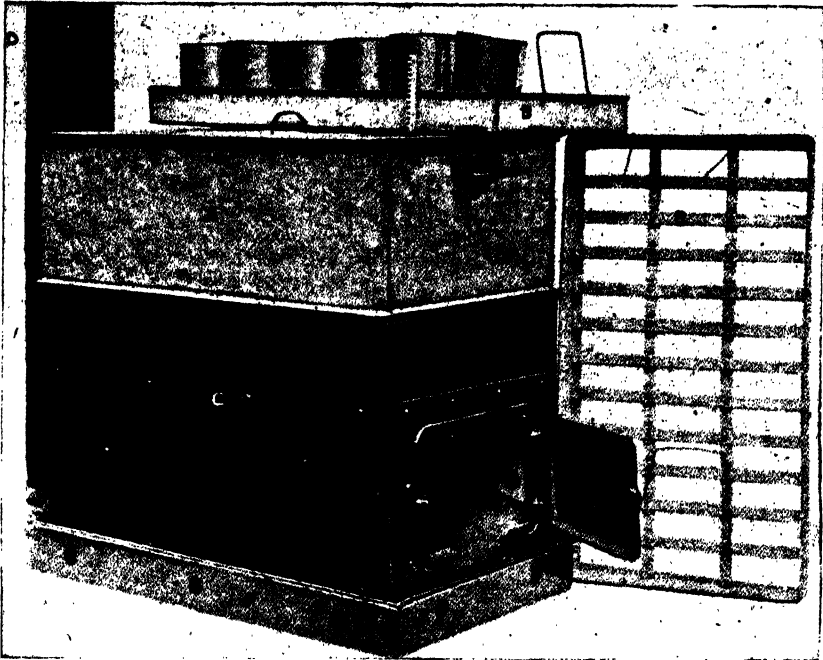

FIG. 1. *The Royal Home Canner*, showing the following parts:—A, covered boiler or sterilizer made of galvanized iron and fitted with handles; B, tray to hold cans; C, japanned iron carrier lined with asbestos; D, chimney to carry off smoke when wood or coal is used as fuel; E, grate for wood fuel, etc.; F, loose tray in which the canner stands.

The Pressure Canner is a more complicated apparatus than the *Royal Home Canner*. It generates and retains steam under pressures varying from 5–30 lb. per square inch, and must be fitted with a pressure gauge and safety valve. It enables canning to be carried out very rapidly, and is the only sure method of canning meat, fish, and such vegetables as peas and beans, but is not essential for fruit or tomatoes.

Full particulars of large commercial or pressure canning outfits may be obtained through the trade journals.

PRESERVATION OF FOOD BY STERILIZATION.

It is a well-known fact that food decay is caused by germs present in the air. These germs are of three classes, two of which, yeasts and moulds, attack both fruit and vegetables, and a third, bacteria, attacks vegetables only.

The destruction of these organisms by heat is known as "sterilization." If this is properly carried out and reinfection is prevented, food is preserved for an indefinite period.

A temperature of 150° F. to 190° F. is sufficient to kill yeasts and moulds, but bacteria are not destroyed except at a temperature of 212° F. (boiling point). In each case the temperature must be maintained for the proper length of time.

EQUIPMENT REQUIRED FOR CANNING (PLATE VII).

Successful canning can only be accomplished if all the equipment is ready to hand before starting. The following are essential :—

1. *Sterilizer.* This may consist of any large pan or, better still, a specially made canner.
2. *Cans and lids.* The cans are made of tin in nominal 1, 2, 3 and 7-lb. sizes. A reputed 2-lb. can will hold 2 lb. of pulp or jam, but only 1½ lb. of fruit in water; the other sizes are in proportion. Each lid should have a small vent-hole, and cans with wide mouths are the most suitable.
3. *Solder.* This is used for soldering on the lid and sealing the vent-hole.
4. *Flux and small brush.* Flux or soldering fluid is used for cleansing the tin to ensure that the solder adheres.
5. *Soldering irons.* These have copper ends and must be kept smooth and bright.
6. *File and Emery paper.* Necessary to clean the irons.
7. *Clean cloths.* For wiping the cans, etc.
8. *Boiling water.* In plentiful supply.



EQUIPMENT FOR CANNING.

A, soldering iron heater; B, stick of solder; C, cans with caps and funnel for filling purposes; D, kettle to ensure a supply of boiling water; E, can tongs for carrying hot cans; F, jar of flux; G, small basin and brush for using flux; H, file; I, knife for preparing the fruit; J, thermometer; K, soldering irons.

PREPARATION OF FRUIT AND VEGETABLES.

• *Grading.* Vegetables and fruit must be graded carefully according to colour, size and ripeness. This ensures the best "pack" and uniformity of flavour and texture to the canned product: these points are very important and should always be kept in mind.

Blanching. Prior to canning it is very necessary for all vegetables and many kinds of fruits to be "blanched." Thorough cleansing and the removal of acid and acrid flavours are thereby ensured, and the colouring matter sets; the bulk of green vegetables is also reduced, and the splitting and cracking of cherries, damsons and plums are prevented. Peaches and pears are rendered more transparent and given a better texture and more mellow flavour. Soft fruits do not require "blanching."

The operation consists of plunging the vegetables or fruit into boiling water for a time, which may vary from 1 to 15 minutes according to the state of maturity and the kind of fruit and vegetables used.* After the necessary time has elapsed, the fruit or vegetables should be removed from the boiling water and plunged immediately into cold water two or three times, but they should not be left in the cold water to soak. The plunging into cold water sets the colouring matter, and is termed "cold-dipping." Vegetables are made more crisp if salt is added to the cold water.

Vegetables	Time of blanching
Peas and beans	2-3 minutes.
Carrots (according to size and age)	5-15 ..
Celery (according to thickness)	3-5 ..
Beets	5-10 ..
Tomatoes	5-10 .. to loosen the skin.

* A wire basket or piece of cheese cloth is useful for this purpose.

FILLING AND SOLDERING THE CANS.

Packing the cans. Wash the cans in *boiling* water immediately before filling. Take one can at a time and pack with fruit or vegetables to within $\frac{1}{2}$ in. of the top, but without crushing. To ensure a good "pack" the cans should be *weighed*, particularly if the product is for market purposes. Cans after being packed should be dealt with as quickly as possible and not allowed to stand about open.

Adding water, syrup or brine. Immediately after packing sufficient liquid must be added to cover the produce. Fruit may be canned in either water or syrup, but the latter is to be preferred as it imparts a better flavour to the canned product. For vegetables brine should be used. The syrup, brine or water used for filling the cans should be boiling (*see* page 83 for strengths). Next place the lid on the can and wipe dry with a clean cloth.

Soldering on the lid or capping. Apply a little flux with a small soft brush around the groove of the cap, taking care that none enters the can. With the hot iron, well tinned, in the right hand and the solder in the left hand, melt two or three drops of solder round the cap in the groove (Fig. 2). Steady the cap with the stick of solder, but do not cover the vent-hole. Then draw the melted solder round the cap in an even, smooth stream with the hot iron.



FIG. 2. Soldering a can, showing correct position of hands, the soldering iron held in the right hand and stick of solder in the left. A small portion of solder has been dropped on the rim of the cap, and is being drawn round by the hot soldering iron. The stick of solder, meanwhile, holds the cap in position.

Sealing the vent-hole or tipping. If boiling water has been used in filling the cans, then tipping may be done immediately after the lid is soldered on, as enough *air will have been exhausted* or driven out through the vent-hole. To tip a can, place the point of the hot iron over the vent-hole and touch the iron slightly with the

solder stick. A bead of solder will then drop on to the vent-hole and make a neat tip. The description of the contents must then be marked on the can with an oil crayon.

EXHAUSTION.

The operation of "exhaustion" or driving out the air from the cans before "tipping" is very important. By using boiling liquid to fill the cans, and "capping" them immediately, the centre of each can will register from 170° to 190°F., and sufficient exhaustion then takes place. No can should be tipped below a temperature of 170°F.

When "tipping" is not done immediately after "capping" and the interior temperature of the can has fallen below 170° F. the air should be exhausted by placing the cans, with the vent-holes open, in the canner for 5 to 15 minutes until the temperature is brought up again to 170°-190° F. The cans are then removed from the canner and immediately dried and tipped. Great care must be taken if this method is adopted, for by over-exhaustion the cans collapse (Fig. 3 C) on cooling and the contents, although properly sterilized, become mushy.

Sterilization. This is the term applied to the process of heating the cans to ensure the destruction of the organisms responsible for decay. The time allowed for sterilizing must be reckoned from the moment the water *boils after* the cans have been lowered into the canner. For sterilizing in steam, a thermometer is absolutely essential.



FIG. 3. Comparison of perfect and imperfect cans. A, perfect can; B1, bulged can, showing how the top and the bottom of the can has bulged owing to fermentation caused by insufficient sterilization; B2, burst can, caused by insufficient sterilization and weak joints in the can—although bursts from the latter cause very seldom occur; C, collapsed can, due to insufficient filling and over-exhaustion.

Time table.

Products to be canned	Preparation	Time of sterilizing
<i>Soft fruit.</i> Gooseberries, Currants, Strawberries, Raspberries, Loganberries.	Graded	15-20 mins. at 212° F. (according to ripeness).
<i>Stone fruit.</i> Cherries, Plums, Damsons, Apricots and Peaches.	Blanched and cold dipped.	15-20 mins. at 212° F. (according to ripeness).
<i>Hard fruit.</i> Apples and Pears ...	Peeled, cored and blanched and cold dipped.	20-30 mins. at 212° F. (according to ripeness).
Tomatoes	Scalded and peeled ...	20-30 mins. at 212° F.
Vegetables	Blanched and cold dipped.	2 hours. Green vegetables to be redone after 48 hours.

NOTE.—Very ripe fruit always requires more sterilizing than unripe fruit.

Cooling the cans. All tinned products must be cooled as quickly as possible to check subsequent cooking, which would otherwise continue for some time, and so spoil the colour and reduce the fruit to pulp. To cool the cans plunge them into a bath of cold water, or, if large numbers are being dealt with, spray them with a hose pipe. The cans must not on any account be piled up one on top of the other until thoroughly cold. Before storing, the cans should be first dried to prevent rusting, and then lacquered and labelled.

TINNING OR PREPARATION OF IRONS FOR SOLDERING.

See that the irons are bright and smooth, and heat thoroughly in a clear fire or over the gas. Place some soldering fluid (flux) in a stone jar for cleaning the irons, and also a small quantity in a clean glass jar for brushing the tins. Dip the irons into the jar of flux and rub the ends with the stick of solder, then immediately dip again into the flux and the solder will be found to run evenly over the iron. This "tinning" is most important, for if the irons are not kept clean and well tinned, the soldering of the cans cannot be carried out successfully. So long as the irons are not made *red hot* they will remain "tinned" and need only be dipped into the flux before using. When once the operator becomes accustomed to the handling of the tools, the soldering may be done very quickly.

and perfectly. A pound of solder will seal a gross of cans, and an efficient operator can do sixty cans an hour.

BRINE AND SYRUP.

Brine or syrup is made by boiling the correct amounts of salt or sugar in water for ten minutes. All impurities are then skimmed off the top.

For brine, one tablespoonful of salt is required for each quart of water.

The strength of syrup will vary according to the class of fruit to be canned.

- | | |
|---|--|
| 1. Soft Fruit, Plums and Cherries .. Thin | 2½ lb. sugar to each gal. of water. |
| 2. Pears Medium | 4½ lb. sugar to each gal. of water. |
| 3. Peaches and Apricots .. Heavy | 6½ to 8 lb. sugar to each gal. of water. |

Strawberries and raspberries should be canned in syrup made from the juice of the berries, in which case no water or syrup is used.

CAUSES OF FAILURE IN CANNING.

1. *The use of unfit material.* Fruit and vegetables for canning must be perfectly fresh and in good condition, and must be canned as soon as possible after gathering. Failures known as "Flat Sours" are caused by using material which has fermented or heated through standing for some time. Fruit gathered wet and kept together in too large quantities, or peas remaining in closed baskets or bags are very liable to be spoiled in this manner. The contents of the cans are sour, although there is nothing to indicate this condition until they are opened.

2. *Insufficient sterilization.* Swollen or bulged cans (Fig. 3 B) are usually caused by the produce fermenting through insufficient sterilization. The ends of the cans become distended with the gas which is generated. The contents are unfit for consumption and have an offensive odour.

3. *Careless sealing.* This causes cans to leak and results in the contents going bad. Great care must be taken to detect any leaks before storing, and if found they must be repaired at once. Cans should be tested *after soldering* by lowering each one into a bath of hot water. If a leak is present bubbles will rise to the surface of the water.

4. *Overpacking or sealing when too cold.* This also causes bulged cans. If due to overpacking, the cans can be made to resume their normal shape on cooling by pressing in the ends. The contents of the bulged cans due to these causes are quite wholesome.

5. *Shrinkage of produce in the cans during sterilization.* This may be caused by—

1. Improper blanching and cold dipping.
2. Loose packing through careless grading.
3. Sterilizing too long.

6. *Cloudy peas* are caused by—

1. Using peas with cracked skins.
2. Blanching too long.
3. Using hard water.

7. *Discoloration of fruit* is due to—

1. Careless blanching.
2. Continued cooking due to piling the cans on top of others before they are cool.
3. Using over-ripe fruit.

NOTE.—*Rhubarb* should never be canned unless a very heavy syrup is used. Otherwise the lacquer of the cans will not withstand the excessive acidity of the rhubarb and the inside of the tins will rust. The contents of cans in this condition are unfit for consumption.

Notes

A SUSPECTED CASE OF POISONING FROM LINSEED CAKE.

THE occurrence of a considerable proportion of cyanogenetic glucoside in linseed cake is well known, and is of considerable interest in view of the fact that this cake is generally considered to be one of the safest cattle foods. Ingle¹ refers to this subject as follows:—"A point of some interest is the, almost universal occurrence of a cyanogenetic glucoside, Linamarin, identical with phaseolunatin, in linseed cake. Fortunately the hydrolysing enzyme, capable of liberating hydrocyanic acid from this substance, which is present in the seed, is destroyed by the high temperature employed during the extraction of the oil, so that the cake is rarely, if ever, poisonous from this cause."

The probability that the feeding of linseed cake may occasionally become dangerous has been the subject of several investigations. G. D. Lander² carried out feeding tests on sheep with a linseed cake containing 0.025 per cent. HCN, giving a ration of from 1 to 5 lb. of moist cake per diem, and obtained no definite result. The same observer also fed rations containing HCN in the form of potassium cyanide and only obtained definite results when 30 grains of HCN were administered. He concludes that linseed cake, such as is usually employed, is harmless.

Collins³ studied the rate of evolution of hydrocyanic acid from linseed cake under digestive conditions, and found that the amount of HCN produced depended upon the amount of enzyme

¹ "Text Book of Agricultural Chemistry," Chapter XIV, p. 282.

² Lander, G. D. *Jour. Bd. Agri.*, XVII (1911), 11, pp. 904-907.

³ Collins, S. H. *Proc. Univ. Durham Phil. Soc.*, IV (1911-1912), 3, pp. 99-106.

present, and the temperature and the degree of acidity of the liquid, and concluded that, in normal health, the acidity of the stomach is too high for the production of HCN from linseed cake, but abnormal conditions may cause its production.

Auld¹ found that the majority of linseed cakes examined by him produced prussic acid on maceration with water, the amount varying from 0.001–0.052 per cent. In only a few cases was no prussic acid found owing to the enzyme having been destroyed. The total HCN content of the cakes examined varied from 0.023 per cent. to 0.056 per cent., the average being 0.036 per cent. He found that the formation of HCN at blood heat was exceedingly rapid—half the available HCN being often liberated in fifteen minutes—the maximum being attained in six hours. The hydrolysing enzyme is, however, easily destroyed by mixing the ground cake with boiling water, and the gruel, when properly prepared, is practically harmless.

In view of the generally expressed opinion that linseed cake as usually employed does not give rise to deleterious effects, it is worthwhile drawing attention to a suspected case of poisoning which has recently passed through my hands. Several cases of suspected poisoning of horses having occurred at the Saharanpur Remount Depot, samples of the materials forming the ration were submitted for examination. Of these, suspicion attached to the linseed cake which was found to contain 0.023 per cent. HCN and a recommendation was made that the use of this foodstuff should cease. This was done and a report was subsequently received stating that no further cases of poisoning had occurred, and it would therefore seem very probable that this cake was the cause of the trouble.

The linseed cake in question had every appearance of being the local production of the country oil mill in which the temperature of extraction is comparatively low and consequently the hydrolysing enzyme was not destroyed, thus leading to the liberation of an excessive amount of HCN during digestion. In view

¹ Auld, S. T. M. *Jour. Southeast Agri. Col. Wye*, 1911, no. 20, pp. 289–326.

of these facts, it would therefore be advisable, when using country cake, to take such measures as will lead to the destruction of the enzyme before feeding to cattle. [W. H. HARRISON.]

*
* *
*

INDIAN SUGAR COMMITTEE.

THE Government of India, in the Revenue and Agriculture Department, issued the following Resolution on the 2nd October, 1919 :—

“ Among the many questions which have been brought into prominence by the war, that of the possibility of organizing and developing the sugar industry in India stands high in importance. It is not a new question. It has been considered by the Board of Agriculture in India from time to time, and formed one of the main subjects of discussion at its last meeting at Poona in December 1917, when the necessity for a bureau of information on the industry was emphasized. A beginning in this direction has already been made ; and Mr. Wynne Sayer of the Indian Agricultural Service was in February last placed on special duty to undertake the collection and co-ordination of all available information regarding the industry. But this is only a beginning and the Government of India realize that much remains to be done if any material expansion of the industry is to be looked for.

“ 2. Regarding the desirability of such expansion there can be no doubt. The food value of sugar is high : the annual consumption has been increasing steadily for many years, and in India no less than elsewhere. Sugarcane is indigenous in India which until very recent years stood first of all countries in the world in its area under cane and its estimated yield of cane-sugar, and even now ranks second only to Cuba. Yet it is notorious that the yield both of cane and raw sugar per acre and the percentage of available sugar extracted from the cane are undesirably low. While, therefore, India should be in a position, as she was in the past, to produce a surplus of sugar for export, she has in fact had to supplement her own supplies by imports the tendency of which steadily to increase

has only been checked by war conditions. The same conditions have also served to emphasize the disadvantages involved in relying upon external sources of supply. The world prices of sugar have risen enormously, with the result that, while imports between 1913-14 and 1917-18 fell in quantity from 900,000 to 500,000 tons approximately, they rose slightly in value from 14·96 to 15·32 crores. The beet-sugar industry has been disorganized over extensive areas in Europe and, if India cannot now look to herself to supply her own wants, she is faced with the alternative of either reducing her consumption of sugar, or paying increased amounts to obtain it.

“ 3. But if the desirability of extending the sugar industry in this country is obvious, the difficulties involved are hardly less so. Apart from the difficulties attending the cultivation and manufacture of cane-sugar in all countries, the Indian industry is confronted with problems which are either peculiar to India or exist there in a special degree. The systems of land tenure exhibit great variety and are complicated by the customary laws of inheritance and joint ownership. Again, the bulk of the sugar produced in India is consumed in its crude state as *gur* or *jaggery*; and this fact has an essential bearing on the prospects of a successful venture for the production of factory sugar in any particular locality. There are indications that the incentive of present prices of sugar is attracting considerable attention to India as a further source of supply; and that the necessary capital and business enterprise would be forthcoming if the whole question both in its agricultural and manufacturing aspects were thoroughly investigated, and the conditions essential to the establishment of an organized industry authoritatively defined. The Government of India are, therefore, of opinion that the time is opportune for the appointment of a representative Committee to investigate the problem in all its bearings and to advise whether a definite and co-ordinated line of policy can be laid down for the promotion of further development. They have accordingly, with the approval of His Majesty's Secretary of State, decided to appoint a Committee for this purpose during the coming cold weather, under the presidency of Mr. J. Mackenna, C.I.E.,

I.C.S., Agricultural Adviser to the Government of India, and with the following terms of reference :—

1. to examine the various sugarcane growing tracts of India with a view to determining the nature of the expansion possible in such tracts either by the development of a factory industry or by improvements in the existing indigenous methods ;
2. to examine the possibility of consolidating the areas under cane and of the extent to which this is limited by the existing systems of land tenure ;
3. to report on the work already done by the Sugar Expert with regard to the breeding and selection of improved varieties of cane, and to make suggestions as to the extent and direction in which this work can be further expanded ;
4. to examine the present methods of co-ordinating work on sugarcane adopted by the Agricultural Departments working in the various provinces and the efficiency of agricultural practice in vogue in India or recommended by the Agricultural Department ;
5. to examine the existing sugar factory industry in India and to advise in what localities and under what conditions a factory industry can be successfully established ;
6. to examine the economic and labour conditions now prevalent in the various districts where expansion of the sugar industry is likely and the question of improving railway facilities and other means of transport which may be required with a view to furthering the spread of the industry ;
7. to investigate the work that is being done in the introduction of improved small power plants and small power factories ;
8. to review the position of India with regard to the world's sugar supply and to formulate recommendations for the improvement of that position ;

9. to investigate the conditions under which refined and raw sugar and molasses are imported into India ;
10. to examine the effects of controlling such imports by a duty, and, where necessary, grading this duty so as to give preference to sugar grown in British dependencies ; and
11. to examine the present conditions governing the manufacture of rum under license from Government and the question of distributing such Government contracts.

The Committee is expected to assemble on October 26th. It will tour to such extent as may be necessary for the local examination of existing conditions, and it will examine witnesses with a view to the thorough consideration of all shades of informed opinion. The Government of India trust that Local Governments and Administrations and their officers will afford the Committee all facilities for the furtherance of its investigations, and will comply with any requests for information or advice which it may address to them.

“ 4. The Government of India are not yet in a position to announce the names of all those who will serve as members of the Committee ; but its composition and personnel, in so far as these have already been decided, will be as follows :—

1. Mr. J. Mackenna, C.I.E., I.C.S., Agricultural Adviser to the Government of India, *President*.
2. A member of the Indian Civil Service as Vice-President (to be nominated later).
3. The Hon'ble Mr. Lalubhai Samaldas, C.I.E., Bombay.
4. Sir Frank Carter, Kt., C.I.E., C.B.E., of Messrs. Turner, Morrison and Company, Calcutta.
5. Sirdar Jogendra Singh, Punjab.
6. Mr. J. W. Macdonald, of Messrs. Henry Tate and Sons, Ltd., Sugar Refiners.
7. } Two other experts to be obtained from England (will be
8. } announced later).
9. Mr. Wynne Sayer of the Indian Agricultural Service.

In addition to the above the Committee will co-opt Mr. A. B. Shakespear, C.I.E., of Messrs. Begg Sutherland and Company,

Cawnpore, as a member for the period of its tour in the United Provinces, and it is proposed similarly to co-opt a representative of the industry in Southern India. Mr. A. E. Gilliat, I.C.S., will act as Secretary to the Committee.”

Since the issue of this resolution the Government of India have appointed Mr. F. Noyce, I.C.S., as Vice-President, and Mr. B. J. Padshah, M.A., of Messrs. Tata, Sons and Company, as a member of the Committee in place of the Hon'ble Mr. Lalubhai Samaldas who was unable to accept the invitation, and have obtained the services of Mr. W. Craib, a planter with experience of Demerara and Cuba, as a member of it.

The Committee toured from the 26th October to the end of December, 1919, in the United Provinces, Bihar, the North-West Frontier Province and the Punjab.

From January to April 1920, the Committee will tour in Assam, Bengal, Burma, Madras, Deccan Hyderabad, and Bombay. The Central Provinces and Gwalior will also be visited, but this may not be done till after the 1920 monsoon arrives.

* * *

COLLOIDS AND CHEMICAL INDUSTRY.*

ANYONE familiar, even in the least degree, with the general nature of chemical industry, and the applications of chemical science to other sciences, cannot but be impressed with the importance which colloid chemistry has attained within recent years in these two directions. In order that the significance of this branch of chemistry, hitherto very largely neglected, particularly in its scientific aspect, may be more fully appreciated and recognized, a committee of the British Association was formed in 1917 to consider the problem.

Last year (*Nature*, March 28, 1918) attention was directed to the publication of the first report of this committee. The object

* Second Report of the British Association Committee on Colloid Chemistry and its General and Industrial Applications (1918). (Published for the Department of Scientific and Industrial Research by H. M. Stationery Office, 1919.) Price 1s. 6d. net.

which the committee has in view is to prepare in the form of sectional reports a summary of information respecting the present position of colloid chemistry and its various applications to other sciences, and especially to chemical industry. Each section is written by an authority on the subject treated. The first report dealt with the following technical subjects:—Tanning, dyeing, fermentation industries, rubber, starch, gums, albumin, gelatin, gluten, cements, nitro-cellulose explosives, and celluloid.

The committee has now issued its second report, which appears under the *ægis* of the Department of Scientific and Industrial Research. It may be obtained from H. M. Stationery Office or through any bookseller. The general arrangement adopted in the first report is adhered to in the present one. This consists of (1) classification according to the scientific colloid subject, and (2) classification according to the industrial process and general application of colloid science to other sciences. Under the first head the subjects treated are:—(i) Peptization and precipitation (W. D. Bancroft); (ii) emulsions (E. Hatschek); (iii) the Liesegang phenomenon (E. Hatschek); and (iv) electrical endosmose (T. R. Briggs). Under the second head are:—(i) Technical applications of electrical endosmose (T. R. Briggs); (ii) colloid chemistry in the textile industries (W. Harrison); (iii) colloids in agriculture (E. J. Russell); (iv) sewage purification (E. Arden); (v) dairy chemistry (W. Clayton); (vi) colloid chemistry in physiology (W. M. Bayliss); and (vii) administration of colloids in disease (A. B. Searle).

It is only right to point out that the compilation of these sections represents a gratuitous contribution on the part of the compilers for the general benefit of all who may be engaged in pure or applied science or in industrial operations in which colloids play a part.

It is obvious, from the mere enumeration of the subject-headings, that a very valuable amount of material has been collected which, it is hoped, will serve the purpose of emphasizing the fundamental importance of colloid chemistry for operations and processes which, at first sight, might appear to be wholly distinct.

A number of sections remain to be dealt with, and it is hoped that these will be included in the third report which is now in preparation. [W. C. McC. LEWIS in *Nature*, dated 7th August, 1919.]

*
* *

REMOVAL OF RESIDUAL FIBRES FROM COTTON-SEED AND THEIR USES.

MR. ED. C. DE SEGUNDO, in the course of a lecture delivered at the British Scientific Products Exhibition on July 23rd, 1919, said :—

After the fibres of spinnable length have been removed from the seed-cotton by the action of the gin, and a further quantity recovered by saw-linting devices, it is found that upon about 95 per cent. of the cotton-seed produced, an appreciable quantity of cotton fibre still remains adherent to the seed. These short fibres have long been known to be suitable for many industrial purposes if only they could be recovered in a sufficiently clean condition at a sufficiently low cost. The difficulties in the way of accomplishing this mechanically on a commercial scale appeared to be insuperable for a number of years, and it is stated that hundreds of thousands of pounds were spent in fruitless attempts on both sides of the Atlantic. Such fibres were looked upon as a waste product until about seven years ago, when I was fortunate enough to work out a machine which successfully separated them cut from the decorticated hulls of the cotton-seed produced under the American system of manufacturing cotton-seed oil. These machines have been at work in the United States commercially since the autumn of 1913, and a good many thousand tons of such fibre in the form of explosives were used by the Allies during the war. About five years ago I was led to attempt the solution of a somewhat similar problem involved in removing these residual fibres direct from the cotton-seed, and the machine which I shall have the pleasure of showing you in action at the conclusion of this lecture is the result of these efforts. This machine removes from the woolly varieties of cotton-seed such of the residual fibres as are not recoverable efficiently or economically by saw-linting or other

existing devices, and delivers them in a form so free from the dirt and debris always present in the cotton-seed of commerce, that the highest grades of paper, artificial silk, vulcanized fibre and other commodities can be manufactured from the product of this machine which is termed "seed-lint" to distinguish it from the "hull-fibre" recovered by the other machine to which I referred above. Upwards of 10,000 tons of the residual fibres obtained by my machines in the United States from the hulls of cotton-seed have now been used in Great Britain, in France, and in the United States, for the manufacture of high-grade papers, of explosives, and of vulcanized fibre. "Seed-lint" is, of course, identical in its characteristics with "hull-fibre" but is superior in quality, being exactly the same material but removed from the seed *before* decortication. "Seed-lint" has been exhaustively investigated by the well-known firm of Cross and Bevan, Analytical Chemists, of London, who pronounce it to be "a new and superior product which, as regards chemical composition, approximates to that of raw long cotton. Messrs. Cross and Bevan also draw attention to the fact that "seed-lint" fulfils the most exacting requirements for the production of cellulose acetate. Courtaulds, Limited, the well-known makers of artificial silk, have tested seed-lint for their special purposes, and have found it entirely suitable. Last year the Ministry of Munitions of War investigated the properties of seed-lint, and reported that they found it suitable for the manufacture of nitro-cellulose powders.

Apart from the industrial value of these residual cotton fibres the removal thereof from the seed concomitantly results in a considerable improvement in the seed for the purposes of the production of oil and feeding-cake and in a corresponding increase in the market value of the seed, a fact that has recently been confirmed by the investigations of the engineer and manager of an important seed-crushing mill in England. His figures show that, *on the basis of pre-war trading conditions*, the seed-crusher should realize an added advantage of as much as £2 10s. per ton by treating certain varieties of cotton-seed in this machine prior to crushing, as compared with the results obtained in his ordinary practice. Upon the basis of

prices ruling to-day, the advantage would be much greater. This gentleman further points out *that even if the value of the residual fibres obtained be entirely neglected*, there still remains substantial additional profit to the seed crusher. To go into technical details concerning this machine would take us too far afield, and I must confine myself to such aspects of the subject as are likely to interest you from a general point of view. [*Journal of the Royal Society of Arts*, Vol. LXVII, No. 3480; August 1, 1919.]

* * *

MANIPULATION OF SHORT-FIBRED COTTON.

AN interesting lecture on the above subject illustrated by diagrams and photographs of lay-outs and machinery, samples of priced Indian and Chinese cottons, various soft wastes and yarns, also blankets, towellings, and glass cloths chiefly made in Germany prior to the war and in the United States of America was given at "The Textile Institute," Manchester, on Friday, March 28th, 1919. The lecturer was Mr. L. A. Porritt, of Messrs. William Tatham, Ltd., Rochdale.

Mr. Porritt explained that by "short fibre" he meant the shorter grades of Indian, Chinese, and Asiatic cotton with a staple of $\frac{5}{8}$ inch and under. Short staple cotton is only suitable as a weft yarn, and the main object being to produce a full and round thread the "condenser" system is the one universally adopted. Plant suitable for treating 25,000 lb. per week would be a hopper bale opener, delivering by lattice to a hopper feeder coupled to a porcupine opener, this to feed into a Crighton opener or not according to the amount of dirt, then through dust trunks to exhaust opener with beater and cages into a hopper feeder, delivering to single Buckley opener combined with single beater scutcher and lap machine. The loss between the bale and lap is about $7\frac{1}{2}$ per cent. to 15 per cent. The laps are double on 2 finisher scutcher lap machines. The delivery would be in laps for carding engines 48 inches to 50 inches wide, and by lattice delivery if for 60 inches to 70 inches wide, or if the cotton requires dyeing. On the

Continént the general custom is to use the wider widths. Carding is operated on the two card system, known as breaking and finishing. The carding engine is of the usual roller and clearer type which in order to get a woolly or oozy effect is the most suitable. The rollers are frequently 7 inches in diameter and the clearers $2\frac{1}{2}$ inches. The speed of the cylinders is 140 revolutions per minute, and so to prevent escape of dust and fly the cover over the "Fancy" receives special attention. A small clearer is placed between the cylinder and the doffer to prevent loss of fibre due to the quick speed of the cylinder. The undergrids are very stiff and can be accurately set. The finishing carding engine is similar, but has a leather type condenser. The set of engines in the mill described were 71 inches wide with 140 threads with four bobbins of 35 threads and 2 waste.

Very short stapled cotton could only be prepared for 4's to 8's counts by the "tape" condenser. The bobbins are taken to the "condenser" mule. In this type of mule the creels for roving bobbins are replaced by horizontal surface drums about 9 inches diameter, which unwind the condenser bobbins. There are two lines of bottom fluted rollers 1 inch diameter and one top leather covered roller 1 inch diameter. The draft is between the spindle and the roller and is about 2 to 1 for clean material and less for lower quality. The "condenser" mules for counts 4's and above are fitted with a treble spindle speed to give increased production and superior quality. The first speed is 1,800 revolutions for 18 inches of draw, then 2,700 revolutions until the carriage is nearly at full stretch, and then 5,000 for twisting up. There is $\frac{1}{2}$ motion to deliver $\frac{3}{4}$ inch to 1 inch of yarn before the carriage starts from the beam, in order to prevent the yarn being overstretched. When spindles 5 to 6 carriage makes about $4\frac{1}{2}$ draws per minute, for 7's to 8's under 4 draws. Production of 5's equals $4\frac{1}{2}$ lb.; 6's $3\frac{1}{2}$ lb.; 7's 3 lb.; and 8's $2\frac{3}{4}$ lb.

It is understood that the firm with which the lecturer is connected make a patent ring spinning frame for short cotton and waste. It is recommended where the material is comparatively clean. The threads pass from the condenser bobbin through a pair of delivery

rollers, $1\frac{1}{2}$ inch fluted bottom and $2\frac{1}{2}$ inches top plain, on through a twisting tube to the drawing $1\frac{1}{4}$ inch front fluted and $1\frac{3}{8}$ inch back pressure covered with leather and lever weighted and on to the ring and bobbin. Draft between delivery and drawing rollers from $1\frac{1}{2}$ to 2. Drawing is assisted by twisting tube which imparts a false twist to the roving. Production on 10's counts about 3 lb. per spindle. [*The Indian Trade Journal*, dated 7th November, 1919.]

* * *

AGRICULTURAL EDUCATION IN THE CENTRAL PROVINCES.

THE following is taken from a notice in "The Agricultural and Co-operative Gazette," Nagpur, June 1919, by Mr. J. H. Ritchie, Deputy Director of Agriculture, Northern Circle, Central Provinces :—

It is notified for general information that an Agricultural School for the sons of malguzars and well-to-do tenants will be opened on the Powarkheda Farm near Hoshangabad on the 1st June, 1919. The course, the syllabus of which is given below, will be for two years and will be half practical and half theoretical. Boys must first have passed the Upper Primary Class before joining.

Buildings have been constructed and a hostel for 32 boys will accommodate the students. On the farm there is a Sarai, and fathers of boys can put up there if they wish to see what their sons are doing. The department will probably manage to hold demonstrations to popularize the principal improvements if a sufficient number of parents assemble at the same time. It is proposed to allow 25 boys to enter the first year, and, as far as possible, this number will be allotted equally amongst the five districts of the Nerbudda Division.

No fees are being charged except a hostel fee of Rs. 2-8 a month to cover incidental expenses, e.g., servants, lighting, etc. The boys can make their own arrangements for cooking, but it would probably be preferable if they were to form a mess and have a cook who is being provided with all the necessary utensils.

Two teachers from the Education Department have been entertained after having received a training in agriculture at the Agricultural College in Nagpur. The Superintendent of the farm will also closely supervise their practical studies to ensure that the boys are being taught correctly.

The syllabus of study is given below :—

1. Reading—From special Agriculture Text-book being prepared.
2. Writing.
3. Arithmetic.—The best upper primary text-book to be used in conjunction with the text-book used at the Loni Agricultural School, Bombay Presidency. This subject will be taught with special reference to agricultural subjects.
4. Geography.—The best upper primary book to be used. Local geography and general physical geography.

First Year—

- (1) Propagation of plants by means of seeds, cuttings, budding and layering.
- (2) Seed—
 - (a) Plants and their use.
 - (b) Germination and its requirements.
 - (c) Germination percentage.
 - (d) Importance of good seed.
- (3) Necessity of soils for plant life.
- (4) Formation of soil in general.
- (5) Roots—
 - (a) Growth.
 - (b) Effect of light.
 - (c) Use to plants.
 - (d) Kinds.
- (6) Leaves—
 - (a) Different forms.
 - (b) Use to plants and their work.

(7) Insect life—

- (a) Stages of life.
- (b) Use of colour to insects.
- (c) Their mode of feeding.
- (d) Classification according to mouth parts.
- (e) Rearing of insects to study the different stages.
- (f) Information about crop pests in general and methods of destruction.
- (g) Insecticides and use of sprayers.

Second Year—

- (1) Insects of stored grain and cattle and how to destroy them.
- (2) Plant life continued—
 - (1) Flowers—
 - (a) Parts and use.
 - (b) Use to plant in seed formation.
 - (2) Dispersion of seed.
 - (3) Struggle for existence.
 - (4) Life-history of some plants.
 - (5) General information about fungus life and some common diseases with controlling measures.
 - (6) Parasitic plants.

The Nature Study will be mostly or generally practical to develop observation.

5. Village life—

- (1) Simple lessons on village sanitation.
- (2) Principles of marketing.
- (3) Advantages of co-operation.
- (4) Rural credit.
- (5) Village, Taluq and District administration.
- (6) System of land revenue in force.
- (7) Malguzari rights.
- (8) Reading and understanding of Patwarī maps.

6. Principles of agriculture—
 - (1) Classification of soils.
 - (2) Constituents of soils and their properties.
 - (3) Physical properties of soils
 - (4) Soil improvement.
 - (5) Irrigation.
 - (6) Manures.
 - (7) Crops.
 - (8) Vegetable growing.
 - (9) Animal husbandry.
 - (10) Milk.
7. Practical farm work.—Each boy will be allotted $\frac{1}{2}$ acre of land for growing staple crops on the group system and a plot for vegetable and fruit growing on the individual system.
8. Elementary carpentry and smithing.
9. Fruit and flower gardening.
10. Elementary land-surveying and crop-cutting experiments.

From the above syllabus it will be seen that a fairly comprehensive study of agricultural practice is intended. There will be very little really scientific study, as most of the time will be devoted to the study of Nature out of doors to help and develop the observation faculties of the boys and to stimulate their interest by making careful records of what they have seen.

The department cannot offer any post to students who pass through this course, as it is intended that such boys should return to their father's land to improve his cultivation.

* * *

THE following account of the working of the Federal Farm Loan Act of the United States by the New York Correspondent of the "Economist" will be read with interest :—

The Act was passed on July 17, 1916, and provided for the creation of two classes of institutions, both designed to lend money

at low rates of interest on improved farm properties. The first class of institutions is known as the Federal Land Banks, twelve of which were incorporated under the Act to operate in the twelve Federal Reserve Districts, which divide as nearly as possible into equal portions the whole area of the United States. These banks are limited to twelve in number, and their original capital was subscribed by purchase by the Treasury Department of the United States. After the organization was completed and the capital paid in, each bank proceeded to receive applications for farm loans based on 60 per cent. of the value of the land and 20 per cent. of the value of improvement on mortgages not exceeding a total of \$10,000 on any one farm. When these mortgages had been approved by the Federal Farm Loan Board at Washington, the funds were advanced by the individual banks to the borrowers, and the mortgages thus secured were deposited as collateral for the Federal Farm Loan $4\frac{1}{2}$ and 5 per cent. Bonds issued by the twelve banks and sold to the public, thus providing new fresh funds to continue the operation indefinitely. Federal Farm Loan $4\frac{1}{2}$ and 5 per cent. Bonds, while issued by each of the twelve individual banks, are jointly and severally guaranteed by all of the other banks. The Bonds have a maturity of 20 years, are optional after five years, and are deemed and held to be instrumentalities of the Government of the United States, and as such are free of all taxation except Inheritance Taxes. The Government does not, however, directly or indirectly guarantee the payment of either interest or principal, although the Federal Farm Loan Board is a bureau of the Treasury Department. The Supreme Court of the United States, in holding that the Bonds were instrumentalities of the Government did not state what an instrumentality was, nor has the point ever been conclusively answered by any court. When the banks were able to sell $4\frac{1}{2}$ per cent. Bonds profitably money was loaned to the farmers at $5\frac{1}{2}$ per cent., but when the market conditions became such that it was necessary to increase the rate on the bonds to 5 per cent., then advances were made on mortgage at 6 per cent. The law provides

that the banks can only charge the borrowing farmer 1 per cent. in excess of the cost of the money to the banks, and such banks may continue to loan until their outstanding Bonds secured by mortgages are equal to 20 times their capital stock, but since the provisions for capital increases are relatively simple, there is therefore no apparent end to the operation. The same Act provided for the creation of Joint Stock Land Banks without limit as to number, except that their scope of operation is limited to the State in which they are incorporated, and one contiguous State. Joint Stock Land Banks operate under Government charter and supervision, and lend money on identically the same terms as the twelve Federal Land Banks, except that they can take a mortgage of any size that the directors and Farm Loan Board approve. In addition to these differences, the capital stock of the Joint Stock Land Bank is privately owned, and their bonded debt limited to 15 times their capital stock, nor do these banks jointly and severally guarantee each other's debts, but are responsible simply for their own outstanding Bonds. Both systems have been a tremendous success, although the cry of class legislation has frequently been raised and efforts to nullify the tax exemption been repeatedly made. Mortgage loans of the Federal Farm Loan Banks amount to something over \$160,000,000 while the Land Banks have loaned in the neighbourhood of \$50,000,000. The former take care of the small borrower while the latter ordinarily get the business of the larger absentee landlords, who own and carry enormous properties in the North-West. As regards the Bonds themselves, both types have from the start proved extraordinarily attractive. The indirect liability of the United States Government, the tax exemption, the wonderful security provided by the collateral mortgages have all been factors of great appeal, and no public issue has been made without meeting an almost immediate response. The financing of the Federal Farm Loan Banks has always been handled by Alexander Brown and Sons, of Baltimore, while the Joint Stock Land Bank Bonds have almost from the beginning been placed by the Equitable Trust Company of New York.

POSITION OF SEED IN COTTON.

MR. G. L. KOTTUR writes in the "Poona Agricultural College Magazine" (July 1919):—

The writer was studying the causes of stunting in cotton when he happened to read "Natural History of Plants" by Kerner wherein the subject of the position of seed is treated in a very impressive manner. Kerner says that there are 7 kinds of cotyledons and in the seventh they require to be withdrawn from the seed-coat during germination. In this particular case, he says, the position of the seed is important. He cites the instance of the big and flat cucurbit seeds, and points out that the most favourable condition is obtained when the axis of the hypocotyl and radicle lie parallel to the surface of the ground. He further adds that when seeds of this sort are sown they usually assume this position.

Cotton, we know, withdraws its cotyledons from the seed-coat during germination and as such the author thought that the position of seed had some influence on stunting. He therefore began experiments on the subject, but before his observations were complete a paper was read by Rao Saheb M. L. Kulkarni at the Fifth Indian Science Congress in which the "tip up"¹ position was described as the most advantageous in cotton. The author however continued his experiments and the results which he obtained are given here.

One hundred seeds of the same weight were taken from a pure strain of cotton and sown in pots in three different positions: (1) Apex up, (2) Apex down, (3) Apex side. All the seeds were sown at the same depth, *viz.*, 1 inch, and the condition of the pots was kept uniform throughout. The following table shows the percentage of germination:—

Pot No.	Position of seed	No. of seed sown	GERMINATION			Total	COTYLEDONS	
			4th day	5th day	6th day		With coat on	Without coat
1	Apex up	100	4	90	0	94	1	93
2	Apex down	100	2	88	1	91	3	88
3	Apex side	100	6	90	2	98	0	98

¹ *Agric. Journ. of India*, Special Indian Science Congress Number, 1918.

A small percentage of these seedlings brought the seed-coat above the surface of the ground in the first two instances, the highest percentage being 3.3 in the case of apex down position. This shows that position has very little to do with the bringing off of the seed-coat. The radicle first elongates and fixes the seedling to the ground. The hypocotyl then grows but in the opposite direction, and a pressure is thus exerted on the seed-coat. If at this stage the seed-coat is firmly held in its position whatever the latter may be; the cotyledons are easily withdrawn leaving the coat in the ground. But if the seed-coat is not firmly cemented to the ground it comes like a cap above the surface. In loose soils and in shallow sowings the coat is not firmly fixed and a large number of seedlings bring the coat on their cotyledons in the case of all positions.

All the seedlings in the three pots were allowed to grow for about a fortnight and no difference in vigour was seen in favour of any position. The seedlings which had come up with the seed-coat, threw off the coat immediately and grew equally vigorous.

Later on another experiment was undertaken to ascertain the yields. In this experiment also, the seeds of one pure strain of the same weight were dibbled one inch deep on an even piece of land in the field. 112 seeds were thus sown 24 inches by 18 inches in each position. The following statement gives the result obtained:—

Serial number	Seed position	Number of seeds sown	NUMBER OF SEEDS GERMINATED ON					NUMBER OF SEED-LINGS OBTAINED		Total	Percentage of germination
			5th day	6th day	7th day	8th day	9th day	Without coat	With coat		
1	Apex up ...	112	4	86	2	1	0	85	8	93	83.04
2	„ down ...	112	0	93	0	0	1	78	16	94	84.82
3	„ side ...	112	0	99	0	0	0	83	16	99	88.39

The plants on the three plots were examined in the seedling stage and also later on, but it was not possible to detect any

difference in them. The following statement shows the yields obtained from these :—

Serial number	Seed position	PLANTS WHOSE COTYLEDONS HAD COME UP WITHOUT THE SEED-COAT			PLANTS WHOSE COTYLEDONS HAD COME UP WITH SEED-COAT			TOTAL		
		No. of plants	Yield of kapas in tolas	Per plant yield in tolas	No. of plants	Yield of kapas in tolas	Per plant yield in tolas	Plants	Yield of kapas in tolas	Per plant yield in tolas
1	Apex up ...	85	176	2.07	8	19½	2.44	93	195½	2.10
3	„ down ...	78	165	2.11	16	33	2.06	94	198	2.11
	„ side ...	83	173	2.09	16	35½	2.21	99	208½	2.11

The results of these experiments conducted with all possible care indicate that there is very little advantage to be gained by the position of seed in the case of cotton. There is no position which has an appreciable influence on the germination of the seed, vigour of seedlings or the yield of the individual plants.

* * *

AGRICULTURAL PESTS AND DISEASES ACT IN COIMBATORE DISTRICT.

THE following note has been issued by the Madras Publicity Bureau :—

A note has already been published explaining why the Pests Act has been put into force in the Coimbatore District. The public may be interested to hear something of the result of the application of the Act. The particular object aimed at was the eradication of all Cambodia cotton by the beginning of August, so that the bollworm moth, emerging from the diseased bolls, might during the next month find no fresh cotton plants wherein to lay her eggs. As no bollworm moth has been known to live for more than 34 days, this was calculated to effect an enormous mortality in bollworm circles.

The Act has been enforced with the smallest possible friction and so far from ryots being at all averse to the idea of pulling up a crop still capable of bearing something, they have raised no

objections, and in places have actually welcomed the step. It is as if they realized that it was bad farming to leave the crop in the ground, for the Coimbatore Gounden is an observant individual and a shrewd farmer, but that without the little bit of necessary compulsion they could not bring themselves to do what they realised they ought to. There have been so far as we can learn no proceedings taken under the Act and no opposition except in one tract where less than a hundred petitions are pending. This is a very satisfactory state of things and reflects great credit on all concerned, on the officers who had to see the Ordinance carried out, and on the ryots who in many cases suffered pecuniary loss. This latter has as a matter of fact not been much in any case: any man who had a field of Cambodia cotton in bearing must have already gathered a very heavy and profitable crop, and could quite well afford to lose the few and diseased bolls still remaining on the plant. The staff, from all accounts, interpreted the Act leniently, and since the sudden demand for labour was impossible to meet in some tracts, a few days' grace was permitted where asked for. The interpretation of the regulation and the explanation of its necessity and its bearing in the future crop of cotton were the work of the Agricultural Department subordinates, and right well they have done it. It seems odd to see a Brahmin assistant demonstrating to an interested crowd of Goundens, Naicks, or Gollas, the bollworm's habits and the damage it does.

A point the importance of which even our up-to-date Agricultural Department failed apparently to realize, was the great benefit which comes from grazing the field before pulling it out. The local ryot was acute enough to see that he saved both ways: he fed his cattle or his sheep, or at any rate got the dung from some one else's animals during the process, and at the same time he insured a much more certain destruction to the boll worm. Any one who has seen a field of cotton, after a herd of sheep and goats have finished with it, a bare ground with a few bare sticks on it, and never a sign of a boll or a leaf, and realizes what the digestive powers of a goat are, must realize that here we have the most potent instrument for bollworm destruction that could be devised.

WORLD'S FOOD CROP.

•THE following information has been issued by the International Agricultural Institute at Rome:—The yield of wheat in Spain, Scotland, Italy, Canada, the United States, India, Japan, and Tunis is estimated at 929,525,000 cwt. or 5·6 per cent. below the 1918 crop, and 1·1 per cent. below the average yield of the five years 1913–17. The estimated production of rye for Italy, Canada, and the United States is given as 48,274,000 cwt. or 7·1 per cent. below last year's production, but 67·3 per cent. above the average crop for the years 1913–17. The barley crop for Scotland, Italy, Canada, the United States, Japan, and Tunis is estimated at 159,397,000 cwt. or 15·1 per cent. below last year's production, and 4·1 per cent. above the average production of the years 1913–17. The estimated production of oats in Scotland, Italy, Canada, the United States, Japan, and Tunis is 491,933,000 cwt. or 18·4 per cent. below the 1918 yield, and 7·2 per cent. below the average yield of the five years 1913–17. The maize crop in Italy, Canada, and the United States is estimated at 1,473,592,000 cwt. or 10·2 per cent. above the 1918 production, and 3 per cent. above the average yield of the years 1913–17.

**PERSONAL NOTES, APPOINTMENTS AND TRANSFERS,
MEETINGS AND CONFERENCES, ETC.**

WE regret to record the death of Mr. D. Meadows, Civil Veterinary Department, Punjab, who was drowned in a *Jheel* while out for shooting.

WOODHOUSE-SOUTHERN MEMORIAL FUND.

	Rs.
DONATIONS received up to the 31st August, 1919, and acknowledged in the <i>Agricultural Journal of India</i> , Vol. XIV, Pt. V, October, 1919.	1,950
Donations received during the period from 1st September to 30th November, 1919 :—	
Miss B. Wright (S)	12
Alfred Wright, Esq. (S)	50
A. C. Dobbs, Esq.	100
R. C. Wood, Esq.	100
H. C. Sampson, Esq.	100
L. C. Coleman, Esq.	100
R. S. Finlow, Esq.	50
D. Chalmers, Esq., I.C.S.	40
J. H. Ritchie, Esq.	20
F. J. Plymen, Esq. (W)	20
G. P. Hector, Esq. (W)	20
TOTAL	Rs. 2,562

MR. J. C. B. DRAKE, O.B.E., I.C.S. (Bihar & Orissa), has been appointed Under Secretary to the Government of India, Department of Revenue and Agriculture, *vice* Mr. P. P. M. C. Plowden, I.C.S., whose services have been replaced at the disposal of the Government of the United Provinces.

* * *

MR. A. HOWARD, C.I.E., M.A., and Mrs. Gabrielle L. C. Howard, M.A., Imperial Economic Botanists, have been granted combined leave for 11 months.

* * *

MR. A. P. JAMESON, B.Sc., who has been appointed by the Secretary of State for India as Protozoologist at Pusa, joined his duties on the 17th October, 1919.

* * *

MR. R. CECIL WOOD, M.A., Offg. Director of Agriculture, Madras, has been granted combined leave for 18 months from or after 15th March, 1920.

* * *

MR. F. T. T. NEWLAND has been confirmed in his appointment of Government Agricultural Engineer, Madras.

* * *

ON return from military service, Mr. E. Ballard, B.A., F.E.S., has resumed the duties of Government Entomologist, Madras.

* * *

MR. A. WILSON, M.A., B.Sc., Deputy Director of Agriculture, Cinchona, Madras, has been granted privilege leave for six months with effect from the date of relief. Mr. E. Collins, Superintendent of the Naduvattam Cinchona Estate, will act for Mr. Wilson in addition to his own duties.

* * *

M. R. RY. M. V. RAGHAVALU NAYUDU has been appointed to act as Deputy Director of Agriculture, Live Stock, Madras, until further orders.

MR. E. J. BRUEN has been appointed Deputy Director of Agriculture for Animal Breeding, Bombay, with effect from the 16th September, 1919.

* * *

THE SECRETARY OF STATE has sanctioned the proposal to appoint Mr. V. A. Tamhane, M.Sc., L.Ag., to the post of Soil Physicist, Bombay, in the Indian Agricultural Service, after he goes through the requisite training in England.

* * *

MR. A. D. MCGREGOR, M.R.C.V.S., Offg. Superintendent, C.V.D., Bengal, has been confirmed in the Civil Veterinary Department.

* * *

MR. G. C. SHERRARD, B.A., Deputy Director of Agriculture, Bihar and Orissa, has been granted combined leave for one year.

* * *

MR. H. M. LEAKE, M.A., Economic Botanist to Government and Principal, Agricultural College, Cawnpore, has been appointed, on return from leave, to officiate as Director of Agriculture, United Provinces, *vice* the Hon'ble Mr. H. R. C. Hailey, C.I.E., I.C.S., granted privilege leave for six months.

* * *

MR. H. E. ANNETT, B.Sc., F.I.C., Agricultural Chemist to the Government of Bengal, on special duty in the United Provinces, has been granted combined leave for 17 months and 19 days, from the 12th April, 1919, exclusive of the period of his deputation in England for a period of six weeks.

* * *

MR. J. N. SEN, M.A., F.C.S., Supernumerary Agricultural Chemist, on special duty under the Government of the United Provinces, was on privilege leave for one month from the 19th November, 1919.

MR. T. RENNIE, M.R.C.V.S., Second Superintendent, Civil Veterinary Department, Burma, has been granted combined leave for ten months.

* * *

MR. E. SEWELL, M.R.C.V.S., who has been appointed to the Indian Civil Veterinary Department, has been posted as Professor of Sanitary Science in the Punjab Veterinary College.

* * *

ON return from leave, Mr. H. E. Cross, M.R.C.V.S., assumed charge of the office of Camel Specialist, Sohawa, on 27th October, 1919.

* * *

MR. G. EVANS, C.I.E., M.A., Deputy Director of Agriculture, Central Provinces, is on combined leave for eight months from the 5th July, 1919.

* * *

MR. C. P. MAYADAS, M.A., B.Sc., Assistant Director of Agriculture, Northern Circle, Central Provinces, has been transferred in the same capacity to the Western Circle from the 15th October, 1919.

Reviews

**A Manual for Co-operative Societies in the Bombay Presidency.—By
R. B. EW BANK, I.C.S.**

THE author of this book is the Registrar of Co-operative Societies in the Bombay Presidency, and he is not one of those that darken counsel by words without knowledge. His purpose, he tells us, is to place the accumulated experience of his department, in a simple form, at the disposal of the public. This purpose he has attained; and, after having searched Mr. H. W. Wolff's "Co-operation in India," and after having searched in vain, for definite guidance conveyed in clear English, it is with great relief that one turns to a book which is written by an expert who has not had the amazing temerity to write about a country, or rather a collection of countries, which he has never even seen. Mr. Ewbank has a great deal to say about Co-operation in the Bombay Presidency. And what he says is generally well expressed and always to the point, though never marred by that contention for the last word which is the bane of human relations. A man's opinions are not more important than the spirit and temper with which they possess him, and our author is clearly not one of those who are always insisting on better bread than can be made of wheat. In his fourth and fifth chapters Mr. Ewbank gives some valuable hints on the organization of agricultural credit societies. Regarding the number of members permissible in a credit society Mr. Wolff treats us to a lengthy discourse "about it and about," and, at the close, "we go out by that same door wherein we went." Mr. Ewbank gets to the root of the matter in a sentence. "Many societies in this Presidency have lost their

unity and become inefficient from the fact that they have allowed their membership to become unwieldy." Again, in his sixth chapter, our author tells us, in clear language, what the radical difference is between co-operative credit in the town and its country cousin. "An urban or limited society," he says, "is intended to meet conditions for which a rural or unlimited society is unsuitable. In country villages the members are usually thoroughly acquainted with each other's character, means, and behaviour, and know exactly how much money a particular person requires and how far he can be trusted. They are, therefore, not unwilling to accept joint and unlimited liability for each other. This joint and unlimited liability forms the basis of the credit of the society and enables it to raise funds from outside lenders. In a town, circumstances are different. Members of different classes or professions cannot all be acquainted with each other; they are usually artisans or traders who own very little land or real property and, therefore, have no very substantial property to offer. They want funds for their own business but do not want to be troubled with their neighbours' affairs. It would be unreasonable to expect such persons to submit to joint and unlimited liability."

In his ninth chapter, Mr. Ewbank explains the functions of "Guaranteeing Unions," from Mr. Wolff's adverse criticisms of which we venture to demur in the uplifted spirit of the Trodden Worm. "Guaranteeing Unions" are, in reality, nothing more than groups of societies, the members of which supervise each other and are responsible for each other's borrowings. It is upon the development of "Guaranteeing Unions" that the expansion of rural co-operative credit depends in India; for there are so few members of societies who are able to read and write that the promoter of rural economy must use an organization which is well calculated to get the greatest amount of public benefit from them. "A Union will sweep away delays," declares the Bombay Registrar. If it does, it will be a startling novelty in India, a country in which there is not much that is *jaldi* except the word.

Through the interesting chapters provided on District Central Banks, Provincial Banks, Stores, Cattle Insurance, and other

forms of co-operative effort we need not accompany Mr. Ewbank in this brief review. They are full of great thoughts from the heart, and, as expressed by a practical enthusiast, they go round by the head. In thirteen years the number of societies in the Bombay Presidency has increased from 12 to 1,650, membership from 219 to 156,805, and working capital from a few thousands of rupees to Rs. 1,62,89,000. For eight years Mr. Ewbank has guided the movement in his province, and if Registrars are to be known by their fruits, then, indeed, it is clear that the Bombay Presidency has been fortunate in securing the devoted services of the author of this book. [H. R. C.]

* * *

The Journal of Indian Botany, Vol. I, No. 1.—Edited by P. F. Fyson, B.A., F.L.S., Presidency College, Madras. [Printed and published by the Methodist Publishing House, Madras.] Price per annum, Rs. 10.

THIS is the first journal of its kind that has appeared in India. It is designed to be a means of publishing botanical work done in India. Up to date there has been very little opportunity for publishing articles on pure botanical matters. "The Journal of the Bombay Natural History Society" has often given such articles a home in its pages, but the need has been felt, for some time, for a magazine devoted entirely to botany.

The publications of the Agricultural and Forest Departments deal with botany as applied to these special subjects. The magazine under review deals with "pure" botany, meaning botany as a branch of knowledge, quite apart from its utilitarian aspects.

On this account it is of interest chiefly to professional botanists, and to botanical students. The number of persons in both these classes in India is now considerable, and it is hoped that they will support this new venture, which is to them a source of great benefit.

The present number is a modest blue-covered book of 32 pages, containing four original articles and a great number of notices of books and papers. These original articles compare well in matter

and style with those published in the newer botanical journals in Britain and America. The illustrations are well done, and intending contributors can see for themselves that their drawings will be properly reproduced.

Subscriptions should be sent to the Editor, Professor Fyson, Presidency College, Madras, by any manner found convenient. [W. B.]

* * *

First Report of the Bombay Central Co-operative Institute for the period ending the 31st March, 1919.

THE institute has recently been started, and has for its objects, among others, the development of the co-operative movement in all possible directions, the organization of junior and senior classes for educating the secretaries and other workers of co-operative societies, and the publication of periodicals, leaflets and books on the subject of co-operation in English as well as in the vernaculars of the presidency.

The report covers a period of six months only. Much of the time was necessarily spent on spade work and, in this, the workers appear to have made satisfactory progress. The institute has a large field of work before it and conducted as it is under the guidance of an experienced co-operator, Mr. R. B. Ewbank, I.C.S., it ought to fulfil its functions.

Thirty night schools in villages in which illiteracy hampers the progress of co-operation have already been opened, and it is expected to open ten more schools of the type. It is very gratifying to note that the promoter of this promising scheme—Sir Vithaldas D. Thakersey—has undertaken to pay the cost amounting to Rs. 60,000 and to continue to finance the scheme should it prove a success. [EDITOR.]

* * *

The Preliminary Report on the Water Power Resources in India.—By Mr. J. W. MEARES, M.I.C.E., Chief Engineer, Hydro Electric Survey. [Superintendent of Government Printing, Calcutta.]

THE report consists of 7 chapters, illustrated with excellent plates and maps, and 14 appendices containing the information

hitherto collected regarding the rivers and other possible sources of electric power in India and Burma.

The opening chapter contains a very clear exposition of the methods by which power can be developed from streams and reservoirs, and corrects the popular misconception that a natural waterfall like that in the Cauvery or at Niagara is necessary. The importance to India of combined schemes of irrigation and power is also clearly brought out. Further on, "Weather and Water," "Localities and Surveys," "Power and its Uses," are dealt with. Then follows a chapter on State control, charges for water power and leases and agreements. Chapter six summarizes our present knowledge of the water power already developed, under development, and examined with a view to development. A general description is given of the conditions in each province as an introduction to the "Lists of Sites" in the Appendices.

The final chapter puts forward a constructive programme for the further work of the survey in its various aspects, and calls attention to specially favourable sites for survey and perhaps development.

So far as the preliminary investigation has gone—and it is admittedly incomplete—India's industries now absorb a matter of over a million horse power, of which only some 285,000 is supplied by electricity from steam, oil or water. The water power so far actually in sight amounts to $1\frac{3}{4}$ million horse power, but this excludes practically all the great rivers at present uninvestigated. Thus it is stated that the minimum flow of the seven great rivers eastward from the Indus is capable of giving no less than 3 million horse power for every thousand feet of their fall from the Himalayas, while similar considerations apply to rivers in other parts. Some doubt, however, is expressed as to the estimate of seven million horse power in the Irrawaddy and Chindwin rivers, given in the Report of the Conjoint Board of Scientific Societies.

While Bombay is in an especially favourable position in respect to water power, Bengal at present depends on its coal fields, though it has the honour of owning the first hydro-electric station in India at Darjeeling. In this neighbourhood, the report shows that great

power is available from the Teesta, the Jaldaka and other rivers of Bengal and Bihar. What is now wanted is a capitalist to develop these potential sources of wealth.

The first edition of 2,000 has been practically taken up for official use and a second impression has already been ordered.

NEW BOOKS

ON AGRICULTURE AND ALLIED SUBJECTS

1. **A Large State Farm: A Business and Educational Undertaking**, by Lt.-Col. A. G. Weigall and Castell Wrey. Pp. xiii+82. (London: John Murray.) Price, 2s. 6d. net.
2. **The Flower and the Bee: Plant Life and Pollination**, by J. H. Lovell. Pp. xvii+286. (London: Constable & Co., Ltd.) Price, 10s. 6d. net.
3. **The Farmer and the New Day**, by K. L. Butterfield. Pp. ix+311. (London: Macmillan & Co., Ltd.) Price, 8s. 6d. net.
4. **The Fauna of British India, including Ceylon and Burma. Coleoptera, Chrysomelidæ (Hispinæ and Cassidinæ)**, by Prof. S. Maulik. Pp. xi+439. (London: Taylor & Francis.)
5. **The Cactaceæ: Descriptions and Illustrations of Plants of the Cactus Family**, by N. L. Britton and J. N. Rose. Vol. I. (Washington: The Carnegie Institution.)
6. **Problems of Fertilization**, by Prof. F. R. Lillie. (University of Chicago Science Series.) Pp. xii+278. (London: Cambridge University Press.) Price, 1.75 dollars.
7. **A Source-book of Biological Nature-study**, by E. R. Downing. (University of Chicago Nature-study Series.) Pp. xxi+503. (London: Cambridge University Press.) Price, 3 dollars.
8. **Mining and Manufacture of Fertilizing Materials and their Relation to Soils**, by S. E. Lloyd. Pp. vi+153. (London: Crosby Lockwood & Son.) Price, 9s. net.
9. **Mathematics for Collegiate Students of Agriculture and General Science**, by Profs. A. M. Kenyon and W. V. Lovitt. Revised edition. Pp. xii+337. (London: Macmillan & Co., Ltd.) Price, 10s. 6d. net.

10. **First Advice to Would-be Farmers**, by E. E. Green. Pp. 190. (London: "Country Life" Offices.) Price, 5s. net.
11. **Note-book of Agricultural Facts and Figures for Farmers and Farm Students**, by P. McConnell. Pp. 538. (London: Crosby Lockwood.) Price, 15s. net.
12. **The Silk Industry and Trade: A Study in the Economic Organization of the Export Trade of Kashmir and Indian Silk, with Special Reference to their Utilization in the British and French Markets**, by Ratan C. Rawley. Pp. xvi+172. (London: P. S. King & Son.) Price, 10s. 6d. net.
13. **Birds Beneficial to Agriculture: Economic Series No. 9 British Museum (Natural History)**, by F. W. Frohawk. Pp. vi+47. [London: British Museum (Natural History).] Price, 2s.
14. **The Planting, Cultivation, and Expression of Coconuts, Kernels, Cacao, and Edible Vegetable Oils and Seeds of Commerce. A Practical Handbook for Planters, Financiers, Scientists and others**, by H. Osman Newland. (Griffin's Technological Handbooks.) Pp. vi+111+xi plates. (London: Charles Griffin & Co.)
15. **Heredity**, by Prof. J. Arthur Thomson. Third edition. (The Progressive Science Series.) Pp. xvi+627. (London: John Murray.) Price, 10s. net.
16. **Catalysis in Theory and Practice**, by Dr. E. K. Rideal and Prof. H. S. Taylor. Pp. xv+496. (London: Macmillan & Co.) Price, 17s. net.
17. **Insect Artizans and their Work**, by Edward Step. (Hutchinson's Nature Library.) Pp. x+318. (London: Hutchinson & Co., n. d.) Price, 7s. 6d. net.
18. **Insect Pests and Plant Diseases in the Vegetable and Fruit Garden**, by F. Martin Duncan. Pp. 95+xii plates. (London: Constable & Co.) Price, 3s. 6d. net.
19. **The Condensed Chemical Dictionary**, compiled and edited by the Editorial Staff of the Chemical Engineering Catalogue. Pp. 525. (New York: The Chemical Catalogue Co., Inc.) Price, 5 dollars.

20. Applied Economic Botany based upon actual Agricultural Gardening Projects, by Dr. M. T. Cook. Pp. xviii+261. (Philadelphia and London: J. B. Lippincott.) Price, 7s. 6d. net.

THE following publications have been issued by the Imperial Department of Agriculture in India since our last issue :—

Memoirs.

1. Absorption of Lime by Soils, by F. J. Warth, M.Sc., B.Sc., and Maung Po Saw. (Chemical Series, Vol. V, No. 6.) Price, R. 1-2 or 2s.
2. A *Pythium* Disease of Ginger, Tobacco and Papaya, by L. S. Subramaniam. (Botanical Series, Vol. X, No. 4.) Price, Rs. 1-8 or 2s. 6d.

Bulletins.

1. A Contribution to Our Knowledge of South Indian Coccidæ, by T. V. Ramakrishna Ayyar, B.A., F.E.S., F.Z.S. (Bulletin No. 87.) Price, As. 14 or 1s. 3d.
2. Second Hundred Notes on Indian Insects. (Bulletin No. 89.) Price, R. 1-4 or 2s.
3. A Malarial Parasite in the Blood of a Buffalo, by A. L. Sheather, B.Sc., M.R.C.V.S. (Bulletin No. 90.) Price, As. 6 or 7d.

Reports.

1. Proceedings of the First Meeting of Agricultural Chemists and Bacteriologists held at Pusa on 24th February, 1919, and the following days. Price, R. 1 or 1s. 6d.
2. Scientific Reports of the Agricultural Research Institute, Pusa (including the Report of the Imperial Cotton Specialist), for the year 1918-19. Price, R. 1-4 or 2s.
3. Annual Report of the Imperial Bacteriological Laboratory, Muktesar, for the year ending the 31st March, 1919. Price As. 4 or 5d.

Miscellaneous.

1. Guide to Agricultural Section, Pusa.

PUBLICATIONS OF THE IMPERIAL DEPARTMENT OF AGRICULTURE IN INDIA

TO BE HAD FROM

THE OFFICE OF THE AGRICULTURAL ADVISER TO THE GOVERNMENT OF INDIA, PUSA, BIHAR,
and from the following Agents :—

- | | |
|--|---|
| (1) THACKER, SPINK & CO., CALCUTTA. | (7) THACKER & CO., LTD., BOMBAY. |
| (2) W. NEWMAN & CO., CALCUTTA. | (8) SUNDER PANDURANG, BOMBAY. |
| (3) RAI M. C. SARKAR BAHADUR & SONS, CALCUTTA. | (9) RAI SAHIB M. GULAB SINGH & SONS, LAHORE. |
| (4) HIGGINBOTHAMS, LTD., MADRAS. | (10) MANAGER, EDUCATIONAL BOOK DEPOT, NAGPUR. |
| (5) THOMPSON & CO., MADRAS. | |
| (6) D. B. TARAPOREVALA, SONS & CO., BOMBAY. | |

A complete list of the publications of the Imperial Department of Agriculture in India can be obtained on application from the Agricultural Adviser to the Government of India, Pusa, Bihar, or from any of the above-mentioned Agents.

These publications are :—

1. *The Agricultural Journal of India*. A Journal dealing with subjects connected with agricultural economics, field and garden crops, economic plants and fruits, soils, manures, methods of cultivation, irrigation, climatic conditions, insect pests, fungus diseases, co-operative credit, agricultural cattle, farm implements, and other agricultural matters in India. Illustrations, including coloured plates, form a prominent feature of the Journal. It is edited by the Agricultural Adviser to the Government of India, and is issued once every two months or six times a year. *Annual Subscription*, Rs. 6 or 9s. 6d., including postage. Single copy, R. 1-8 or 2s.
2. Scientific Reports of the Agricultural Research Institute, Pusa (including the Report of the Imperial Cotton Specialist).
3. Annual Report on the Progress of Agriculture in India.
4. Proceedings of the Board of Agriculture in India.
5. Proceedings of Sectional Meetings of the Board of Agriculture.
6. Memoirs of the Imperial Department of Agriculture in India :
 - (a) Botanical Series.
 - (b) Chemical Series.
 - (c) Entomological Series.
 - (d) Bacteriological Series.
 - (e) Veterinary Series.
7. Bulletins issued by the Agricultural Research Institute, Pusa.
8. Books.

The following are the publications of the last two years :—

Scientific Reports of the Agricultural Research Institute and College, Pusa (including the Report of the Imperial Cotton Specialist), for the year 1917-18. Price, R. 1-4 or 2s.

AGRICULTURAL PUBLICATIONS.—(Conold.)

- Scientific Reports of the Agricultural Research Institute, Pusa (including the Report of the Imperial Cotton Specialist), for the year 1918-19. Price, R. 1-4 or 2s.
- Report on the Progress of Agriculture in India for the year 1916-17. Price, As. 12 or 1s. 1d.
- Report on the Progress of Agriculture in India for the year 1917-18. Price, R. 1-8 or 2s. 3d.
- Proceedings of the Board of Agriculture in India, held at Poona on the 10th December, 1917, and following days (with Appendices). Price, As. 13 or 1s. 3d.
- Proceedings of the Second Meeting of Mycological Workers in India, held at Pusa on the 20th February, 1919, and following days. Price, As. 11 or 1s.
- Proceedings of the First Meeting of Agricultural Chemists and Bacteriologists, held at Pusa on 24th February, 1919, and the following days. Price, R. 1 or 1s. 6d.
- Proceedings of the First Meeting of Veterinary Officers in India, held at Lahore on the 24th March, 1919, and following days (with Appendices). Price, As. 8 or 9d.

MEMOIRS OF THE DEPARTMENT OF AGRICULTURE IN INDIA

BOTANICAL SERIES

- Vol. IX, No. IV. Studies in Indian Sugarcanes, No. 3. The Classification of Indian Canes with special reference to the Sarsetha and Sunnabile Groups, by C. A. BARBER, sc.D. Price, Rs. 2-4 or 3s.
- Vol. IX, No. V. *Phytophthora Meadii* n. sp. on *Hevea brasiliensis*, by W. MORAE, M.A., B.Sc., F.L.S. Price, R. 1-4 or 2s.
- Vol. X, No. I. The Rice Worm (*Tylenchus angustus*) and its Control, by E. J. BUTLER, M.B., F.L.S. Price, R. 1-4 or 2s.
- Vol. X, No. II. Studies in Indian Sugarcanes, No. 4. Tillering or Underground Branching, by C. A. BARBER, C.I.E., sc.D., F.L.S. Price, Rs. 4-4 or 7s.
- Vol. X, No. III. Studies in Indian Sugarcanes, No. 5. On testing the suitability of sugarcane varieties for different localities, by a system of measurements. Periodicity in the growth of the sugarcane, by C. A. BARBER, C.I.E., sc.D., F.L.S. Price, R. 1-12 or 3s.
- Vol. X, No. IV. A *Pythium* Disease of Ginger, Tobacco and Papaya, by L. S. Subramaniam. Price, R. 1-8 or 2s. 6d.
- Vol. X, No. V. Studies in the Pollination of Indian Crops, 1, by A. HOWARD, GABRIELLE L. C. HOWARD, and ABDUR RAHMAN KHAN. (*In the press.*)

CHEMICAL SERIES

- Vol. V, No. II. "Heart Damage" in Baled Jute, by R. S. FINLOW, B.Sc., F.I.C., F.O.S. Price, R. 1 or 1s. 6d.
- Vol. V, No. III. Experiments on the Improvement of the Date Palm Sugar Industry in Bengal, by HAROLD E. ANNETT, B.Sc., F.I.C.; GOSTA BEHARI PAL, M.Sc.; and INDU BHUSHAN CHATTERJEE, L.A.G. Price, R. 1 or 1s. 6d.
- Vol. V, No. IV. Cholam (*A. Sorghum*) as a Substitute for Barley in Malting Operations, by B. VISWANATH, T. LAKSHMANA ROW, B.A., and P. A. RAGHUNATHASWAMI AYYANGAR, Dip. ag. Price, As. 12 or 1s.
- Vol. V, No. V. The Phosphate Requirements of some Lower Burma Paddy Soils, by F. J. WARTH, M.Sc., B.Sc., and MAUNG PO SHIN. Price, R. 1-12 or 3s. 3d.
- Vol. V, No. VI. Absorption of Lime by Soils, by F. J. WARTH, M.Sc., B.Sc., and MAUNG PO SAW. Price, R. 1-2 or 2s.

ENTOMOLOGICAL SERIES

- Vol. V, No. V. The Rice Leaf-hoppers (*Nephotettix bipunctatus*, Fabr. and *Nephotettix apicalis*, Motsch.), by C. S. MISRA, B.A. (*In the press.*)
- Vol. V, No. VI. *Lantana* Insects in India. Being the Report of an Inquiry into the Efficiency of Indigenous Insect Pests as a Check on the Spread of *Lantana* in India, by Y. RAMACHANDRA RAO, M.A., F.R.S. (*In the press.*)

BACTERIOLOGICAL SERIES

Vol. I, No. VII. **A Bacterial Disease of Wheat in the Punjab**, by C. M. HUTCHINSON, B.A.
Price, As. 12 or 1s.

VETERINARY SERIES

Vol. II, No. VIII. **Kumri: Combined Diffuse Sclerosis and Central Poliomyelitis of Horses**,
by G. H. K. MACALISTER, M.A., M.D., D.P.H. Price, R. 1-8 or 2s. 6d.

Vol. III, No. I. **The Vitality of the Rinderpest Virus outside the Animal Body under
Natural Conditions**, by A. W. SHILSTON, M.R.C.V.S. Price, As. 12 or 1s.]

BULLETINS ISSUED BY THE AGRICULTURAL RESEARCH INSTITUTE, PUSA

- No. 76. **Experiments with Emulsions for Protecting Camels against the Attacks of Blood-sucking Flies**, by H. E. CROSS, M.R.C.V.S., D.V.H., A.Sc. Price, As. 2 or 3d.
- No. 77. **Some Camel-feeding Experiments**, by H. E. CROSS, M.R.C.V.S., D.V.H., A.Sc. Price, As. 2 or 3d.
- No. 78. **Smuts of Jowar (*Sorghum*) in the Bombay Presidency**, by G. S. KULKARNI, L.A.G. Price, As. 4 or 5d.
- No. 79. **Prussic Acid in Burma Beans**, by F. J. WARTH, B.Sc., M.Sc.; and KO] KO GYL. Price, As. 2 or 3d.
- No. 80. **Are Camels Susceptible to Black Quarter, Hæmorrhagic Septicæmia and Rinderpest?** by H. E. CROSS, M.R.C.V.S., D.V.H., A.Sc. Price, As. 4 or 5d.
- No. 81. **The Value of Phosphatic Manures in India and the Possibility of their Manufacture on a Larger Scale.** Being evidence submitted to the Committee appointed to discuss this question (Subject IX) at the Meeting of the Board of Agriculture, Poona, 1917. Edited, with an Introduction, by W. A. DAVIS, B.Sc., A.C.G.I. Price, As. 4 or 5d.
- No. 82. **The Improvement of the Indigenous Methods of Gur and Sugar making in the United Provinces**, by WILLIAM HULME and R. P. SANGHI. Price, As. 8 or 9d.
- No. 83. **Progress of the Sugarcane Industry in India during the Years 1915 and 1917.** Being Notes submitted to the Meeting of the Board of Agriculture in India, Poona, 1917. Edited, with an Introduction, by C. A. BARBER, C.L.E., Sc.D., F.L.S. Price, As. 5 or 6d.
- No. 84. **The Best Means of Rapidly Increasing the Outturns of Food Crops by Methods within the Power of the Agricultural Department.** Being Notes submitted to the Meeting of the Board of Agriculture in India, Poona, 1917. Edited, with an Introduction, by J. MACKENNA, C.L.E., L.C.S. Price, As. 4 or 5d.
- No. 85. **Soil Drainage**, by R. G. ALLAN, M.A. Price, As. 4 or 5d.
- No. 86. **A New Nematode causing Parasitic Gastritis in Calves**, by A. L. SHEATHER, B.Sc., M.R.C.V.S. Price, As. 4 or 5d.
- No. 87. **A Contribution to our Knowledge of South Indian Coccidæ**, by T. V. RAMAKRISHNA AYYAR, B.A., F.E.S., F.Z.S. Price, As. 14 or 1s. 6d.
- No. 88. **Cawnpore-American Cotton: An Account of Experiments in its Improvement by Pure Line Selection and of Field Trials, 1913-1917**, by B. C. BURT, B.Sc., and NIZAMUDDIN HAIDER. Price, As. 10 or 1s.
- No. 89. **Second Hundred Notes on Indian Insects.** Price, R. 1-4 or 2s.
- No. 90. **A Malarial Parasite in the Blood of a Buffalo**, by A. L. SHEATHER, B.Sc., M.R.C.V.S. Price, As. 6 or 7d.
- No. 91. **Notes on Practical Salt Land Reclamation**, by G. S. HENDERSON, N.D.A., N.D.D. (*In the press.*)
- No. 92. **Syngamus laryngeus in Cattle and Buffaloes in India**, by A. LESLIE SHEATHER, B.Sc., M.R.C.V.S., and A. W. SHILSTON, M.R.C.V.S. (*In the press.*)
- No. 93. **The Orange: The Trial of Stocks at Peshawar**, by W. ROBERTSON BROWN. (*In the press.*)

**BULLETINS ISSUED BY THE AGRICULTURAL RESEARCH
INSTITUTE, PUSA—(Concl'd.)**

- No. 94. A Preliminary Note on the Behaviour in North India of the first batch of Sugarcane Seedlings raised at the Sugarcane-breeding Station, Coimbatore, by T. S. VENKATARAMAN, B.A. (*In the press.*)

INDIGO PUBLICATIONS

- No. 1. A Study of the Indigo Soils of Bihar. The Urgent Necessity for Immediate Phosphate Manuring if Crops are to be Maintained, by W. A. DAVIS, B.Sc., A.C.G.I. Price, R. 1-4 or 2s.
- No. 2. Present Position and Future Prospects of the Natural Indigo Industry, by W. A. DAVIS, B.Sc., A.C.G.I. Price, As. 10 or 1s.
- No. 3. The Loss of Indigo caused by Bad Settling and the means of obviating this: The use of Dhak Gum—its Effect on Yield and Quality, by W. A. DAVIS, B.Sc., A.C.G.I. Price, As. 4 or 5d.
- No. 4. The Future Prospects of the Natural Indigo Industry: The Effect of Superphosphate Manuring on the Yield and Quality of the Indigo Plant, by W. A. DAVIS, B.Sc., A.C.G.I. Price, As. 4 or 5d.
- No. 5. An Improved Method of preparing Indican from Indigo-yielding Plants, by BHAILAL M. AMIN, B.A. Price, As. 2 or 3d.
- No. 6. The Effect of Manuring with Superphosphate and Sannai on the Yield of Crops on Indigo Planters' Estates in Bihar—especially of Rabi Crops in the Season 1918-1919, by W. A. DAVIS, B.Sc., A.C.G.I. (*In the press.*)

BOOKS

- "Indian Insect Pests," by H. MAXWELL-LEFROY, M.A., F.E.S., F.Z.S. Price, R. 1-8 or 2s. (*Out of print.*)
- "Indian Insect Life," by H. MAXWELL-LEFROY, M.A., F.E.S., F.Z.S.; and F. M. HOWLETT, B.A. 786 pp. Price, Rs. 20 or 30s. (*Out of print.*)
- Wheat in India," by ALBERT HOWARD, M.A., A.R.C.S., F.L.S.; and GABRIELLE L. C. HOWARD, M.A. 288 pp. Price, Rs. 5 or 7s. 6d.
- "A Description of the Imperial Bacteriological Laboratory, Muktesar: Its Work and Products," by Major J. D. E. HOLMES, M.A., D.Sc., M.R.C.V.S. Price, As. 8 or 9d.
- "Agriculture in India," by JAMES MACKENNA, M.A., I.C.S. Price, As. 4 or 5d.
- "Some Diseases of Cattle in India. A handbook for stock-owners." Price, As. 8 or 9d.
- "The Importance of Bacterial Action in Indigo Manufacture," by C. M. HUTCHINSON, B.A. Price, As. 2 or 3d.
- "Report of the Proceedings of the Second Entomological Meeting, held at Pusa on the 5th-12th February 1917." Price, Rs. 3.
- Report of the Indian Cotton Committee. Vol. I, Report; Vol. II, Maps and plans. Price, R. 1 per volume. (Superintendent: Government Printing, India, Calcutta.)

VOL. XV, PART II

March, 1920

THE AGRICULTURAL JOURNAL OF INDIA



EDITED BY

The Agricultural Adviser to the Government of India

PUBLISHED FOR

THE IMPERIAL DEPARTMENT OF AGRICULTURE IN INDIA

BY

THACKER, SPINK & CO., CALCUTTA

W. THACKER & CO., 2, CREED LANE, LONDON

Price R. 1-8 or Two Shillings

Agents for the Sale of Government Publications

IN EUROPE

- Constable & Co., 10, Orange Street, Leicester Square, London, W.C.
Kegan Paul, Trench Trübner & Co., 68-74, Carter Lane, E.C., and 25, Museum Street, London, W.C.
Bernard Quaritch, 11, Grafton Street, New Bond Street, London, W.
P. S. King & Sons, 2 & 4, Great Smith Street, Westminster, London, S.W.
H. S. King & Co., 65, Cornhill, E.C., and 9, Pall Mall, London, W.
Grindlay & Co., 54, Parliament Street, London, S.W.
Luzac & Co., 46, Great Russell Street, London, W.C.
W. Thacker & Co., 2, Creed Lane, London, E.C.
T. Fisher Unwin, Limited, 1, Adelphi Terrace, London, W.C.
B. H. Blackwell, 50 & 51, Broad Street, Oxford.
Deighton, Bell & Co., Ltd., Cambridge.
Oliver & Boyd, Tweeddale Court, Edinburgh.
E. Ponsonby, Ltd., 116, Grafton Street, Dublin.
Ernest Leroux, 28, Rue Bonaparte, Paris.
Martinus Nijhoff, The Hague, Holland.

IN INDIA AND CEYLON

- Thacker, Spink & Co., Calcutta and Simla.
W. Newman & Co., Calcutta.
R. Cambray & Co., Calcutta.
S. K. Lahiri & Co., Calcutta.
B. Bannerjee & Co., Calcutta.
The Indian School Supply Depôt, 309, Bow Bazar Street, Calcutta, and 226, Nawabpur, Dacca.
Butterworth & Co. (India), Ltd., Calcutta.
Rai M. C. Sarkar Bahadur & Sons, 75-1-1, Harrison Road, Calcutta.
The Weldon Library, 18-5, Chowringhee Road, Calcutta.
Standard Literature Co., Ltd., Calcutta.
Lal Chand & Sons, Calcutta.
Higginbothams, Ltd., Madras.
V. Kaliyanarama Iyer & Co., Madras.
G. A. Natesan & Co., Madras.
S. Murthy & Co., Madras.
Thompson & Co., Madras.
Temple & Co., Madras.
P. R. Rama Iyer & Co., Madras.
E. M. Gopalakrishna Kone, Madura.
Thacker & Co., Ltd., Bombay.
A. J. Combridge & Co., Bombay.
D. B. Taraporevala, Sons & Co., Bombay.
Mrs. Radhabai Atmaram Sagoon, Bombay.
Sunder Pandurang, Bombay.
Gopal Narayan & Co., Bombay.
Ramchandra Govind & Son, Kalbadevi, Bombay.
A. H. Wheeler & Co., Allahabad, Calcutta, and Bombay.
N. B. Mathur, Superintendent, Nazir Kanun-i-Hind Press, Allahabad.
Rai Sahib M. Gulab Singh & Sons, Mufid-i-Am Press, Lahore.
A. Chand & Co., Lahore, Punjab.
Ram Krishna & Sons, Lahore.
Superintendent, American Baptist Mission Press, Rangoon.
Manager, the "Hitavada," Nagpur.
S. C. Talukdar, Proprietor, Students & Co., Cooch Behar.
A. M. & J. Ferguson, Colombo, Ceylon.
Manager, Educational Book Depôts, Nagpur and Jubbulpore.*
Manager of the Imperial Book Depôt, 63, Chandney Chauk Street, Delhi.*
Manager, "The Agra Medical Hall and Co-operative Association, Ltd." (Successors to A. John & Co., Agra.)*
Superintendent, Basel Mission Book and Tract Depository, Mangalore.*
P. Varadachary & Co., Madras.*
H. Liddell, Printer, etc., 7, South Road, Allahabad.*
D. C. Anand & Sons, Peshawar.*
Ram Dayal Agarwala, 184, Katra, Allahabad.*
Manager, Newal Kishore Press, Lucknow.*

* Agents for the sale of Legislative Department Publications only

CONTENTS

(VOL. XV, PART II)

ORIGINAL ARTICLES

	PAGE
SOME COMMON INDIAN BIRDS. No. 2—THE BLUE-TAILED BEE-EATER (<i>Merops philippinus</i>)	121
	T. Bainbrigge Fletcher, R.N., F.L.S., F.E.S., F.Z.S.; and C. M. Inglis, M.B.O.U.
INVESTIGATIONS CONCERNING THE PRODUCTION OF INDIAN OPIUM FOR MEDICAL PURPOSES	124
	H. M. Leake, M.A., F.L.S.; and H. E. Annett, B.Sc., F.I.C., F.C.S.
THE ELEVENTH MEETING OF THE BOARD OF AGRICULTURE IN INDIA	135
	F. J. F. Shaw, D.Sc., A.R.C.S., F.L.S.
THE MOTOR TRACTOR IN AGRICULTURE: SOME IMPRESSIONS OF THE TRACTOR TRIALS HELD AT LINCOLN IN SEPTEMBER 1919	144
	T. F. Main, B.Sc.
NOTES ON THE PROGRESS OF THE EUROPEAN OLIVE AT PESHAWAR	150
	W. Robertson Brown
THE DEVELOPMENT OF CANE PLANTING BY THE EAST INDIA DISTILLERIES AND SUGAR FACTORIES, LTD.	154
	Messrs. Parry & Co.
DEVELOPMENT OF IRRIGATION FROM BHIND CANAL: A PLEA FOR ECONOMICAL USE OF WATER	160
	S. K. Gurtu, M.A., M.I.C.E.
THE DRYING OF BANANAS	166
	W. Burns, D.Sc., and P. G. Joshi
PACKING SEED SUGARCANES FOR TRANSPORT	174
	T. S. Venkatraman, B.A.

	Page
SWARMING CATERPILLARS OF NORTHERN GUJARAT T. N. Jhaveri, L.Ag. ..	181

SELECTED ARTICLES

THE GROWTH OF SUGARCANE	185
WHAT THE TUCUMAN EXPERIMENT STATION HAS DONE FOR THE ARGENTINE SUGAR INDUSTRY	191
THE WORLD'S SUGAR SUPPLIES	201
BOTANY AND ITS ECONOMIC APPLICATIONS IN THE EMPIRE	207

NOTES

HALF-BRED AYRSHIRE-MONTGOMERY CATTLE AT PESHAWAR	217
THE BRITISH EMPIRE SUGAR RESEARCH ASSOCIATION	219
THE ELECTRICAL TREATMENT OF SEEDS	221
FLOUR FROM THE CATTAILS OF THE SWAMPS	222
MANGO HOPPER PEST	222

PERSONAL NOTES, APPOINTMENTS AND TRANSFERS, MEETINGS AND CONFERENCES, ETC.	225
--	------------

REVIEWS

BOTANY FOR AGRICULTURAL STUDENTS, AND BOTANY OF CROP PLANTS	229
DRAINAGE FOR PLANTATIONS: A PRACTICAL HANDBOOK	230

NEW BOOKS ON AGRICULTURE AND ALLIED SUBJECTS	232
---	------------

LIST OF ILLUSTRATIONS

The Blue-tailed Bee-eater (<i>Merops philippinus</i>)	Frontispiece
Plate VIII. European olive trees, six years old, before they were transplanted	Facing page 151
„ IX. Steam plough at work on dry land	156
„ X. A Nellikuppam cane field	157
„ XI. Packing of seed sugarcane for transport	174
„ XII. Ditto	175
„ XIII. Growth of sugarcane	187
„ XIV. Awankari and Ayrshire-Montgomery bull- calves	218

The half-yearly lists of agricultural publications in India will, in future, be published in the May and November issues of the Journal.

*The following Original Articles will appear in our next issue
(May 1920).*

- SOME COMMON INDIAN BIRDS. No. 3.—THE
SPOTTED OWLET (*Athena brama*) .. *T. Bainbrigge Fletcher, R.N.,
F.L.S., F.E.S., F.Z.S.;
and C. M. Inglis,
M.B.O.U.*
- SOME ASPECTS OF COTTON IMPROVEMENT IN
INDIA *H. C. Sampson, B.Sc.*
- THE POSSIBILITIES OF AGRICULTURE IN INDIA
WITHIN THE NEXT TWENTY YEARS .. *D. Clouston, C.I.E., M.A.,
B.Sc.*
- SOME ASPECTS OF PLANT GENETICS .. *W. Burns, D.Sc.*
- THE *Tamera* DISEASE OF POTATO .. *Harold H. Mann, D.Sc.,
S. D. Nagpurkar, B.Ag.,
and G. S. Kulkarni, L.Ag.*
- THE BIOLOGICAL ASPECT OF WHEAT CULTI-
VATION ON EMBANKED SOILS *F. J. Plymen, A.C.G.I.,
and D. V. Bal, L.Ag.*



THE BLUE-TAILED BEE-EATER (*MEROPS PHILIPPINUS*)

Original Articles

SOME COMMON INDIAN BIRDS.

No. 2. THE BLUE-TAILED BEE-EATER (*MEROPS PHILIPPINUS*).

BY

T. BAINBRIGGE FLETCHER, R.N., F.L.S., F.E.S., F.Z.S.,
Imperial Entomologist;

AND

C. M. INGLIS, M.B.O.U.

OUR last paper¹ dealt with a useful bird—useful, that is, so far as agriculture is concerned—but the same adjective cannot be applied to the Blue-tailed Bee-eater, as it is on the whole an injurious species by preying on beneficial insects.

In appearance and habits it is much like its commoner and smaller, but equally noxious, relative, the Common Indian Bee-eater (*Merops viridis*), from which it is distinguishable by its chestnut throat (green or bluish-green in *M. viridis*). It is shortly described by Dewar (*Indian Birds*, p. 161) as “general hue green, shot with bronze; the tail is bluish. There is a broad, black streak running through the eye. The chin is dirty cream colour. The throat is chestnut-red. The eye is bright red.”

The Blue-tailed Bee-eater occurs commonly throughout the Plains of India but is partially migratory, visiting Northern India in the summer and Southern India in the winter. In Bihar they are seen from March to October and in the Duars have only been

¹ *Agric. Journ. of India*, XV, 1.

noticed during June and July. Mr. Stuart Baker only once came across it in North Cachar. Usually it is seen in small numbers or singly in one place but occasionally it congregates in large numbers. As a rule it is commonest in well-wooded districts. It is fond of perching on a post or telegraph wire or other suitable situation whence it swoops down on its prey which is usually captured on the wing, the bird thereafter returning to its perch. The flight is swift and graceful and the note a mellow whistle continually uttered while on the wing. During evenings, especially after rain, numbers may be seen hawking about on the wing for a long period without settling.

This Bee-eater is common at Pusa and the late C. W. Mason examined the stomachs of thirteen birds between April and October. He states¹ that, of 83 insects taken, 70 were beneficial, 3 injurious and 10 neutral. The beneficial insects taken included dragonflies, honey and other bees, and wasps, and in the neighbourhood of an apiary these birds may be a decided pest by snapping up the bees.

Breeding occurs, usually in large colonies, some time between March and June, in a hole which may be four to seven feet long with a diameter of two to two and-a-half inches and which is excavated in a bank, usually a river bank though not always so, the egg-chamber being about half a foot in diameter and, what is unusual with bee-eaters, it is sometimes lined with grass or feathers. Four or five and rarely seven glossy, white, almost globular, eggs are laid. Our Plate shows the entrance of a nest.

Besides the present species there are six others found in India and Burma, viz., the Common Indian Bee-eater (*Merops viridis*), a smallish green bird with a golden hue on the crown of the head and the usual black band under the eye. This is the commonest of all the Bee-eaters and as a rule resident wherever it occurs. We shall probably return to it in a later paper. The Blue-cheeked Bee-eater (*Merops persicus*) is very like the Blue-tailed bird but has the upper surface of the tail green instead of blue. This is a migrant from Africa and West and Central Asia to the North-West of

¹ *Memoirs, Dept. Agriculture, India, Ent. Series, Vol. III, p. 165.*

India, breeding there. The European Bee-eater (*Merops apiaster*), a smaller species with a yellow instead of a chestnut throat, is also a migrant from Africa, visiting Kashmir and the Punjab during May and June. The Chestnut-headed Bee-eater (*Melittophagus swinhoei*) has a short tail and is chestnut above: this species is mostly confined to forests. The Blue-bearded Bee-eater (*Nyctiornis athertoni*) and the Red-bearded Bee-eater (*N. amictus*) are stout birds for Bee-eaters, and have, as can be seen by the names, blue and red plumes down the breast; they are green above; these birds are not so graceful in their movements as the other Bee-eaters. Blanford says the nidification of the latter bird is unknown but since then the eggs have been taken in Perak in February; they appear to be smaller than those of the Blue-bearded species.

INVESTIGATIONS CONCERNING THE PRODUCTION OF INDIAN OPIUM FOR MEDICAL PURPOSES.

BY

H. M. LEAKE, M.A., F.L.S.,

Officiating Director of Agriculture, United Provinces ;

AND

H. E. ANNETT, B.Sc., F.I.C., F.C.S.,

*Agricultural Chemist to Government of Bengal, on special duty in the
United Provinces.*

FROM time to time references have been received from the Opium Department with reference to the supposed increase during recent years in the severity of fungoid attack on the poppy plant. The attack leads to diminished yield and, consequently, to a diminished willingness on the part of the cultivator to grow that crop. It was, therefore, decided to take up the serious study of the poppy plant at Cawnpore. From the mycological aspect the disease had received much attention at the hands of the Mycological Section at Pusa¹. There remained, however, the study of the poppy plant itself. Since a brief investigation of the plant, carried out by the Howards and Abdur Rahman² in 1910, the crop had received no attention from the botanical aspect.

The existence of races resistant to fungoid disease is a well-known phenomenon and the isolation and multiplication of such races has formed a marked feature of the work of many of the American agricultural stations. Biffen's work on wheat is an

¹ *Report of the Agric. Res. Inst., Pusa, 1913-14, 1914-15 and 1915-16.*

² *Memoirs of the Dept. Agric. in India, Bot. Series, Vol. III, No. 6, p. 321.*

example of this class of work carried a stage further. Biffen has succeeded in combining the disease-resistant character of one wheat with economic characters, such as strong straw and 'strength,' exhibited by other classes of wheat, into one individual from which, by multiplication, a seed supply sufficient to sow extended areas has been produced. It seemed more than probable that a similar study of the poppy plant would, in like manner, lead to the discovery and isolation of disease-resistant races from the poppy crop.

It is a recognized fact that field crops, as grown by the cultivator, are, with the rarest exceptions, mixtures. It is almost invariably possible to isolate from a single field a large number of types differing from each other both in structure, in habit and in quality of the produce. There appeared no a priori reason why this should not equally be the case with the poppy crop, and a preliminary examination of the cultivators' fields only strengthened the conviction. In its initial stages, therefore, the investigation was confined to the isolation of as many types as possible from the crop as generally grown, with the object of obtaining, from among these, certain types that showed a natural resistance to the disease responsible for such widespread loss.

In the year 1915, the investigations received a different orientation. In pre-war days the opium produced in the Balkans and Asia Minor, which normally contains 12 to 14 per cent. of morphine, practically held the monopoly of the medical opium market. When Turkey and Bulgaria entered the war against us, supplies of medical opium failed, a failure which synchronized with the time when the demands of ourselves and our allies were greater than ever. Indian opium in the past has been distinguished by its low morphine content, which has been stated to be about 8 per cent. ; and, mainly for this reason, it was not employed for medical purposes in pre-war days. The problem, therefore, of raising the morphine content of Indian opium, which had been put forward at intervals since the early nineties, became acute. There was, moreover, the additional incentive that the trade might be retained permanently after the war.

In the manufacture of opium alkaloids British firms have been able easily to defy competition. At least 90 per cent. of the opium sold for medical purposes is used for the manufacture of alkaloids, and the remainder for druggists' requirements in powders, tinctures and such like. For the former purpose, the manufacturers naturally desire opium of high alkaloidal content. For the latter, there is little market for opium containing less than $9\frac{1}{2}$ per cent. morphine in the dry opium, since the British Pharmacopœia lays down that opium used for pharmaceutical purposes must contain between $9\frac{1}{2}$ and $10\frac{1}{2}$ per cent. of morphine. Opium of higher morphine content than $10\frac{1}{2}$ per cent. may be reduced to the required standard with opium containing less than $9\frac{1}{2}$ per cent. of morphine. The scope of the investigations was, therefore, extended with the object of removing the disabilities under which the Indian produce laboured as a source of opium for medical purposes and the present article summarizes the progress of this aspect of the work.

BOTANICAL.

The general lines along which the botanical investigations have been developed have been already stated. As conceived, it consisted in the isolation of pure races with a view to the introduction of disease-resistant cultures. Subsequently selection was extended to the development of races yielding opium of high morphine content. Further, sight was not lost of the possibility of developing work along the lines so successfully employed by Biffen in the case of wheat.

For the purposes of this investigation large numbers of samples of seed of the poppy were procured and sown in 1914, while cultures have been made of further samples of seed received yearly. The bulk of these samples were obtained from the poppy-growing tracts of the United Provinces but work was not restricted to these. Seed has been procured from such diverse localities as Malwa—the second largest poppy-growing tract of India—the hill districts round Jaunsar, Persia, Egypt, England—the true opium poppy of the Balkans and Asia Minor kindly supplied by Mr. L. Sutton—and Japan.

The pollen of the poppy is light and dry and may be carried long distances by wind. The flower is, moreover, open and freely visited by bees. Cross-fertilization is, therefore, of frequent occurrence ; as many as 25 per cent. of the offspring of a pure type have, in some cases, been identified as crosses. To guard against such contamination of the pure lines protection has to be rigidly carried out in all work on the crop. With suitable precautions, however, the isolation and maintenance of pure races is not a matter that presents any great difficulty.

From the preliminary sowings of the seed so procured a series of single plant cultures were raised which included all the forms recognizably distinct and gave a very fair indication of the differences to be found in the poppy as grown by the cultivator. The preliminary cultures at once indicated the correctness of the supposition as to the mixed nature of the crop. They indicated yet another point frequently met with when the vernacular names of races are considered ; namely, that the name applied to one race in one tract is applied to another race in another tract. To such an extent is this the case with the poppy that different officers of the Opium Department, intimate as is their knowledge of the plant, have frequently, when visiting the experimental fields at Cawnpore, applied different names to the same culture. This is no slight on the officers of that department ; the diversity of name is due to the diversity of the districts in which those officers serve. It emphasizes, however, the unreliability of vernacular names as a guide to accurate work and of the use of such names as a basis for accurate conclusion.

These cultures further indicated, what is also commonly found in such cases, that, while purity is rarely, if ever, found in the field, a fair degree of purity is of common occurrence. Stated in another way, a culture frequently shows a dominant type to which the name used by the cultivator may be presumably applied. A few examples taken from a large number of analyses of preliminary sowings will indicate the degree of reliability that can be placed on the interpretation of vernacular names.

Percentage of different types found in different cultures of the poppy plant.

Variety name				Types					
				1	2	3	4	5	6
1	Bharbharwa	10	20	Few	70
2	Do.	80	Few	20
3	Do.	Few	100
4	Do.	45	45	10
5	Do.	95	5
6	Do.	75	5	20
7	Katela	20	40	Few	40
8	Do.	90	10
9	Do.	10	20	70

In the above table the types are referred to by numbers for the sake of simplicity but type 6 is the typical *Katela* plant. The eighth sample, therefore, contains no *Katela* plants at all though the seed bears that name. A comparison between samples 1 and 9 illustrates a further point. These samples bear different names yet the two are composed of practically identical mixtures.

From the single plant cultures so raised with every precaution against accidental cross-fertilization it has been possible to select out a large number which showed every indication of purity. These cultures, in their turn, have formed, on the one hand, the basis of the chemical work and have provided, on the other, an indication as to the degree of susceptibility of the different types to disease. Differences occur in such morphological characters as leaf shape; colour of stem, green or blackening on ripening (*Kali Danti*); height of stem; shape and colour of petal; shape and surface of the capsule, waxy or shining (*Telia*) and colour of seed; while, in addition to the question of disease, marked differences in the time of maturation and in susceptibility to insolation occur among the physiological differences. Chemical analysis of the opium derived from these pure cultures has indicated that the racial diversity in morphine content is large. Races have been isolated which have as high a morphine content as 20 per cent. while, at the other extreme, are races yielding only 6 per cent. morphine in their opium.

A large proportion of the races yield opium containing more morphine than that required by the British Pharmacopœia standard for medical opium. Selection for vigour and disease-resistance in combination with a high morphine content has not, therefore, been a matter of extreme difficulty. It has, in fact, been possible to isolate suitable races directly and without recourse to synthesis of a plant by the union of characters previously not found in combination. The elimination of this necessity has simplified the problem from the breeder's point of view though the scientific interest attached to the successful union of such intangible characters remains.

CHEMICAL.

The desirability of determining the extent to which the capacity to produce an opium having a high morphine content could be considered a plant character was early evident and the earliest chemical work was devoted, therefore, to the examination of the opium derived from the 500 odd pure races of which the opium had been extracted. The analytical work involved in this work was, naturally, considerable ; but the results shewed that there was a considerable variation in morphine content of the opium of the different races. Reckoned on the dry opium, the morphine content varied from 6·5 to 20·5 per cent. A number of these pure races have been grown in three successive seasons in order to see whether there is any seasonal variation involved. The results of the work are, in this respect, incomplete but, in many cases certainly, a race producing opium of high morphine content has maintained this character. On the other hand, it must be admitted that there are many cases in which opium produced from the same pure race varies considerably in its morphine content in successive years. It must be remembered that purity in this case has been determined on morphological, and certain obvious physiological, characters only. That certain of the races, apparently pure when judged by these standards, should prove to be impure with respect to less obvious characters need not be a matter for surprise ; and the results so far obtained would appear to point to the probability that the production of opium with high or low morphine content is a race character.

Fortunately the first season's work supplied the explanation of the reason why Indian opium was generally found to possess a low morphine content. But before dealing with this it will be convenient to indicate the manner in which opium is obtained from the poppy capsule. About 12 to 18 days after the fall of the petals, the capsule is ready for lancing. The cultivator recognizes the correct stage of ripeness mainly by touch. He uses a knife built up of three or four parallel blades, with sharp points set about 1/16 inch apart. This knife is drawn carefully and vertically over the surface of the capsule while care is taken that the points do not incise too deeply. The incision is made in the early afternoon and early the next morning, after the dew has evaporated, the coagulated latex is collected and stored in earthenware vessels. The capsule is lanced again at successive intervals of three days as long as it will yield latex. At times each capsule will receive as many as eight successive lancements in this manner. The produce of all these lancements has, in the past, been mixed together by the cultivator before the opium is made over to the opium officer.

The produce of each successive lancing has been examined separately for morphine content. The results of this examination proved to be of considerable interest in that they afforded an explanation of the generally low morphine content attributed to Indian opium. The morphine content of the opium was found to diminish rapidly at each successive lancing. The appended figures are typical of the many hundreds of determinations made.

Morphine per cent. in the opium from successive lancements of the same capsules.

Series	No. of lancing				
	1	2	3	4	5
I	14.3	11.3	8.9	5.7	—
II	16.7	14.5	10.5	8.2	—
III	11.5	8.6	5.7	3.5	1.5

The fall in the morphine content of the opium of each successive lancing is striking. Samples of opium from the fifth lancing which

yielded no morphine by the ordinary methods of analysis have been met with.

In Asia Minor and the Balkans each capsule receives only one lancing and herein lies the simple solution of the problem why the produce of this area is so much higher in morphine content than that of Indian opium in the past.

Another very important factor which must be taken into consideration in any work on opium has also been elucidated. It is that the number of capsules borne on a plant influences the morphine content of the opium produced. Thus the opium of the first capsule to appear—the terminal capsule—is much richer in morphine than that from the capsules subsequently formed—the lateral capsules—on the same plant. The following figures, selected at random, from numerous similar sets illustrate this point.

Morphine content of opium of each successive lancing.

Serial No.	Description	No. of lancing				
		1	2	3	4	5
I	Terminal capsules	14.0	8.4	5.3	3.3	—
	Lateral capsules of same plants ..	12.2	7.1	4.9	—	—
II	Terminal capsules	15.7	12.3	7.5	9.4	2.8
	Lateral capsules of same plants ..	8.2	5.0	1.6	1.3	0.0

This line of work obviously indicates that, in order to procure opium of the highest morphine content, it is desirable to develop a race which produces only one capsule per plant. Recognition of this factor is also of much importance in any work on the poppy latex and allowance has been made for it in later work.

The effect of climate on the morphine content of opium has also been investigated. Opium of high morphine content has been produced in all countries, *e.g.*, Sweden, Germany, France, the United States of America, Africa, Egypt, Turkey and Japan. Hence it hardly seemed likely that climate was a ruling factor. In these experiments the same pure race has been grown at various places in the plains and at various altitudes in the hills. These experiments have been continued for three seasons. Stated briefly,

the various conditions under which the plant has been grown have exerted no marked effect on the morphine content of the resulting opium. Sudden changes in weather conditions, however, affect the yield of latex. For instance, east winds and cloudy weather diminish the yield of latex but do not influence its morphine content. A similar effect has been observed by one of the writers (H. E. Annett) in the flow of palm juice.

The effect of various manures has been carefully studied. Of the various mineral manures used at Cawnpore only nitrogenous manures appear to have an appreciable effect. Nitrate of soda increases the yield of latex considerably, in fact almost doubles it ; but the percentage of morphine in the latex is not altered to a significant amount. The effect of nitrate is to increase the size of the capsules and not to increase their number.

It is not possible to enter in detail into the numerous other observations which have been made. The influence of the age of the capsule at the time of lancing has been studied and it has been found that very young capsules, say 5 or 6 days old, produce opium of low morphine content ; but, after this age, the morphine content of the latex is more or less constant, however old the capsules may be. Moreover, the morphine content of the latex diminishes in the later runnings from the same cut surface. The effect of different methods of lancing has also been studied in detail and has led to interesting information relating to latex flow.

In this account attention has so far been directed only to the question of morphine. But accompanying morphine, in opium, are many other alkaloids, chief among which are codeine and narcotine. As the result of new methods of estimation which have been devised in the course of this work, it has been possible to study the behaviour of these also. They do not behave at all in the same way as does morphine. Thus the percentage of codeine appears to remain constant in the opium from each successive lancing of the same capsule. In this connection an interesting problem, which is now forming the subject of investigation, arises as to why Indian opium is so rich in codeine. It contains 2 to 4 per cent. of this alkaloid whereas Turkish opium contains only

small quantities. The high codeine content of Indian opium brings it much into favour with alkaloid manufacturers since codeine is more valuable than morphine.

The whole work has thrown much light on the function of kalaloids in plant life. The animal takes in complex foods and excretes much of its nitrogen in a simple form as urea. The plant, on the other hand, lives on simple substances and builds up complex compounds. It is not surprising, therefore, that its waste nitrogenous substances are complex in structure; and these investigations point to the fact that the alkaloids represent the useless end products of metabolism. In this connection it may be pointed out that the caoutchouc content of rubber latex appears to show phenomena similar to those exhibited by the morphine content of poppy latex. Thus, in successive incisions made in the same plant for rubber, the caoutchouc content appears to diminish in the same manner as the morphine diminished in successive lancements from the same capsule.

CONCLUSION.

For some years past work bearing on this subject has been carried out by the Imperial Institute and the latest account appears in the Bulletin of that Institute for January-March, 1919. The work which is there described is open to criticism on several points and the opportunity now offered of referring to it may be taken.

The figures given earlier in this note with reference to the constitution of the field crop indicate the danger of placing any reliance on vernacular names for the identification of a race. In the case of the poppy this is, as has been said, particularly true. In two cases only, the *Kali Danti* (black-stemmed) and the *Baunia* (dwarf) are the names applied with any certainty, while the name *Katela* is used indifferently for at least two entirely distinct types. It must not be forgotten, further, that the cultivator will apply a name to his crop, however complete the mixture of types he is growing may be. The pure cultures which have been subjected to chemical test and which include every recognizable type of plant, indicate the existence of little or no correlation between the type,

in the morphological sense and as recognized by the cultivator, and the morphine content. The recommendations based on the use of vernacular names and particularly that made on page 11 of the article under reference "that the varieties noted on page 8 and 9 are well worth consideration for cultivation purposes" would appear, therefore, to rest on singularly insecure foundations.

It may, further, be noted that no information is given with regard to the origin of the samples in respect to the lancing from which they were derived. In view of the absence of this record, it must be assumed that this point was not considered and that the history of the samples in this matter was not recorded. It is far from likely that, unless especial precautions were taken, these would all contain yields from the same number of lancements since frequently the capsules dry up after a second lancing in one district, whereas, in a neighbouring district, they may yield as many as five successive lancements. The variations recorded in the course of that paper are now known to be fully within the range given by different lancements of the same plant and may be as readily ascribed to this cause as to racial, or soil, differences. The problem under consideration is, in fact, typically one which can be studied only on the spot.

THE ELEVENTH MEETING OF THE BOARD OF AGRICULTURE IN INDIA.

BY

F. J. F. SHAW, D.Sc., A.R.C.S., F.L.S.,

Second Imperial Mycologist.

THE eleventh meeting of the Board of Agriculture was held at Pusa from 1st to 6th December, 1919, under the presidency of Mr. James Mackenna, Agricultural Adviser to the Government of India. There was an exceptionally large attendance of members and visitors, the latter including, besides the Hon'ble Sir Claude Hill and the Hon'ble Mr. R. A. Mant, Mr. Lewton-Brain, Director of Agriculture, Federated Malay States, and the members of the Indian Sugar Committee.

The first day's proceedings opened with a speech from Mr. Mackenna, in which he made a survey of the more important events affecting the Department of Agriculture during the past two years. Since the last Board, sectional meetings of workers in chemistry, mycology and entomology had been held and had been an unqualified success. Provincial Boards of Agriculture, to meet annually, had been formed in some provinces and it was hoped that, by solving questions of purely local importance, they would materially lighten the labours of the full Board. In conclusion, the President dwelt on the approaching changes in the *personnel* of the Department of Revenue and Agriculture. In Sir Claude Hill the department was losing a head who had ever identified himself absolutely with the interests of the Service, and in Mr. Mant they had always had a sympathetic and helpful Secretary.

On the conclusion of the President's speech, committees were appointed to deal with the various subjects. It is not possible within the limits of a brief article to do adequate justice to the interesting debates and the important resolutions resulting from these discussions. This information will be found in detail in the published proceedings of the Board.

The first two subjects were considered together at a full meeting of the Board and dealt with the danger of the depletion of the nitrogen content in Indian soils by the introduction of high-yielding varieties of crops and intensive cultivation, and the resulting importance of investigations into the conditions of nitrogen fixation in Indian soils. Mr. Hutchinson, who opened the discussion, compared the depletion of the nitrogen reserves in Indian soils to the exhaustion of European coal-fields. In Bihar the cultivator deliberately avoided securing a higher yield by intensive cultivation and aimed at a low average yield which would not deplete the fertility of the soil. The level of this fertility was determined, partly at any rate, by the natural rate of nitrogen fixation, and he would urge upon the Board the desirability of passing a resolution on the necessity of research upon nitrogen fixation in Indian soils. Mr. Burt, while in sympathy with the suggestion for research on nitrogen fixation, thought that there was little evidence of soil exhaustion in the districts with which he was familiar. It was of great importance that improved cultivation and manure should accompany the introduction of improved varieties. The Board finally passed a resolution stating that the time had now come when every province should have its own Agricultural Bacteriologist and that the staff of the Imperial Agricultural Bacteriologist should be strengthened.

The Board then considered the report of the committee on subject (iii), dealing with the export of cattle abroad. The committee stated that they did not consider that any deterioration, to a marked degree, was taking place in Indian cattle or that any such deterioration could be due to export abroad, as this was a negligible feature of the total export. The report was accepted by the Board.

The debate on subject (iv), dealing with agricultural forecasts and statistics, was of great interest. Mr. Noyce, in moving that the report of the committee on this subject be adopted, said that while the figures for crop areas in India were among the most accurate of their kind, the estimates for normal yield and the condition factor were naturally less easily made. Crop-cutting experiments should be used as a check and not as a basis for arriving at the normal yield. He hoped that the time was not far distant when every province would have its own statistical department.

Dr. Gilbert Slater said that he had endeavoured during the sittings of the committee to get a clear idea of the duties which would be imposed on Directors of Agriculture by the adoption of the committee's report. The first duty of each Director would be to secure the appointment in his office of a special assistant for statistical work. Each Director of Agriculture would become engaged in a deadly conflict with a gentleman whom he would call "Mr. X". "Mr. X" is the official who is hidden in the recesses of the Finance Department of the Secretariat of each Government in India, who shroffs all proposals of executive departments before they reach the Hon'ble Member, and who devotes his great industry and persistence to the task of invariably spoiling the ship to save a ha'porth of tar in the name of economy. He knew quite well what was in store for the Director of Agriculture when he endeavoured to act in accordance with the resolutions of the Board. He will ask for a statistical officer, "Mr. X" will at best be willing to concede a clerk on Rs. 25 per mensem. He will ask for a soil bacteriologist, "Mr. X" will try to limit the salary to Rs. 15. For he regards himself as the faithful defender of the poor tax-payer from the wild onslaughts of Directors of Industries and Directors of Agriculture. The whole future of Indian agriculture depended on the winning of victories by the Agricultural Departments over these elusive and anonymous opponents. Members might remember that in England the master stroke of Edwin Chadwick, in his great campaign for public health, was securing in 1837 the complete registration of births and deaths. That was what supplied the lever by which the necessary financial provision was secured for one

measure after another for combating death and disease. Similarly, reliable agricultural statistics would furnish the lever for securing what is financially necessary for agricultural progress and prosperity for India.

Mr. Jacob then explained to the Board how aeroplanes had been used for taking photographs to form a crop survey in Lahore, and the Board passed a resolution that further investigations in the application of aeroplane photography to crop surveys should be carried out.

Mr. Wood said that he considered that the committee had over-emphasized the importance of crop-cutting experiments. Crop-cutting experiments to be of any use must be so numerous as practically to prevent them being carried out by the staff available. He moved that the Board pass a resolution that crop-cutting experiments should be abandoned. This was not carried and the report of the committee, with slight amendments, was adopted by the Board.

The next subject (v) before the Board was whether any special measures are necessary with regard to the introduction of motor ploughs and tractors. In reading the report of the committee on this subject, Mr. McSwiney urged the appointment of a Government Tractor Engineer to safeguard the interests of the buyers, who might otherwise be sold unsuitable machinery by agents who have no knowledge of agriculture. On the motion of the President a resolution was carried to the effect that a section of Agricultural Engineering should be established at Pusa to investigate the use of agricultural power machinery, with special reference to motor ploughs and tractors. The report of the committee was then accepted by the Board.

From this the Board passed on to a consideration of what steps might be taken to encourage the manufacture of improved tillage implements (subject vi). Dr. Coleman, in moving the adoption of the report of the committee, said that research work on this subject was a function of the Agricultural Department, and urged that Agricultural Engineers should be recruited to the Indian Agricultural Service especially for this work. Other speakers suggested that the matter might be left to the enterprise of private firms, but the

sense of the Board was finally expressed in a resolution stating that research work on the lines indicated in the report of the committee was a function of the Agricultural Department, and that Agricultural Engineers should be appointed to the Indian Agricultural Service for this purpose. The Board laid special emphasis on the fact that such engineers must be members of the Indian Agricultural Service and not attached to the Department of Industries.

Sir Claude Hill then addressed the Board as he had to leave Pusa that day. He said that this was, to his great regret, the last occasion on which he would address the Board as Member for Revenue and Agriculture. The Board was to be congratulated on the work which had been got through up to date. He was particularly glad that the Board had passed the resolution on the establishment of an Engineering Section at Pusa and had endorsed the desirability of extending bacteriological work. The Hon'ble Member then dealt with the difficulties which had attended agricultural progress during his years of office. The incidence of war and famine had magnified the tasks of the Agricultural Department and handicapped that development and progress which they all had at heart. Still the previous five years had not been barren, and thanks to the loyal and able support which he had received from all ranks of the various departments of agriculture, much had been achieved. Agricultural education and the problems of cotton and sugar had all been the subject of special enquiries. With regard to the former a stimulus had been given which promised in the near future to revolutionize the older methods of agricultural education, while the success of the Cotton Committee, over which Mr. Mackenna had presided so ably, was evidenced by the appreciation of its report at the hands of the public and the Empire Cotton Growing Association. As they all knew, they were now confronted with far-reaching political changes, but he looked with confidence to the future and the part which the Indian Agricultural Service would play in it.

The Board then proceeded to the discussion of subject (vii), whether the Agricultural Department should undertake the writing

of school readers and story books. Mr. Clouston moved that the report of the committee should be accepted. He thought that in this way much might be done to make the aims and successes of the Agricultural Department more fully appreciated by the people. Dr. Kunjan Pillai and Mr. Dutt both supported Mr. Clouston, and urged that more attention be given to the production of popular bulletins. Dr. Coleman said that the subject of getting in touch with cultivators had been debated *ad nauseam* in the Board for years. It was not a testimony to the intelligence of the Board to ask them to accept this report and he moved its rejection. After some discussion the report of the committee was rejected by the Board but a resolution to the effect that officers of the Agricultural Department, who felt qualified to do so, might attempt literature of the type under discussion was accepted.

The question of allowing village *panchayets* to raise local rates with a view to maintaining roads, drainage and irrigation works (subject viii) was then considered. Mr. Dutt, I.C.S., in moving the adoption of the report of the committee on this subject, explained the advances which had been made on these lines in Western Bengal where the maintenance of irrigation tanks was of great importance and could only be satisfactorily achieved by some system of local co-operation. The report of the committee was accepted by the Board which then passed on to a consideration of the practical methods which might be adopted for the conservation of natural sources of manure, such as bones and oil-cakes, for use in the country (subject ix).

Mr. Wood read the report of the committee and placed four resolutions before the Board. This initiated one of the most interesting of the discussions of the meeting. The question of the advisability of placing an export tax on oil-seeds and cakes showed a sharp division of economic thought among the speakers but was finally agreed upon. A large majority of speakers emphasized the fact that the export of bones and fish manures was a drain on the fertility of the country and the Board finally accepted a resolution that total prohibition of export was necessary. The committee's proposal that a portion of the revenue derived from the

export tax should be earmarked for propaganda work on manures was withdrawn, as the Hon'ble Mr. Mant explained that the proceeds of Customs duties were an Imperial asset and agricultural propaganda under the Reform Scheme would be a charge on Provincial revenue ; obviously Imperial funds could not be earmarked for Provincial expenditure. The Board finally passed a resolution expressing the hope that Local Governments would consider the claims of their Agricultural Departments to increased allotments for propaganda work.

The Board then considered the report of the committee appointed to deal with the duties of the Agricultural Departments under famine conditions and the manner in which the Agricultural Department should prepare to face famine (subject x). The extremely able report of this committee was very lengthy and its adoption was moved by Dr. Mann. The Board accepted, with slight amendments, all the proposals of the committee with reference to well-boring, the surveying of rivers and the erection of embankments to check erosion. Other measures approved by the Board were the transport of cattle by rail from famine tracts to better provisioned districts, investigations into grain storage on a large scale and the collection of statistical information with regard to the main food crops. In the discussion on these matters perhaps the most interesting fact which emerged was the opinion expressed by Dr. Slater that the success of recent famine relief measures had resulted in smaller stocks of grain being held in the country. If grain was not in the country, money was useless. Had, as seemed possible at one time, the 1919 monsoon failed, this situation would have arisen and the problem would have been an international one. The Board recommended the appointment of a strong Famine Commission to consider the problems which would arise by the failure of two successive monsoons. The fact that the duties of the Agricultural Departments under famine conditions had not been clearly defined was also the subject of a resolution.

The report of the committee appointed to review the results of the permanent experimental plots at Pusa and to make proposals for this line of work in the future (subject xi) then came before the

Board. In their report the committee drew attention to the facts that the multifarious duties of the Imperial Agriculturist, and the frequent changes of tenure in that office, had prevented that continuity of supervision which was so essential in field experiments, and the committee therefore recommended the appointment of an Imperial Agronomist, who would supervise the experimental area, to the staff at Pusa. The recommendation of the committee was accepted by the Board.

Lastly, the Board considered the improvement of cotton marketing in India with special reference to the Indian Cotton Committee's Report, paragraph 233 (subject xii). The Board had the advantage at this sitting of the presence of Messrs. Cocolas and Wait, representing the cotton trade. The committee on this subject recommended the establishment, with certain modifications, of markets on the Berar system. The dangers attending co-operative sale societies with a crop the price of which fluctuates as much as that of cotton were felt by the committee to be very great and the committee for this reason rejected recommendation (4), paragraph 233, of the Indian Cotton Committee's Report. On the motion of Mr. Noyce, the Board recommended that the sectional meeting of cotton workers proposed by the committee should take place in Bombay in conjunction with the first meeting of the proposed Central Cotton Committee.

On the conclusion of the formal business before the Board, Dr. Butler addressed the meeting and expressed the regret felt by all members of the Agricultural Departments that they would not again meet under the chairmanship of Mr. Mackenna. Dr. Mann supported Dr. Butler and said that in Mr. Mackenna the Department of Agriculture had always possessed a chief who was in complete sympathy with the work and hopes of all its members. The agreement of the Board with the sentiments expressed by the last two speakers was indicated by the prolonged cheers which greeted Mr. Mackenna when he rose to reply.

Mr. Mackenna said that of all the speeches he had made at the Board of Agriculture this was for him the most difficult and trying. While he could not definitely say that he would be leaving

India for good, he thought it improbable that he would again preside at a meeting of the Board of Agriculture in India, and he felt very much leaving a department with which he had been connected for so long and in which he had made so many intimate personal friends. In point of fact, he would never have accepted the Agricultural Advisership had it not been that he knew that he was personally acceptable to the department and that every member of it would give him every assistance he could to make the tenure of his appointment a success. He had received the most loyal support from every member of the department, and any success which had been achieved was due to them and not to him. As agricultural officers they had a great responsibility. The future of India lay in the development of its agriculture and of its industries, and if these prospered, we would have a happy and contented people. The future of the agriculture of India lay in the hands of those whom he was now addressing, and in wishing them an official good-bye he felt that he was leaving that future in safe hands. He wished them all every success in their careers and would only add that he bade them an official farewell with the deepest personal regret.

This terminated the eleventh meeting of the Board of Agriculture, which, it may confidently be said, will rank as one of the most successful, both from the point of view of work and social recreation, ever held in Pusa. All those members and visitors who were new to the Agricultural Research Institute and Farm took advantage of their visit to inspect the resources and equipment of the laboratories and estate, and the opinion was generally expressed that it would be an advantage if, at future meetings at Pusa, more time could be made available for this purpose.

THE MOTOR TRACTOR IN AGRICULTURE.

SOME IMPRESSIONS OF THE TRACTOR TRIALS HELD AT
LINCOLN IN SEPTEMBER 1919.

BY

T. F. MAIN, B.Sc.,

Deputy Director of Agriculture, Sind.

DURING the last week of September 1919, a great event in the history of agriculture took place at Lincoln. This was the tractor trials organized by the Society of Motor Manufacturers and Traders with the aid of the National Farmers' Union. To find a parallel in its significance to British agriculture one must go back, in the opinion of the writer, to the substitution of horses for oxen or iron for wood. There seems little doubt that the internal combustion engine will, sooner or later, take the foremost place, as a prime mover, in agricultural work both on the land and in the homestead—a position which the steam engine never attained. The paramount necessity for increasing the food supply of the people during the great war was, of course, the immediate cause of bringing the tractor to the front, in Europe at any rate. At first the demand for tractors was met by imports from America, but British firms soon turned their attention to tractor design and construction with the result that wonderful progress has been made during the last two or three years in perfecting this machine. Already large numbers of tractors have been quietly absorbed into British farming, but it required some such exhibition as that held at Lincoln to focus general attention upon this great, new force in agriculture and to mark its initiation into the stock-in-trade of the farmer. It is true that some tractor trials were held in Scotland two years ago, but these appear to have been somewhat

premature, at any rate as regards British makes. The importance which the tractor has suddenly assumed can be gauged from the fact that upwards of forty different makes were exhibited at Lincoln ; most of which were demonstrated on the land. These included every tractor of importance that is on the British market, including a large number of American makes and one Italian machine. The exhibition extended over a week but the first two days were reserved for the judges. The ploughing trials extended over three days, during which time some five hundred acres of stubble and lea were ploughed up : there were also threshing and hauling tests, while one afternoon was devoted to secondary operations on the land such as harrowing. These trials took place in some twenty-six fields spread over several square miles, and visitors from all parts of the country were present in large numbers.

The object of the Lincoln trials was not to convince the farmer of the utility of the tractor—that was assumed—but to assist him in the selection of the tractor best suited to his particular farm and needs. The National Farmers' Union appointed six eminent gentlemen—members of the Council of the Union and all successful practical farmers—to judge the trials, and they were assisted in technical engineering matters by a prominent consulting engineer who specializes in tractor design. These gentlemen will issue a full official report upon the trials, and it is not intended in this note to anticipate that report but merely to record some impressions of the writer who was fortunate in being present on three days.

A few general facts and figures may, however, be mentioned to indicate the broad features of the tractors. First, as regards power, the machines varied from 20 to 40 h.p., but the majority were below 30 h.p. ; the four-cylinder engine predominated and the fuel used in the majority of machines was petrol or benzol, but some paraffin machines were shown. Machines were fitted with two to three forward speeds (in one case nine) and one reverse ; the forward speeds ranged from two to five miles per hour. The lightest tractor present weighed about one and a quarter tons (ready for work on land) and the heaviest about five tons. The

four-wheeled machines predominated, but there were a few three-wheeled machines, and there were three or four caterpillar machines ; there were also a few self-contained motor ploughs. The enclosed spur wheel and worm wheel were the common forms of drive, but there were a few chain-driven machines. Prices ranged from £ 280 to £ 650. The plough associated with these tractors was the two to three-furrow self-lift type, costing from £40 to £60. Cultivators and harrows had a spread of seven to eight feet. In the majority of cases when ploughing, only one attendant was required ; this man sat on the tractor and operated the ploughs by means of levers—a trip arrangement causing the ploughs to enter or leave the land.

IMPRESSIONS.

1. The first impression to record is that the tractor has come to stay, and will play a part in the field comparable to that played by the motor car on the road.

2. The excellent performance of the tractors, taken as a whole, was remarkable ; it was the exception to see a machine in difficulties : practically all appeared to be well above the work they were called upon to perform.

3. The speed at which the work was done was an impressive feature. This exceeded five miles per hour in some cases, whereas horses travel at less than half that rate. This speed was well maintained in secondary operations over soft, loose soil.

4. The space allotted for turning was considerable, perhaps 25 feet, but the smaller tractors did not require so much room—they were, in fact, shorter than horses, and could probably be turned in less space and with greater ease than a pair of horses.

5. The small tractors in particular appeared to be very easy to manœuvre, and would go anywhere.

6. For secondary operations, such as harrowing, the light tractors appeared to hold a distinct advantage as the wheel tracks left by the heavier machines could be seen in well-defined depressions, but both types were quite capable of crossing soft soil without getting their wheels buried ; this was due to the width of the wheel and the well-designed wheel attachments.

7. The tractors were well designed in point of steadiness over rough or uneven ground, showing no tendency to upset when one wheel became raised many inches above the other.

8. The wheel machines seemed to appeal more strongly to the spectators than did the caterpillar types, as the moving parts of the latter appeared to be too numerous and too congested, and, therefore, likely to suffer severely in wear and tear and to get out of adjustment readily. At the same time, the writer was very much impressed with the behaviour of one of these caterpillar machines; it moved rapidly, turned quickly in a small space and appeared to be particularly well balanced (longitudinally), which character enabled it to draw a disc-harrow over ploughed land in a very attractive manner, passing over furrows with ease and rising to ridges as a boat breasts waves. The self-contained motor plough did not impress one favourably, as it appeared too complicated.

9. The tractor, with its relatively great speed, its power to draw gang ploughs and its capacity to work long hours, must be invaluable in periods of great pressure when, for example, a favourable opportunity for sowing may last a day or two and not recur for weeks.

10. In view of the large number of tractors on the market it is obvious that design has not yet reached finality; it is highly probable that numbers will disappear and that those that survive will be modified and reduced to a few more or less uniform types; as regards the best makes, these changes will not, perhaps, be fundamental but only in the direction of greater efficiency, but the adoption of liquid fuel will probably come in time.

THE LESSON FOR INDIA.

As stated in the preceding paragraph, the last thing in tractors is not yet on the market, but there are already machines of great efficiency. The tractor is even now a rival of the horse and will be the main factor in maintaining a high area of tillage in British farming. In India there is undoubtedly scope for the tractor, but before it can be taken up on a practical scale it will be necessary for the Agricultural Department to solve certain preliminary problems.

These are: (1) to carry out exhaustive trials with a number of selected existing makes in order to ascertain the most suitable machines for different conditions, and (2) to devise some scheme whereby a class of competent tractor drivers can be evolved. The Lincoln trials were not sufficiently severe from an Indian point of view. At Lincoln the soil was in ideal condition, possessing just the right amount of moisture so that the ploughs cut through it as a knife passes through butter. It is quite possible that some of the tractors which did well at Lincoln would fail under Indian conditions. There is, moreover, a much greater range of conditions in India than in England. It is necessary to ascertain the best tractors, on the one hand, to work in the dry season on heavy black cotton soil, and, on the other hand, to work in association with irrigation in the Indo-Gangetic plain, to mention only two conditions. Such trials must obviously precede useful suggestions for modifications in design to suit particular Indian conditions.

It has been the common experience of all agricultural officers concerned with district work in India that the greatest impediment in the way of improved tillage was the weak condition of the cattle; this is always the stumbling block when improved methods are attempted. The tractor points to a solution of this difficulty, though the scale of application may be limited for many years.

There seemed to be two circumstances in which the tractor would prove of especial value in India: (1) to assist a devastated famine tract, where the cattle have died, to recover rapidly and at the first opportunity, *e.g.*, tractors equipped with grubbers and drilling machines would enable large areas to be promptly sown with some cereal such as *bajri* (*Pennisetum typhoideum*); and (2) to enable tracts opened up by new canals to be rapidly developed: it is usual when a new canal is opened for several years to pass by before the existing population can adjust its resources and organization to the new conditions. More cattle have to be found and more labour obtained. Even where colonists are imported, it takes several years to develop the tract.

These considerations bring home the fact that the Agricultural Department could hardly perform a more useful function than thoroughly to investigate the possibility of the tractor in India. The great fault with agriculture in this country is the low yield per unit of area, and this is due, in very large measure, to the low standard of tillage farming: the land is seldom clean and the soil not sufficiently worked in many areas. If these defects could be removed, the first step would be taken towards an improved level of yields, and other steps, such as providing an adequate manure supply, would be simplified. A lakh or two of rupees expended upon this problem would be money well invested.

NOTES ON THE PROGRESS OF THE EUROPEAN OLIVE AT PESHAWAR.

BY

W. ROBERTSON BROWN,

Agricultural Officer, North-West Frontier Province.

AFTER many years of almost unrestricted grazing and felling, the wild olive (*Olea cuspidata*) is still common on the Himalayan foot-hills, and slopes abound on the North-West Frontier that would soon be clad with the tree if a period of protection were given. Cherat is a good example of a protected tree-clad hill. As the crow flies, it is situated about 15 miles from the Peshawar Agricultural Station, and it rises, a mass of rocks, to a height of about 4,000 feet. Outwardly it appears destitute of soil, yet, in striking contrast to the bare hills around, its steep sides are densely covered with coppiced olives, almost to the exclusion of any other tree. Along its crest, contingents of the Peshawar Brigade in turn wearily spend the long summer days. Cherat hill is cool and tolerable in the evening only : by day it is made green and habitable by the olives that shelter the bungalows and the winding hill paths.

And each succeeding year, it would appear, the idea occurs to some marooned officer, as he walks forth after sundown, that the olive of commerce would surely be successful where the wild olive grows so well. Almost every year the suggestion is made by someone to the Agricultural Department that the European olive should be introduced to the North-West Frontier hills. The same thought occurred to the writer as he viewed Cherat in 1910, and in the spring of the following year 100 European olive plants were imported from Naples for trial at Tarnab. The plants arrived in excellent condition. The season, was, however, too far advanced to get the trees established before the burning hot June days set in. They were therefore planted at 15 feet apart that

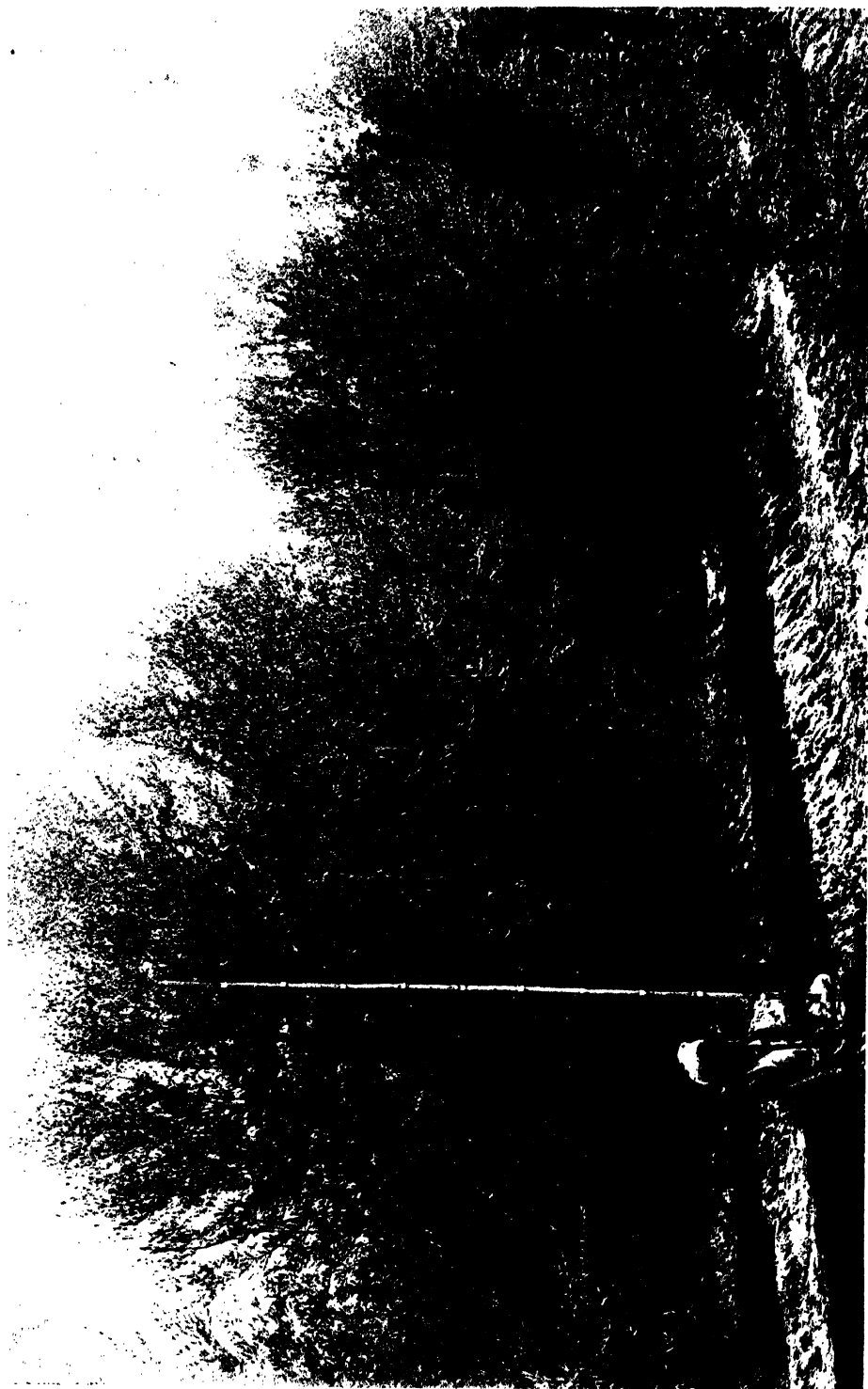

EUROPEAN OLIVE TREES, SIX YEARS OLD, BEFORE THEY WERE TRANSPLANTED.

they might be closely observed and, if necessary, protected. The intention was to transplant two-thirds of the trees in the following spring. But for several reasons, chief among which was the fear that the plants might not transplant successfully, they were allowed to remain as they were—to provide nursery stock. But they grew so vigorously that they threatened to form a thicket which would neither yield propagating wood nor fruit (Plate VIII). It was, therefore, decided to carry out the original idea—to move two-thirds of the trees. This work was started in 1918, when the trees were nearly seven years of age and after most of them had borne from 5 to 20 pounds of fruit.

They were transplanted without soil balls, but were most carefully dug out and set in their new positions. The root-spread



Heads of transplanted olive tree cut back.

of each tree was restricted to 6 feet diameter, and it may be mentioned that, contrary to expectations, all the root systems were extraordinarily shallow. The roots were almost as abundant as fibrous and close to the surface as those of healthy peach trees. No tree had a tap-root. No doubt this was due in a measure to the irrigation which the grove received. The heads of the transplanted trees were cut back in a manner which is very well shown in the figure above. After the soil was settled about the roots by liberal flooding the trunks and branches were wrapped in dry sugarcane leaves to protect them from the sun and, possibly, from frost. Most of the trees were transplanted in January and February, and soon it was apparent that those that were moved first grew more vigorously than those that were transplanted later. By the end of March the branches bristled with plump green buds, which quickly extended and became vigorous limbs. Now, a year later, the olives have big healthy green heads. The trees promise to catch up those that were not transplanted. *It has been determined that established olive trees, full seven years of age, 15 feet in height with 12 feet spread, can be safely transplanted without soil balls.*

Regarding the potentialities of trade in olive products in the North-West Frontier, thus far the trial at Tarnab has shown that the foreign species grows and bears well and early under irrigation, despite the very high temperature and scanty rainfall. At five years of age several of the Tarnab trees yielded up to 20 pounds of plump, well-developed olives, and now, at eight years of age, many of the trees are bearing from 100 to 120 pounds of good fruit.

The percentage of oil from young trees is said to be low, and analyses of the Tarnab fruits proved that they were not exceptional.

There is one ominous danger that clouds the prospects of a trade in olive products on the North-West Frontier hills. In 1916 it was discovered that a destructive olive fruitfly (*Dacus oleæ*) is abundantly present in Himalayan olives. The pest may be expected to attack European olives if they are established on the Frontier. The story of the discovery of the fly is interesting and it may be told. An Italian entomologist desired to know if the

Himalayan olive was attacked by the olive fruitfly that is so well known in Europe and, if so, whether the fly had a parasite. The hope of the scientist was that a parasite might be found in India which could be introduced to combat the olive fly in Italy. Accompanied by the writer, the Imperial Entomologist visited the Cherat hill in 1916 to search for the fly and, perchance, to find its parasite. Almost before baggage was unpacked, the Imperial Entomologist found an olive which contained a maggot suspiciously like that of a small fruitfly. A quantity of wild olives was collected and conveyed to Tarnab. There, before many days passed, a large number of fruitflies emerged from the olives. Happily, many olive fruitfly parasites simultaneously came forth. *The high hope that India might grow olives unchecked by the fly was cast down.* But a cheerful wit has said: "I have had many troubles most of which never came off." Perhaps the fly which afflicts the Himalayan olive will not prove destructive to the European one. Or the olive fruitfly parasite on the Himalayas may be a vigorous one well able to control the olive fly. At the worst, there remains the assurance that this pest on olives is in a measure controlled in Europe by pruning and careful cultivation. Now that the Tarnab trees have attained bearing age, hopes and fears regarding the fly and its parasite should soon be set at rest.

During the progress of the olives at Tarnab it was observed that some sour oranges near the grove were constantly yellow and unhealthy, whilst oranges slightly more distant from the olives were dark green and vigorous. It appears that the orange cannot be successfully interplanted with the olive. This is somewhat of a disappointment at Tarnab where it was intended to try this combination, because, wherever the orange is grown in North-West India, many fruits on the south-west side of the trees are "sun scorched" and spoiled. It was hoped that the olive, whilst yielding a profitable crop, might protect the orange fruits from the sun.

This autumn one or more of the Tarnab olives, which are now fruiting so well, will be selected for propagation and distribution to the hills. But a number of years must elapse before olive oil from the Afghan hills is on the market.

THE DEVELOPMENT OF CANE PLANTING BY THE EAST INDIA DISTILLERIES AND SUGAR FACTORIES, LTD.

BY

MESSRS. PARRY & CO.

(Managing Agents.)

THE East India Distilleries and Sugar Factories, Ltd., may be said to be the pioneers of the cane sugar industry in the Madras Presidency and some brief account of their progress and experience is worthy of record, explaining as it does some of the reasons why central cane factories in India are not always successful, and showing in a general way some of the difficulties to be expected when cultivating cane on a large scale.

A successful cane sugar industry requires large tracts of land within easy reach of a central factory, it being of first importance that cane once cut should pass through the mills within 24 hours of harvesting.

The first problem therefore was to procure suitable lands adjacent to the Nellikuppam Factory and, following on that, sufficient labour to cultivate them.

Here was presented an initial difficulty which at one time seemed insurmountable. For many years the local ryots had grown cane which they brought to the factory to be crushed; but this could never be relied upon as a regular source of supply for the reason that cane was only cultivated when it suited the ryot, *i.e.*, when the price of paddy and other crops offered less inducement than the price which the company could afford to pay for cane.

It was felt that development must lie in the direction of cane farms belonging to the company, but this was apparently an impossible proposition in view of the very high rents required for what are known as "wet" lands upon which only, it was believed, cane could be satisfactorily cultivated.

The very low price of sugar on account of cheap imports from Java and elsewhere made rigid economy a necessity, whilst the question of obtaining sufficient labour to cultivate the land was a further obstacle.

The introduction of the oil-engine for pumping purposes was the beginning of a new era, suggesting as it did the possibility of irrigating the large tracts of "dry" lands in the neighbourhood of the factory which had hitherto proved a comparatively poor source of income to the landowners. In the course of several years' experiments, certain tracts of these "dry" lands were found suitable for the cultivation of cane, and the company commenced to negotiate for leases with a view to expansion to the extent of the labour available.

Such negotiations were at first lengthy and arduous, but some 40 acres were eventually planted, and the problem of procuring a variety of cane suited to the extremely trying Indian climate next presented itself.

It was necessary to find a cane capable of withstanding the hot weather and dry winds of May and June, and equally capable of developing sufficient strength to stand up against the heavy downfall of rain generally experienced between October and December.

With the assistance of the Government Cane Breeding Station at Coimbatore many varieties were experimented with and it was eventually found that the Ashy and Red Mauritius canes would grow more or less satisfactorily, though the yield in tons per acre left very much to be desired in comparison with the crops grown in other countries.

It will thus be seen how handicapped the company was at the start. Land was difficult to obtain, labour at the time of cultivation comparatively non-existent, and suitable canes had to be discovered, the growth of which owing to climatic conditions was only about half

the tonnage per acre accepted as necessary for economical development on a commercial scale.

However, having satisfied themselves that by patient negotiation land was procurable, the company's attention next turned to the question of seasoned canes, irrigation and artificial manuring. The sinking of wells and establishment of pumping stations were easy matters; and judicious manuring demonstrated that reasonably satisfactory crops could be produced if experienced attention was given to the selection of seedlings.

To arrive at this point required much patient investigation, and having surmounted to a great extent the initial difficulties the labour problem had to be considered.

There is plenty of labour to be obtained in the district but as the preparation of land must take place simultaneously with the harvesting of the groundnut crop—more easy and congenial work—some method of mechanical cultivation was essential. To deal mechanically with small plots of "wet" land surrounded with bunds and irrigation channels was not practicable, but having proved that cane could be grown on the large tracts of "dry" land, a Fowler's double engine steam tackle was purchased for ploughing, trenching and cultivating (Plate IX).

This after a year's experience proved a decided success, doing better, quicker and cheaper work on a large scale than had formerly been possible by hand labour even on a very small scale under constant and thorough supervision.

The company was now in a position to go ahead with development and commenced to extend their operations to the limit of their powers of mechanical cultivation, *i.e.*, 7/800 acres.

With this extension the improvement and capacity of the factory mills became essential, and the general activity shown in all directions brought the ryots to realize that the cultivation of cane for the central factory was a steady source of income worthy of attention.

Encouragement to extend the acreage planted by ryots was given in the shape of advances and seedlings, whilst much was done to assist them by the sale of oil-engines and pumps on easy payment.

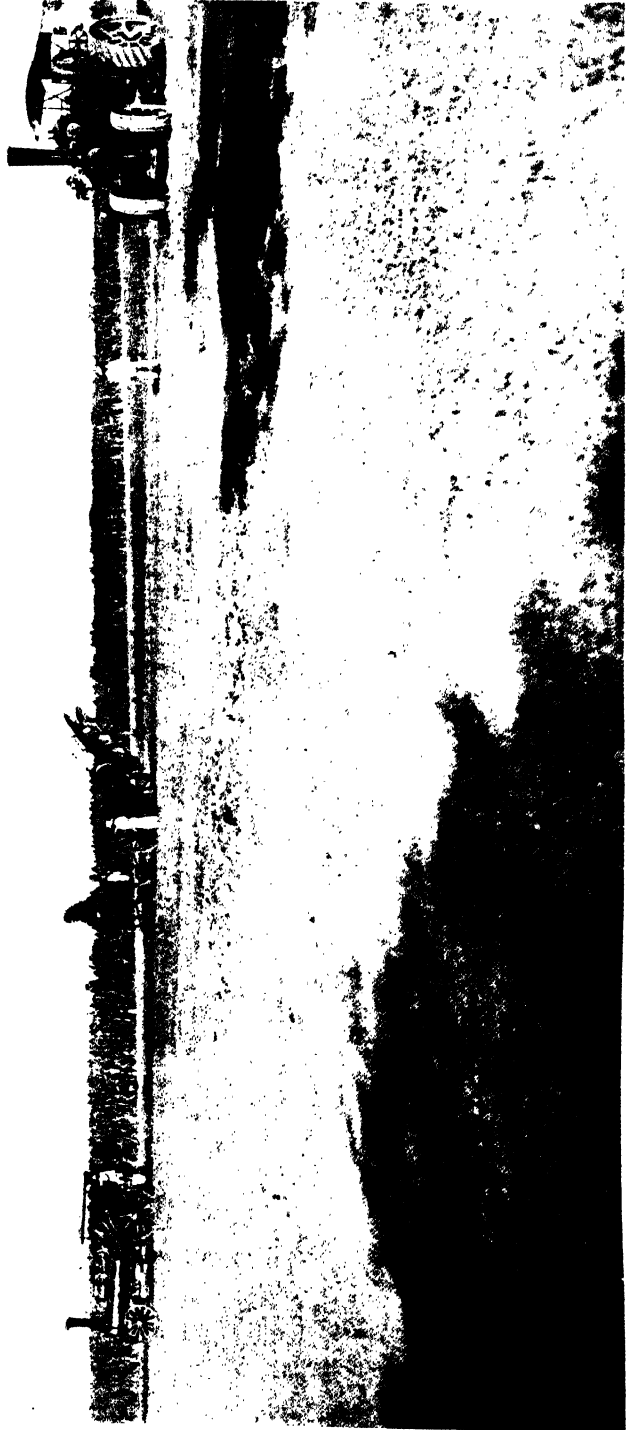

STE. OUGH AT WORK ON DRY LAND.

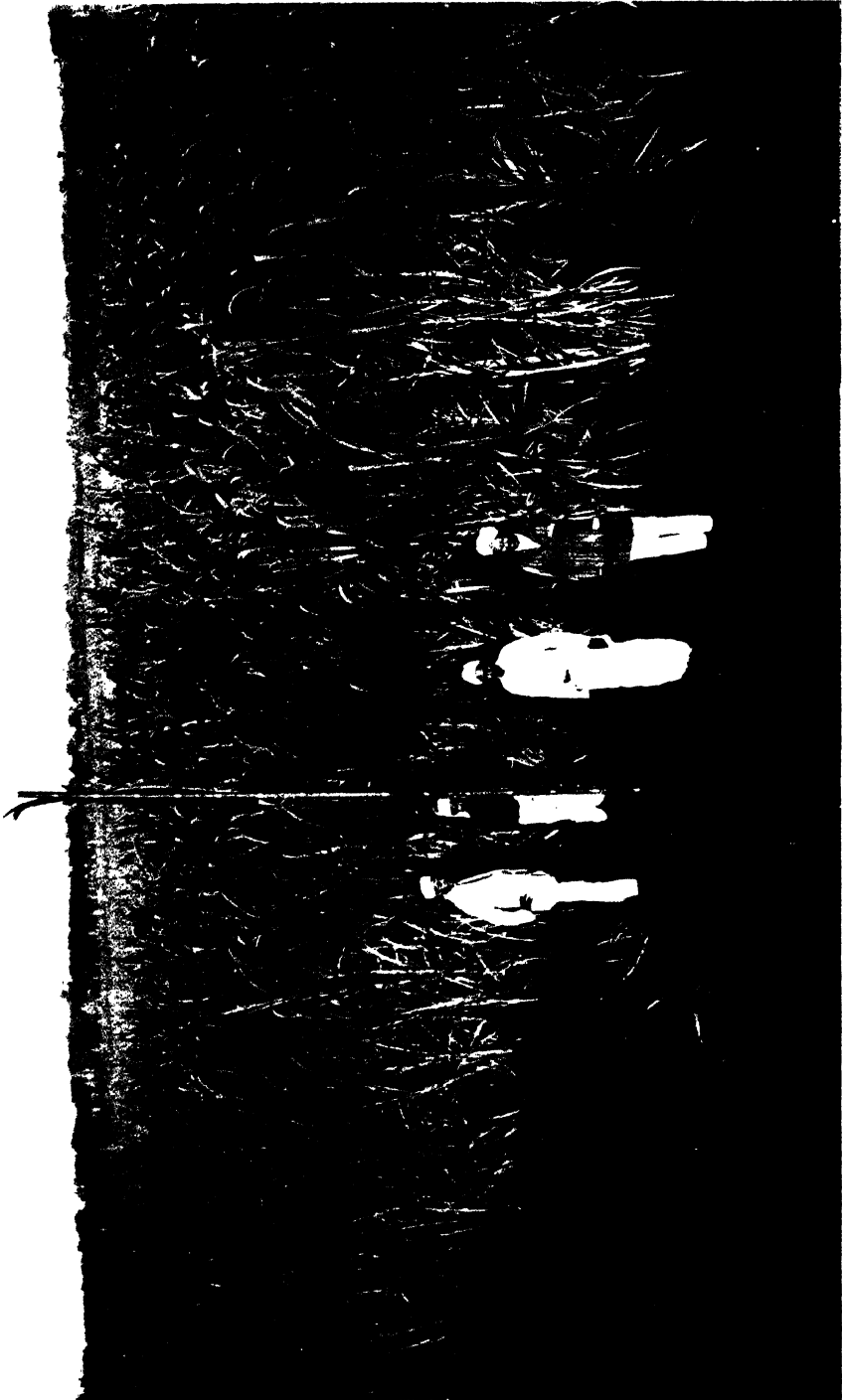

NEI KUPPAM CANE FIE

terms. As a result, the acreage under cane extended very nearly to the limit of the factory's capacity and the question of transport at harvest time became a problem.

Carts had hitherto been obtainable for the company's crops but were now to a great extent requisitioned by the ryots themselves. In addition, it was found that to convey loaded carts of cane across trrenched fields to the roads was a tedious business and heart-breaking to cattle. The company therefore laid down a light portable tramway across their larger farms, with trucks which could be easily propelled by hand labour. This tramway brings the cane to a point on the main road where bandies can be loaded for a comparatively short journey to the factory, and it is intended later to carry the line up to the South Indian Railway and despatch the cane on special trains, thus releasing more carts for work in other directions.

During all the above operations the company was endeavouring to secure a cane of better class than the Red Mauritius variety which, while appearing to be immune from any serious disease, is not of a very high sugar content.

The following table gives particulars of various canes experimented with, and it will be noticed that the most promising of all is Fiji B:—

<i>Name of varieties</i>	<i>% Brix</i>	<i>Purity</i>	<i>Tons of cane per acre</i>
Fiji B.	16.76	83.01	47.78
Kallakurichi	12.46	56.80	42.85
Big Tanna	15.97	78.89	40.96
D. 131	15.77	77.43	37.94
Purple Mauritius	15.50	79.49	37.55
131	14.72	70.28	37.51
Ashy Mauritius	16.71	84.55	36.64
55	15.18	75.72	36.07
B. 3412	17.08	79.77	34.31
D. 74	14.86	77.05	34.01
B. 147	16.01	81.27	32.00
D. 625	15.45	75.41	28.40
Ashy Mauritius	16.78	82.88	25.89
Red Mauritius	16.98	79.57	22.97
Java 247	14.46	76.54	22.60
Ashy Mauritius	15.31	76.35	20.86
Java 247	14.70	73.28	20.24

It must, however, be recollected that the very good results shown have been obtained on specially selected experimental plots,

and that on an average nothing like the tonnage indicated can as yet be expected.

Up to date the average figure has been about 25 tons per acre but by careful manuring it is hoped to bring the figure to 30 tons, which is probably the limit to be obtained in the Madras climate.

This figure is naturally dependent on the rainfall, and the crops harvested in 1919 owing to continued drought during the preceding year were very much below the tonnage hitherto experienced. As a result, the planting by ryots this year has shown a considerable falling off and the company therefore now proposes to make arrangements to increase its own farm acreage to make itself less dependent than hitherto on supplies from outside sources.

We give below some notes supplied by the Manager of the Nellikuppam Factory which are of interest :—

“ I am of the opinion that cane Fiji B, a few sets of which we got from Coimbatore about 4 or 5 years ago, and the area of which we have gradually extended, is likely to prove a much more useful cane than Red Mauritius. It is a short, thick cane of very erect growth and not liable to be blown over by high winds. It has a comparatively high sugar content and crushes splendidly in the mills. The rind is sufficiently hard to defend it from jackal attacks, and during the four or five years we have grown it, although it has been tried under all sorts of varied conditions, it has shown no signs of disease but on the contrary has distinctly improved in appearance and growth. I think the fact that the local ryots have taken spontaneously to this cane as they never did to any other variety, argues well for its popularity and success in the future.

“ With the irrigation facilities we have, our canes generally start very well indeed and give a good and regular stand and very few blanks have to be filled up, although we maintain small nurseries for this purpose. I have shown our young plantations about a month or two old to experienced planters from Mauritius and they seem to think that our canes make a much better and quicker start than they do in that island. Unfortunately, on occasions we have long spells of very dry weather accompanied by hot winds. During such times, even with ample well irrigation, the cane does

not appear to grow at all, and I consider this climatic difficulty is a very serious one and accounts to a great extent for the lower yields obtained in India than in countries favoured with a more humid climate. Further, we have a period in November and December of excessively heavy rain, amounting sometimes to 35 inches in a month, which also does damage to the crop by laying it. The juice of such cane has always a very low purity but no practical means has been found of obviating this difficulty. The introduction of a shorter and thicker cane is the only way we see out of it."

DEVELOPMENT OF IRRIGATION FROM BHIND CANAL: A PLEA FOR ECONOMICAL USE OF WATER.

BY

S. K. GURTU, M.A., M.I.C.E.,

Member, Board of Revenue, for Irrigation, Gwalior State.

IN reviewing the proposals for the Bhind Canal, Gwalior, in 1910, Mr. Preston, after going into detailed calculations in regard to storage and loss in reservoirs and canals, arrived at a net volume of 2,697 million cubic feet on the fields, and assuming the total depth of watering a little over 12" (which meant three to four waterings on the fields) estimated irrigating 110,000 *bighas*. He also considered the possibility of irrigating 200,000 *bighas* with 18" watering in good years. These were theoretical figures estimated before the development of the canal began.

Since 1910, there have been several changes in the lakes. The maximum and average storages of the four lakes now are 10,400 and 6,100 million cubic feet, respectively. These will be subjected to three deductions to get the net volume on the fields:—

1. Evaporation and absorption.
2. Loss in river bed in transit.
3. Loss in canal bed in transit.

After deducting the losses, the net quantities on the fields under maximum and average conditions are 6,010 and 3,040 million cubic feet, respectively.

Originally it was assumed that there would be no loss in the bed of the rivers by water travelling from Tigra and Pagara to Kotwal and Pillowa pick-up weirs, but it has several times been observed that a discharge of 500 cusecs from the higher lakes has

only given a discharge of 400 cusecs at the canal off-take. The loss in the river channels has therefore been assumed to be 20 per cent.

According to the duty which is assumed in projects for net storages, the maximum and average quantities would suffice to irrigate $6,010 \times 30 = 180,300$ *bighas* and $3,040 \times 30 = 91,200$ *bighas*, respectively. These figures are about the same as assumed by Mr. Preston.

The development of the Bhind Canal began in the winter of 1914; we have had five irrigation seasons. It will not be devoid of interest to examine the duties obtained in these years.

1. IRRIGATION SEASON OF 1914-15.

In the first year most of the canals were unfinished and beds not properly cleared. We irrigated an area of about 25,000 *bighas*. No records were, I regret, kept about the storage, etc.

2. IRRIGATION SEASON OF 1915-16.

During this year the net volume on the fields was 2,120 million cubic feet, whereas the irrigated area was 70,000 *bighas*. The crops irrigated were gram and wheat in the proportion roughly of 1 to 3, and the number of waterings varied in different portions of the irrigated tract. In the Tehsils near the head-works, from three to four waterings were given, including the first "paleo" watering (*i.e.*, watering necessary to moisten the fields for sowing). In the tail portion, the number varied from one to two. The total area was, however, small. The average duty* obtained in this year was 33 *bighas* per million cubic feet.

3. IRRIGATION SEASON OF 1916-17.

In this year the rainfall was abnormal. Indeed it beat the record. There was little demand for irrigation. The total irrigated area was 37,400 *bighas*, against the utilized quantity of 1,200 million

* In hydraulic engineering duty means the area which a given quantity of water can irrigate in a season or a year.

cubic feet. This gives a duty of 31 *bighas* per million cubic feet. The loss in the water-courses in this and in the previous year was rather high, as it was not considered expedient, in introducing irrigation in a tract where it was unknown before, to insist on a proper construction and maintenance of water-courses, as that would have scared the irrigators. With better water-courses and stricter supervision, the duty is increasing.

4. IRRIGATION SEASON OF 1917-18.

This year also was a wet year. The Sank-Asan system suffered a grievous loss in the failure of the Tigra dam, by which we lost a storage of about 5,000 million cubic feet, and consequent on damage to Pillowa, which is situated below the Tigra reservoir, the storages of Kotwal and Pillowa lakes also were lost. Thus the entire irrigation (50,000 *bighas*) was done by the storage of Pagara lake. The repairs of Pillowa could only be completed by the end of December and though the cultivators were given hopes of water they were distinctly led to understand that none could be made available before January. Thus when actual irrigation began in this year there was keen demand for water and the number of waterings did not exceed two, and in 50 per cent. of fields was only one. The quantity consumed was 1,680 million cubic feet which, on an irrigated area of 50,000 *bighas*, gives a duty of 30 *bighas* per million cubic feet.

5. IRRIGATION SEASON OF 1918-19.

This year was a year of extreme drought and from the very beginning every body concerned was given to understand that no waste would be permitted and the minimum number of waterings required would be given. In addition to this, a very strict supervision was kept on the use of water and the department set its face against giving water to the tail portion, as it was seen that it would be better to irrigate the maximum area possible nearer the head-works to obviate loss by absorption, instead of supplying inadequate water to the tail portion. The staff was explicitly ordered not to extend irrigation beyond the irrigation capacity of the storage and

to reserve sufficient quantity for a second watering where needed. The number of waterings also was restricted to two. In a very small portion three waterings were given and in an equally small portion one watering was necessary to save the *kharif* crops. Thus, this year may be considered to be the first year of comparatively economical use of water. The sympathies and co-operation of the irrigators were enlisted by assigning quantities of water at different out-lets and appointing *chowdharies* for equitable and economical distribution among themselves, and very severe notice was taken of any wastage, a special staff being deputed for the purpose, in addition to the regular revenue staff. These measures reflected themselves in the high duty obtained. The net quantity used on the fields works out, for this year, to 1,540 million cubic feet and the area irrigated was 60,000 *bighas*. This gives a duty of about 40 *bighas* per million cubic feet, which is very good and clearly shows that, by the introduction of economical methods of distribution, a much higher duty can be obtained.

The experiments of Lawes and Gilbert show that pulses take 10,000 cubic feet of water for actual transpiration; but some waste is incidental in application as, the crops being embedded in loose soil, the subsoil absorbs a great deal of water while the plant is growing.

If we allow 5,000 cubic feet for this, the quantity per *bigha*, under scientifically rigorous conditions of application, comes to about 15,000 cubic feet. The theoretical duty of 30 *bighas* per million cubic feet gives 33,000 cubic feet per *bigha*. From this it will be seen that by the introduction of economical methods of application it is possible to raise the duty per million from 30 to 70 *bighas* for crops requiring two to three waterings. If we follow the advice of Mr. Howard of Pusa and raise wheat, gram and cotton on one watering, it is quite possible to attain a duty of over 150 *bighas* per million cubic feet. The importance of introducing economical methods of irrigation is evident from this. The only way to ensure this is to introduce the system of charging by measurement. The present system is to charge by cropped area, irrespective of the quantity of water used. If the crop is in a flourishing condition,

it is assumed that adequate water must have been allowed and full rate is charged. If a twelve or eight-anna crop is produced, the water rate is reduced proportionately on the assumption that adequate water was not supplied. Nothing, in some cases, is farther from actual fact. Wherever inferior crops result, they are due to any one of the following reasons, singly or in combination :—

1. Copious use of water.
2. Want of aeration of roots.
3. Want of weeding.
4. Situation. Low depression, where water accumulates and prevents soil ventilation.
5. Poverty of soil and absence of manuring.
6. Untimely application of water. Application of water is necessary when the plant is thirsty. The Gwalior irrigator, acting on the principle of "take when you can and not when you may," always gives an early, unnecessary, and abundant watering. It prevents the roots of plants getting oxygen and acts as a toxin.

The Irrigation Department has often to remit watercess for fields which have consumed double the quantity of water supplied ordinarily to an equal area producing normal crops! Is this not setting a premium on wastage? The charge by measurement will obviate this. If we supply a given quantity of water at the out-let for so many rupees per million cubic feet, it will be in the interest of the irrigator to make *kiares* and use water as economically as in the case of wells. When the purse of the irrigator is touched, he responds with alacrity to wholesome stimuli. It is rather early to introduce sale of water by measurement in Gwalior, as elsewhere in India, but I desire to bring the subject prominently to the notice of the revenue and agricultural officers, with a view to enlist their sympathies to facilitate its adoption as early as possible. I commend for their careful consideration the lessons brought out by Mr. Howard in the Pusa Bulletins Nos. 52 and 61. I have put in the thin end of the wedge by charging eight annas for one watering, even in case of a sixteen-anna crop, to enable

the irrigator to realize that he pays only 33 per cent. of the full rate R. 1-8 if he gives one watering instead of two, three or four. A motive is thus supplied for economy. When this begins to work well and the State Agricultural Department establishes by demonstration that wheat and pulses can be raised on one watering, provided soil aeration and root ventilation is ensured, it will be time to drive in the wedge deeper and to introduce the system of charging by measurement.

THE DRYING OF BANANAS.

BY

W. BURNS, D.Sc.,

Economic Botanist, Bombay ;

AND

P. G. JOSHI,

Superintendent, Ganeshkhind Botanical Garden, Kirkee.

IN the "Agricultural Journal of India" for July 1911, there appeared an article by L. B. Kulkarni, L.A.G. (a colleague of the present writers), on *The Drying of Plantains at Agashe*. Since that date and especially during the war, when the food question was urgent, experiments have been made by us in the drying of bananas to determine (1) whether varieties of bananas other than the one used at Agashe could be dried, (2) to see whether there were any reasons why bananas should not be dried at other places than Agashe, and (3) to devise and to develop a cheap and efficient means of drying bananas on a large scale.

In this article the word "banana" is used for any fruit of the plant *Musa sapientum* (or *Musa paradisiaca*). The distinction of the fruits into bananas and plantains has always seemed to us vague and confusing.

Banana-drying is an art of some antiquity. Fawcett¹ gives several references from the works of early travellers. The following may be quoted² from the works of Dampier (17th century): "The Darien Indians preserve them (bananas) a long time, drying them over the fire, mashing them first and moulding them into lumps." "A ripe plantain, sliced and dried in the sun, may be

¹ Fawcett, W. 'The Banana,' 1913.

² *Ibid*, p. 109.

preserved a great while, and then eats like figs, very sweet and pleasant." Pere Labat¹ (17th century) also writes: "To preserve them (bananas) like figs, raisins and other dried fruits, they are allowed to ripen thoroughly in the house, in which condition the skin is very easily removed; they are then cut lengthwise into four, and dried on a trellis-like stand in the sun or in an oven after the bread has been baked; the fruit becomes covered with a white sugary powder deposited from its own juices. In this condition they will keep for years."

Fawcett states that banana "figs" (dried slices) are being manufactured and exported from Jamaica. In India, Travancore is the only other place besides Agashe that he mentions as a home of banana-drying.

In Fawcett's book and in various other treatises on foodstuffs, analyses of the unripe and ripe banana are given which show that it is a valuable nutritive substance. Drying of it means the production of a store of easily preserved food against famine or to vary a diet. Moreover, in many places a certain number of banana fruits go to waste for want of an immediate market. The drying of the fruits would obviate this waste.

PRELIMINARY EXPERIMENTS AND DIFFICULTIES.

The earlier experiments were carried out in Bassein, a town on the west coast of the Bombay Presidency with a climate similar to that of Agashe. Bassein is practically at sea level, its average rainfall is 83 inches, and its temperature in the shade during the whole year is very equable owing to the nearness of the sea, the mean maximum temperatures for January and June being 87° and 91°F., and the mean minimum temperatures 60° and 78°F. Drying was first of all done in a small wooden box open to the sun on the upper side. The varieties *Kajeli* and *Tundo* were used. This was in December 1916. The bananas thus dried developed maggots in March of the following year.

The next lot were dried in April and May 1917. In this case the following varieties were used: *Basrai*, *Bankeli*, *Budubali*, *Satsalandu*,

¹ *Ibid*, p. 113.

Mutheli, Red, and a yellow sport of Red. The open side of the box was covered by muslin or wire gauze. The bananas were taken out of the boxes at night, and kept indoors to prevent them being damaged by dew. One or two boxes were covered with glass panes and these with the bananas drying in them remained out night and day, but were covered at night with gunny bags. After drying the bananas were packed in small bundles, wrapped in banana leaf-sheaths, and put in biscuit boxes. These were sent to Poona where they were kept in a room in the Agricultural College on a shelf without any special protection.

In the manufacture of this batch two points arose. In windy weather bananas under gauze or muslin were apt to get covered with dust. Also ants sometimes crept up into the boxes and attacked the bananas. It was therefore obvious that boxes with glass covers were best and that they should rest on stands with their legs in bowls of water to prevent the ascent of ants. This batch was re-examined in September 1917, when some packets were found to be sound and others maggoty.

FINAL FORM OF THE DRYING APPARATUS.

An apparatus was now devised which obviated all causes of failure. It is shaped like a flat museum show-case supported on four legs (Figures, 1, 2 & 3). Each leg is two feet in height.

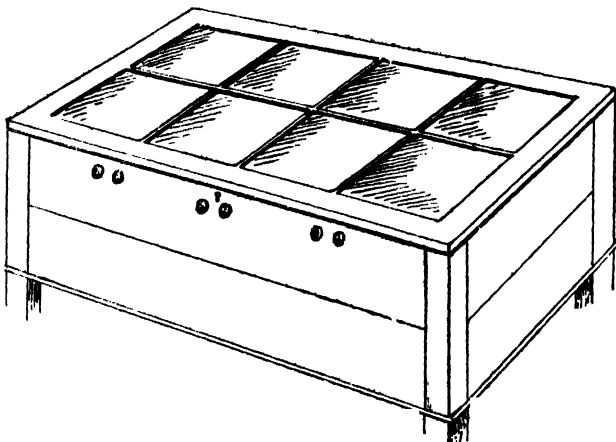

FIG. 1. Banana-drying case.

The box used was one foot broad by four feet long by two feet deep, but may of course be of any size convenient. The lid is of glass,

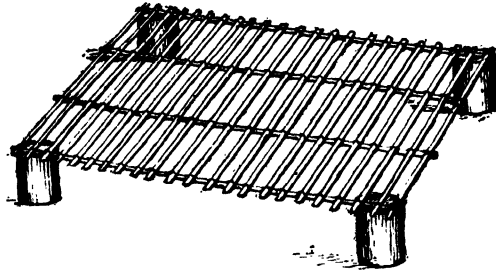

FIG. 2. Framework for bananas.

hinged on to the body of the box. All joints should be insect and dust proof. In the floor and in the two long sides of the box are eighteen ventilators, round holes about half an inch in diameter, six to each side and six to the floor. These are closed by wire

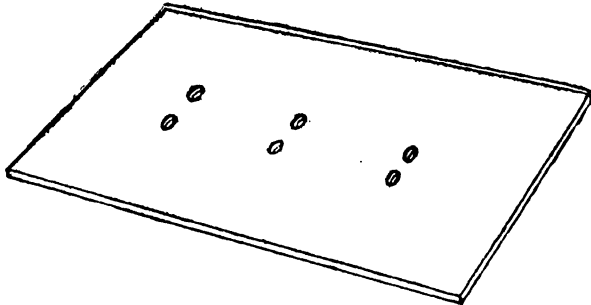

FIG. 3. Bottom plank of the drying case.

gauze inside, and there are also bungs for stopping them up entirely at night. A false floor of cane lattice-work rests on four blocks four inches tall on the bottom of the box. This is the actual tray on which the bananas rest.

Experiments with this apparatus were carried out in Kirkee, elevation above sea level 1,850 ft., rainfall 27 inches per annum, maximum average temperatures January and June 85°F. and 86°F., minimum average temperatures 53°F. and 72°F.

In November 1917, several varieties of bananas were dried in the above apparatus and exhibited at the Food Products Exhibition

at Calcutta in January 1918. The dried bananas on being taken out of the apparatus were packed in wide-mouthed glass bottles, the mouths of which were luted with paraffin wax. Some of these bottles got broken in transit. The contained bananas were taken out and repacked in other bottles. These bananas showed mould after a few weeks. The others remained sound.

FURTHER EXPERIMENTS.

In April 1918, the following varieties were dried: *Karanjeli*, *Kalhi*, *Bankeli*, *Walhe*, *Soni*, and *Rajeli*. Half of them were wrapped in oil-paper and packed in tins, the other half were put loosely into glass jars. They were examined in June and September 1918, and finally on May 5, 1919. At the first examination it was found that two bananas of the *Kalhi* variety showed a growth of mould. These two were removed and the whole lot that had been in contact were exposed again to the sun for one day and repacked. There was no further attack. The rest of the bananas were sound all the time, and some were still sound in October 1919, having kept eighteen months.

It seemed that it was advisable to examine the bananas periodically in order to check any possible growth of mould. An examining box consisting of two panes of glass in a frame, so that the examiner can put his eye close to the fruit without breathing on it, was devised and is useful.

DEVELOPING A DESIRABLE COLOUR.

Under strong exposure to the sun bananas tend to take on deep colours and in weaker exposure the colours are pale. Bananas that have dried brick-red often turn black on keeping. A bruised or over-ripe part dries black. The product takes the final colour about two days before the final drying. The ideal is pale saffron as a finishing colour, so that, after keeping, an attractive shade of red will be visible. This is obtained by using bananas that are exactly ripe but not over-ripe, and by putting a cardboard over the dried or rather drying bananas in the box for the last two days of the

process. This method applied in February 1919 gave an excellent saffron-coloured product that had turned a red in October 1919, and remained perfectly sound.

THE PROCESS.

The following is a résumé of the process:—

- (1) Get fully ripe but not over-ripe fruits.
- (2) Peel them and scrape the outside of the fruit with a bamboo scraper to get rid of all shreds of skin.
- (3) Put the peeled bananas on the cane lattice tray and shut the lid; put the frame out in the full sun, with its legs in water bowls.
- (4) When the temperature begins to fall below 95°F. in the sun close the ventilators with bungs.
- (5) At night cover the whole frame with a thick gunny bag, or (if rain is expected) with a tarpaulin.
- (6) Turn the fruits daily. It will take from four to six days for the fruits to dry. Finish under cardboard as described.
- (7) Pack in tins or jars with tightly closed mouths.
- (8) After two months look over the batch, pick out mouldy or maggoty bananas and expose those of the same tin or jar for a day to the sun in a frame.

Twenty to thirty moderate-sized bananas make one pound of dried material.

NATURE AND USES OF THE PRODUCT.

The material finally made by us is a most delicious sweet-meat eaten raw. It can be made into excellent jam. While one of us was on leave in England, he received from the other two biscuit tins of dried bananas. The first was packed on 26th March, 1919, and opened on 12th May, 1919. The fruits were in perfect condition and remained so although exposed to the air till 11th June, when they were cooked. The other was packed on 1st May, 1919, and

opened on 11th June, 1919, and made into jam. This was most heartily appreciated by all who tasted it.

The dried material can be used for making up into various dishes, such as puddings or various Indian preparations.

CONCLUSIONS.

Bananas can be dried at other places than Agashe, and all varieties that we have experimented with can be successfully dried.

Sun heat is sufficient.

Protection from dust and insects is necessary, and some sort of simple apparatus such as that described by us is required.

A good colour can be obtained by using a cardboard screen for the last two days of the drying.

The product should be stored in airtight tins or jars and examined periodically, throwing away bad bananas and drying again those likely to have been infected.

We have indicated only the simplest possible method of drying, one suitable to the most primitive conditions. Doubtless if there were an assured market, vacuum driers and modern scientific apparatus would be desirable. In the meantime all we wish to show is that by a very simple apparatus a valuable and easily stored food can be made from a perishable fruit.

After writing the above, the writers' attention was drawn to an article¹ describing experiments on the drying of bananas in Jamaica. The main conclusions of these experiments of interest to India are:—

- (1) The sun-dried product is superior to the product artificially dried in a drying apparatus.
- (2) With a good supply of sound fruit at 1*d.* per lb. and a selling price of 6*d.* a lb. a profitable industry could be established in the West Indian islands.
- (3) Fruit merchants in the United Kingdom valued the sun-dried bananas at 6*d.* per lb. there wholesale in July, 1919.

¹ *Agricultural News*, September 6, 1919, p. 276. Article on "A Dried Banana Industry," unsigned.

PS.—On 28th August, 1919, a sample of bananas dried in the above manner was sent by us to the Chamber of Horticulture, London, for opinion.

That body sent on the sample to a firm of specialists in the banana trade who reported as follows :—

Elders and Fyffes, Limited.
Head Office,
Bow Street,
London, W. C. 2.

Report on Dried Bananas received from the Secretary, Chamber of Horticulture.

“ The tin box contained four small parcels, two marked ‘ Black Colour ’ and two marked ‘ Red Colour . ’ All four parcels are in perfectly good condition and sweet. An outstanding feature is the complete dryness of the fruit, in which it compares favourably with the Jamaican variety. All the fruit is of good flavour.

“ The samples marked ‘ Red ’ are much brighter and more attractive in appearance than those marked ‘ Black , ’ and the sample marked ‘ Red 1 ’ is the best in every respect.

“ During the past thirty years many attempts have been made to introduce dried bananas into this country, notably from the Canary Islands, but meeting with poor results the efforts have been short-lived.”

“ During the war small consignments were imported here from Jamaica and sold readily owing to the scarcity of other dried fruits, but at the present time, notwithstanding the continued shortage, the demand at remunerative prices is negligible.

“ It is difficult to speak hopefully of the prospects for the future as it is thought that in normal times the competition of other products of a similar character will be to the disadvantage of the industry.

“ 14th November, 1919.”

PACKING SEED SUGARCANES FOR TRANSPORT.

BY

T. S. VENKATRAMAN, B.A.,

Acting Government Sugarcane Expert, Coimbatore.

INTRODUCTION.

EXPERIMENTS to ascertain the best method of packing sugarcanes for transport, as seed, have been engaging the attention of the Cane Breeding Station, Coimbatore, from its very inception in the year 1912, as it was early realized that such transports were bound to play a very important part in the future work of the station. Further, the requirements were soon found to be of a varied character, both as regards time occupied and mode of transport, whether as parcel by rail or steamer, or as packet post. The need frequently arises for sending out details of packing to would-be consignors, and this note, based on the experience of the station for the past seven years, is written to give a wider publicity to the methods employed, as they have proved successful. The methods described herein were evolved under the guidance of Dr. C. A. Barber, C. I. E., and Mr. R. Thomas, Sub-Assistant at the Sugarcane Breeding Station, greatly helped in the details of the work. Two plates (Plates XI and XII) are appended to illustrate the methods described in this note.

Because of the possibility of obtaining planting material even from immature canes, and the rapidity with which a single sugarcane bud gives rise to shoots ultimately developing each into one cane, it is unnecessary, except when absolutely required, to transport a large number of canes as planting material from one place to another.

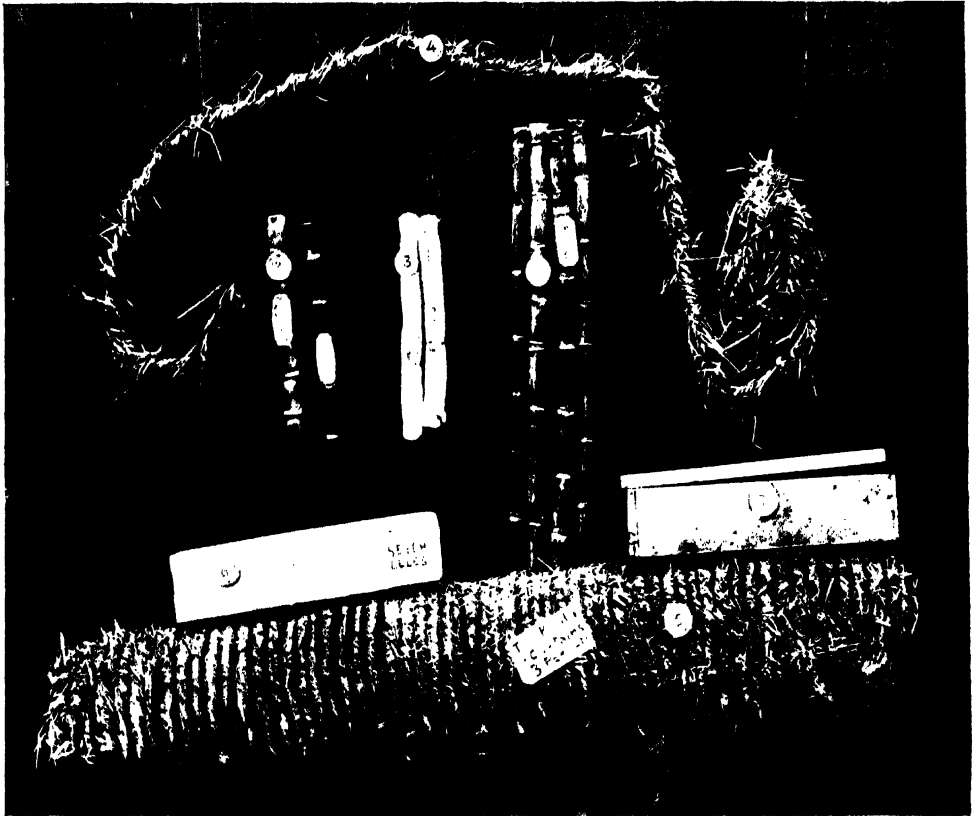

PACKING OF SEED SUGARCANES FOR TRANSPORT.

- 1.—Canes cut to four-foot lengths and ends dipped in paraffin for short distance transport.
- 2.—Cane pieces cut to lengths of one foot three inches, and treated as detailed in the text for oversea consignments.
- 3.—The same after being wrapped round in cloth.
- 4.—Paddy twist as used in such consignments.
- 5.—Bundle of canes tied round *tightly* with paddy twist and ready for being enclosed in gunny. (For short distance transport.)
- 6.—The oversea postal packet ready for forwarding.
- 7.—A tin case used for oversea packets.

Note the labelling of individual pieces for oversea consignments and the manner in which the labels are attached to the canes.

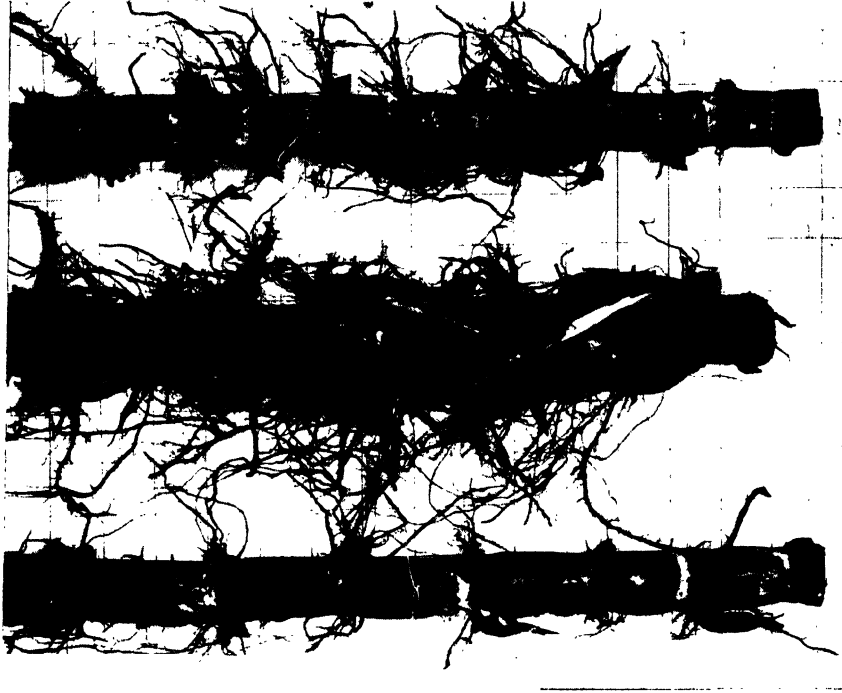

A postal packet from Antigua. The journey occupied 58 days.



Cane cuttings packed for overseas, but kept at the station for testing, and opened after 64 days from date of packing. This lot contained 14 buds and planting gave rise to 13 healthy plants.

Theoretically, it may be assumed that, in one year, a single bud is capable of giving rise to about 100 buds in the case of the thick canes and 300 buds in the case of the indigenous varieties. It, therefore, follows that, in a couple of years, one can hope to raise 100 plants from one bud of a thick cane and 300 plants from that of a thin cane. The aim kept in view was, therefore, more to transport a few buds in a healthy condition than to send out a large number whose vitality at the end of the journey was likely to be of a doubtful nature.

CERTAIN MAIN CONSIDERATIONS.

It was soon realized that the three most important considerations in the transport of cane material for packing were:—

- (1) Protection of the cut ends, to prevent evaporation and the consequent drying up of the material during transport.
- (2) Protection of the buds, to prevent their rubbing against one another or against other cane surface during the journey, resulting in their being rendered incapable of germination at the end of it.
- (3) Treatment of the material, to prevent entry of disease through the cut ends and, if possible, to destroy any disease that may already exist in it.

THE MATERIAL.

The selection of proper material is an item of great importance in the transport of cane for seed. The clump selected for obtaining material from should be healthy and vigorous. Occasionally, a clump which, on the whole, is poorly and stunted, may show up a healthy cane or two; but it is better to avoid such a suspicious material. Tops of canes do not journey satisfactorily, while pieces obtained from "butts," especially when the canes are fully mature or overmature, not infrequently contain buds which are hollow and therefore incapable of germination. The appearance of such buds is often very deceptive and their real condition is often ascertainable only by exerting a certain amount of pressure on

them with the fore-finger. Generally, the middle portion of a cane, not overmature, yields the best material for transport. The ideal pieces for packing should possess buds, firm to the touch, not at all swollen or bursting and with no visible external injury, either in the buds or in the adjacent internodes.

Before removal to the place of packing, the selected canes should have the leaves and tops removed in the field itself, as, otherwise, these by transpiration take off too much moisture from the canes.

TREATMENT AND PACKING FOR SHORT-DISTANCE TRANSPORT BY RAIL OR STEAMER.

At the packing shed the canes are cut to four feet lengths—or to any length considered suitable for the parcel—and the freshly cut ends dipped in paraffin wax kept ready melted for the purpose.* This is done to prevent the drying up of the canes during the journey by evaporation from the cut ends and to prevent the entry of disease through these ends. The pieces belonging to the same variety are now bundled together, *not too tightly*, with some soft material between individual pieces. Loose paddy, *ragi* (*Eleusine coracana*) or wheat straw or some fibrous material such as *sann*, *gogu* (*Hibiscus cannabinus*) or coconut fibre have been found useful for the purpose. In very dry weather this packing material receives a sprinkling of water to prevent too much desiccation of the canes during transit. While bundling up, care should be taken to see that the coir, or other material used in binding, does not come into direct contact with the cane pieces, especially the buds, as the slight movements which are inevitable in the further processes of packing and actual transport are sufficient to destroy the buds. These individual varietal bundles are then labelled both inside and outside and all united together into one parcel by being tied round *tightly* with paddy twist. This is then stitched round *tightly* with gunny, addressed, and is ready for despatch.

* For this and similar other purposes mentioned in this note, white paraffin wax melting at 135-40°F. has been found suitable. The paraffin is placed in an iron or porcelain basin, sunk to below its mouth in a bucket of water and the water brought almost to the boil. This melts the paraffin in the basin and keeps it in this condition for some time.

For railway transport it is advisable not to make the bundles too small, as they are then liable to be thrown in and out of railway carriages. These packages should be of such a size as to require rolling over. Most railways now insist on the addresses being written directly on the gunny and the packages are safer thus.

Such transports are generally between places where there is no risk of introducing a new pest from one locality to another, and, therefore, the material is not specially treated with insecticides or fungicides. Care is, however, taken to see that the material is free from disease by a very careful examination both in the field and in the packing shed. If the material to be transported consists of but a piece or two, these are best sent by parcel post, which, on occasions, is cheaper as well. Such post parcels need a greater amount of packing between the individual pieces because of the greater liability to desiccation and handling in this form of transport. In the experience at the station this method of packing has been found to be adequate for journeys extending to periods up to at least a month.

TREATMENT AND PACKING FOR OVERSEA CONSIGNMENTS.*

In oversea consignments the conditions during transport are more strenuous and a more elaborate method of packing than that described above is required.

Large-sized boxes are unsuitable because of (1) heavier transport charges, (2) slowness of the journey, and (3) greater liability to damage in transit unless very expensively packed. Small-sized tin cases, 18" × 4" × 4", with the lids made like that of a pill-box, and forwarded by post, have been found the most suitable. If these are carefully japanned both inside and outside to prevent rusting, and strengthened with bits of iron rod placed along lines of greatest strain, these may be used over again at least twice.

* A description of the method as adopted in the West Indies is to be found in the *Agricultural Journal of India*, IX, 4, p. 392.

In such consignments which are generally over long distances often separated by seas, the transported material requires treatment to prevent the unwary introduction of diseases from one locality to another. Besides the very rigorous examination in the field and in the packing shed, the cane pieces are pickled from half to three-quarters of an hour in a 4 per cent. solution of copper sulphate or Bordeaux mixture of similar strength. After removal from the solution, the ends are wiped clean, allowed slightly to dry, and then dipped in melted paraffin wax.

For oversea consignments the packing material requires to be softer and finer, and well-sifted charcoal dust—copied from West Indies practice—has been found satisfactory. An additional protection is given to the canes by wrapping them individually in bits of thin cloth. Such journeys often extend to two months—during the war it occasionally used to take even three months—and so a certain amount of moisture is provided in the packing material to prevent drying of the canes during the voyage. The most satisfactory proportion has been found to be, as much weight of dry charcoal as weight of canes to be packed, and half its weight of water to be added to the dry charcoal powder. A series of elaborate experiments, involving the packing of sixty tins, with different materials for pickling, packing and wrapping the canes and with varying quantities of water added to the packing material, has shown—

- (a) that charcoal powder may be substituted by “teak saw-dust” without any disadvantage;
- (b) that wood shavings—the packing material received with Europe stores—may be substituted for charcoal with advantage; with this packing, the parcels are lighter and the buds travel better; and,
- (c) that formalin of varying strengths as pickling solution and tissue paper as wrapping material are unsatisfactory.

The tin cases are now wrapped in brown paper or newspaper—just a layer or two—stitched *tightly* round in white cotton cloth and addressed. A duplicate addressed label, treated with paraffin, is enclosed inside the cloth packing and is sufficiently visible through

the cloth to enable the package to be directed, should the addressing on the outside become indistinct during the journey.

LABELLING CANE MATERIAL INTENDED FOR TRANSPORT.

This most important item is occasionally not done with sufficient care. One cannot lay too much stress on its importance, as bad labelling may involve the complete destruction of the whole material, at the end of the journey, as unreliable for accurate work, or, what is worse, introduce serious errors in naming.

For short-distance transport it has been found a good plan to write the labels clearly in pencil or ink, dip them in melted paraffin, and fasten to the pieces with strings similarly paraffined. This treatment makes them proof against injury through moisture or dirt during the voyage. Should they get soiled however, all that is required is to wash them in water, to make them appear as bright as before. Such labels should be fastened adressed to the canes and not allowed to hang from them, as in the latter case they are liable to be torn or otherwise mutilated in the subsequent handling of them. Every individual varietal bundle should possess two such labels—one inside and fastened to one of the cane pieces, and the other outside attached to the bundle.

For oversea consignments the usual practice is to use a tin or zinc label punched with the name or number of the cane and attach it directly to the cane with a piece of wiring. This is satisfactory, but experiments conducted at the station have shown that the paraffined labels described above serve equally well and possess the following advantages besides :—

- (1) They are cheaper and neater. The metallic ones are often not easily decipherable at the end of the journey on account of rust except after careful washing.
- (2) Because of their greater pliability, they are easier attached to the canes and less liable to injure the cane surfaces or the buds.
- (3) These are not liable to rust as the metallic labels or the wiring, a common source of trouble in such consignments. Such labels, whether of metal or paraffined

paper, are best placed inside the cloth wrapper and next to the canes. In the case of oversea consignments it is important that every piece should be individually labelled.

For some time past the idea has been steadily gaining ground that in the transport of cane material for planting the internodal portions are unnecessary, and experiments are under weigh to further simplify the oversea packing by including only the nodes.

SWARMING CATERPILLARS OF NORTHERN GUJARAT.

BY

T. N. JHAVERI, L.Ag.,

Assistant Entomologist, Northern Division, Bombay.

IN the early part of the monsoon of 1919, after the long and almost unprecedented drought which had resulted in the famine of 1918-19, the people were alarmed to find that their crops were attacked by swarms of small dark brown caterpillars, which appeared likely to do a very great deal of damage. These pests attacked the early sown crops of maize, *bajri* (*Pennisetum typhoideum*), *kodra* (*Paspalum scrobiculatum*), and chillies, while rice seedlings and grass on the higher lands were also much damaged. They seem to be confined to the parts of Gujarat where a light (*goradu*) soil occurs, but in these regions they were found in Surat, in Kaira, in the Panch Mahals, and in Baroda.

The pests, though not unknown previously, had never occurred in anything like the abundance in which they were found in the present year. The first sign was usually a certain amount of destruction of the leaves of the crop. Sometimes on an examination of the leaves at this stage a group of small brown caterpillars was found: sometimes the caterpillars were larger, coloured a velvety black or grey brown with stripes of dark and yellowish grey on the back and sides, with black spots. In the case of the cereal crops above named, at this stage they were often found in the funnel composed of the leaf-sheaths round the central shoot of the plant. When examined the pests revealed themselves as two well-known swarming caterpillars, *Prodenia litura* and *Cirphis loreyi*, recognized as most serious pests of crops in many parts of the tropical world.

The source of the exceptional attack in 1919 was probably the absence of rain for a very long period. The caterpillars pupate in the ground, chiefly in the higher land, at a depth of two to three inches. The pupa is unprotected by a cocoon, and simply is enclosed in a small chamber of earth. Under conditions of normal moisture, it remains in this condition from one to six weeks, but with the exceptional drought it is quite possible that the pupæ may have remained much longer than this time. At any rate the first rains of the second week in June were followed by a very large emergence of moths which laid eggs on many plants, but particularly on the early sown crops and on the grasses which were just springing up. As each female moth was found to lay about five hundred eggs, in several masses, along a leaf, and as these eggs hatch in about four days, it will be easily seen that by the end of June the small caterpillars were spreading over all the suitable crops growing at that time. As the caterpillars grew older, they were found feeding especially in the early morning, evening, and at night. During the hot part of the day they were chiefly hiding in the soil or concealed at the base of the leaves of the plant attacked.

Most of the caterpillars which appeared at the end of June disappeared in the third week of July. Those which had become full grown retired to pupate in the soil; others were very much parasitized by tachinid fly parasites. These latter parasites were found as small maggots on the viscera of the caterpillars, while their eggs were noticed also on the surface of the worms. At this time, too, there was a good deal of heavy rain, and on examining the soil of the higher lands, a good many (in fact, by far the majority) of the pupæ discovered were found to be in a decomposing state, probably as a result of the wet conditions in which they found themselves.

Partly, therefore, as a result of the parasites which had appeared, and partly on account of the seasonable rain, the much dreaded second brood, which should have appeared early in August, never came out in any serious numbers, and the alarm which had prevailed widely in the early part of July gradually disappeared. The

observations which were made in connection with this attack, however, lead to a number of methods which will, if widely practised, probably prevent the attack of these caterpillars being serious another year.

The first of these preventive measures is to have the land ploughed up before the rains come, or still better as soon as the previous crop is harvested. By this means the pupæ which will certainly be in the ground will be turned up, and either dried out by exposure to the sun, or devoured by insectivorous birds. In this connection it appears especially important to plough up the high lands, and the strips of grass so often found between fields. The ploughing up of these latter once every two or three years will assist a good deal in controlling several insect pests of the crops.

The moths, at least of *Cirphis loreyi*, are, moreover, easily attracted to light, and if the fields are provided either with a number of lamps each standing in a tray of kerosine and water, or with a few fires made of dry brushwood for a few days after the first rain and the consequent emergence of the moths, a very large number will be destroyed before they have had the chance to lay eggs.

Again, a good deal may be done by delaying, for a few days, the sowing of the crops. It is a frequent practice to sow crops as soon after the first rain as possible. This was done very largely in 1919, and the crops so planted were those most attacked. The crops planted a fortnight later, the time between having been used for ploughing, harrowing, and otherwise preparing the fields, were hardly attacked at all. This is in accordance with what is known of the life-history of the insect, and would probably apply equally in another year.

If these precautions be widely taken, little else will be needed, though the employment of children to collect and burn the leaves, on which the very prominent egg masses have been laid, might pay in special cases. The same children might also collect leaves on which the gregarious swarms of the very young caterpillars are feeding. It might also be worth while, in the case of seed beds or fields of valuable crops, to put a trench round the bed or field, in

which green stuff or grass can be put in the evening. The large caterpillars sheltering in it can be destroyed on the following morning.

While the pests here discussed do not seem in any sense to be pests of the first importance, the widespread alarm and damage which they caused in Gujarat in the present year would seem to justify attention being called to them and indications being given of how a similar attack can be prevented or dealt with in future years.

Selected Articles

THE GROWTH OF SUGARCANE.*

BY

C. A. BARBER, C.I.E., Sc.D., F.L.S.

I.

IT is proposed, in the present and succeeding articles, to discuss certain points connected with the growth of the sugarcane. The average planter has little time to conduct researches on plant growth in the field, and, naturally, leaves these to the officers attached to the experiment stations. But these researches are often expounded in highly technical language, assuming a thorough knowledge of plant morphology and physiology. It is also too often forgotten that they have been conducted under one great disadvantage, for the conditions in the small experimental plots, with their intensive cultivation, are very different, in most cases, from those in the large cane fields. All laboratory results have, therefore, to be checked, that is worked over again, in the field conditions, and it is of great importance that they should be expressed in as simple and attractive terms as possible. But, independently of this, there are many directions in which the planter can quite easily make observations and carry out experiments of his own for the improvement of the crop, instead of blindly following local custom in all its details. The chemist has shown that the manurial requirements of the cane vary with the soil, its treatment, the climate, and the variety planted ; and it is probable that there are other sides of field practice

* Reprinted from *The International Sugar Journal*, October 1919.

which should also be modified according to variation in these conditions. Even on adjoining estates small differences occur, and it is only the man on the spot who is aware of these. But to reap the full advantage of such work requires a fairly thorough knowledge of what goes on in the cane field, and how the cane set, planted in the ground, increasing a hundredfold, gives rise to the great mass of canes which are cut at harvest time. It is for the agriculturist, then, that these articles are written. They will not be loaded with technicalities, and their ultimate object will be to indicate in what direction observations and experiments can be made in the field, so as to produce healthier plants and a greater crop of ripe canes at crop time.

The parts of the sugarcane above ground, the stalks, leaves, shoots, and flowers, have received a great amount of attention, and many interesting facts have been noted in the fields. But, once the cane set is planted, little is to be found in current literature as to what changes take place before the cane shoots appear above ground. It will be fairly obvious that the number of shoots emerging and the vigour of their growth will depend, in the first instance, on the development going on in the soil. Here the foundation is laid for the future plant, and the production of a good crop of canes is dependent on the proper treatment of this foundation. The length and thickness of the individual canes, the even ripening of the crop, the tillering power of the variety planted and the total yield of canes and sugar at harvest, are all decided in this subterranean laboratory.

As is well known, the sugarcane is always planted in the field from sets, pieces of the mature cane with three or four buds, or the "tops," immature joints with a greater number of less developed buds. Each of these buds is itself capable of producing a full-grown plant, and the reason for planting several of them together is to ensure an absence of blanks, which are such a serious drawback to any field crop. For a study of the development of these buds, it will be convenient, for our purpose, to consider the growth of the cane plant from the actual seed. The stages are the same in both cases, but the growth from the seed is much slower, and we can better

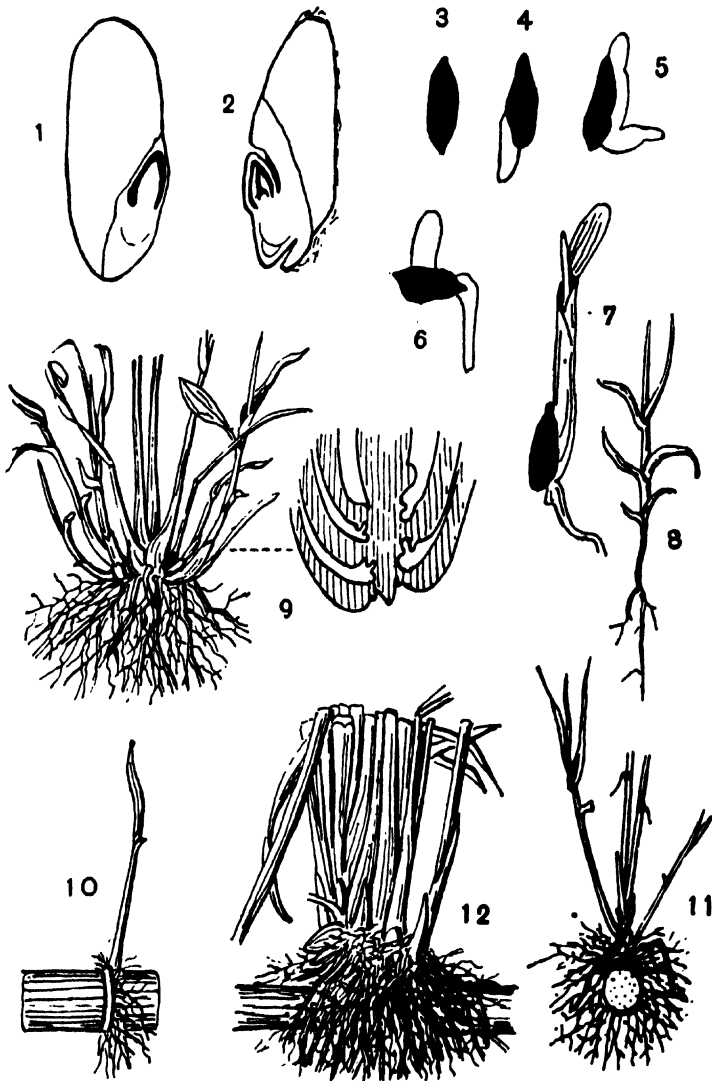

Fig. 1. Vertical section through a sugarcane seed; Fig. 2, through one commencing to germinate. Figs. 3—7. Germinating cane seedlings, three-four days old. Fig. 8, an older stage showing the two rows of leaves on the stem.

Fig. 9. A four months old seedling with its bunch of leaves and mass of roots; at the side the same bunch has been dissected out to show that the leaves are really, as in Fig. 8, all in one plane.

Fig. 10. A germinating set, showing the root development from its root-eyes.

Fig. 11. A later stage with two thick roots from the joints of the young plant.

Fig. 12. A cane plant 50 days old, still attached to its set.

learn the way in which the strength and vigour of the plant are built up and the way in which the branches are formed, by following the stages of growth in a seedling cane. The seed of the sugarcane is excessively small, and many of the "arrows" or "plumes," so delicate and beautiful in the fields, contain numbers of seeds hidden away among minute, chaffy scales. The arrow of the cane is thus, in essentials, similar to an ear of corn, although few people would imagine that these were anything but a mass of feathery grass flowers. The average cane seed is 1.5 mm. long and 0.5 mm. broad. It is somewhat of an anomaly that, while these are among the smallest of grass seeds, the full grown plant is such a giant among them, for the cane plant is nothing but a huge grass. A series of germinating cane seeds (greatly enlarged) have been drawn on the accompanying plate (Plate XIII, figs. 1-7). Anyone acquainted with the germination of wheat or barley grains will at once recognize that the parts are practically identical. But the amount of nutriment in such a small seed must, of necessity, be extremely limited, and therefore the vitality of cane seeds is not great. They quickly dry up and perish—a fact which is no doubt responsible for the comparatively recent discovery that the sugarcane produces fertile seed at all.

The mature cane consists of a series of joints, each of which has three essential features in its lower part, a leaf, a bud immediately above it and a narrow ring of tissue covered by small dots or root-eyes. The leaves and buds are placed on the cane stem alternately, right and left, in one plane, accounting for the fact that the terminal tuft is so often shaped like a fan. This arrangement is seen in the young cane seedling from the start (Plate XIII, fig. 8). The joints are extremely short at first and as there is not room for the leaves to develop and expand in the same plane, they appear at the surface of the ground in a bunch, evenly distributed round the stem. But a careful dissection shows (Plate XIII, fig. 9) their true arrangement, and that they are in two vertical rows on opposite sides of the stem, just as in the mature cane. The leaves grow much more rapidly than the stem, so that the first part of the plant appearing above ground is a number of leaf tips, the stems not emerging until their leaves are three or four feet long. The first joints of the future cane may, soon

after this stage, be detected between the leaves at the base of the plant.

But this description only accounts for a single cane shoot. At a very early stage, the minute buds above the individual leaves, that is to say, in their "axils," also start growing out, and form shoots in all respects similar to the parent stem. They, likewise, have their parts arranged in one plane, and here again a struggle for space causes the leaves to push one another aside, and bunches of leaves appear above ground. We thus get a further complication in the arrangement of the parts of the growing plant; but we know from our dissections that all the leaves and stems of our branching cane plant could, theoretically, be pressed flat in one plane, as on a piece of paper. The way in which this redistribution of space is brought about need not detain us here, but there is, obviously, a good deal of torsion and twisting going on underground, before each organ is able to find its place in the air and light; and, in the process, many fail to do so and are squeezed out of existence.

There are, as in all grasses, two periods of growth in the sugarcane. The first of these (as far as the stems are concerned) is underground, where branching takes place, the second when these branches are pushed into the air and rapidly assume the form of separate canes. But the success with which the latter action is carried out depends entirely on that of the previous underground preparation. This, then, is, for our purpose, the more important period of growth, for the work done then regulates the tillering capacity of the whole plant and the number of canes produced. Each branch of the main stem, termed a branch of the first order, soon gives rise to branches of the second order, still in the same plane, and the whole complex becomes more and more intricate and difficult to dissect out, so as to show the true relations and positions of the various members. We ultimately see a considerable bunch of canes, and the number depends largely on the space available, that is, the nearness of the organs to one another and of each plant to its neighbours.

Now all this branching takes place underground in the first period of growth and it abruptly ceases as a stem emerges from the

soil. We only know, from an observation in the field, that the plant has germinated and is growing by the protrusion of its leaves. If we lift up a plant and wash away the clinging earth we see nothing but a mass of roots. All of these have arisen from the outgrowth of the root-eyes, and each leaf has a considerable number devoted to its use. The early protrusion of the leaves is a fundamental necessity of the plant, because, while the roots obtain salt and water from the soil, the leaves have, if anything, a more important part to play in the feeding of the young plant. It is mainly through them that the carbonic acid gas of the air is decomposed in the presence of sunlight, and the carbon of the plant obtained. It is, perhaps, needless to point out that, in sugar, the final product of the plant's activity, carbon, holds a predominant position. The amount of stored food material in the seed (or set, if grown from cuttings) is small, and it is of the first importance that the leaves formed by its help should emerge as early as possible so as to be in a position to produce more food, for only thus is the material rendered available for the rapid formation of the roots at the bases of the leaves. In the general growth of the plant the water and salts provided by the roots are combined with the carbon of the air to form the tissues of the rapidly succeeding organs.

Let us now pass on to the planted set. There is a good deal of water and other nutriment in the joints of the piece of buried cane. But this cannot be fully utilized by the buds until an abundant flow is available, both to assist in the chemical changes and to wash the dissolved food into the expanding shoot. For this reason the first stage of development here is the protrusion of the root-eyes found in the rings of tissue adjoining the buds. And these root-eyes of the set at once respond to the heavy irrigation usual in planting the sets. A mass of roots is thus formed which, it may be noted, being given off by the set above, form no part of the new plants produced from the germinating buds (Plate XIII, figs. 10-11). As soon as joints and leaves are developed in the bud, new rows of larger and more permanent roots grow out, and the old wiry roots of the planted set become effete (Plate XIII, figs. 11-12) and with the joints bearing them die and gradually decompose. Each plant arising from

a single bud soon becomes independent and separates itself from the parent set. The development of the shooting bud is, in fact, exactly similar now to the germ in the seed, but it is much more rapid. The plant produced from a set in two months from planting is about equal in height to a six months' seedling and is growing much more rapidly. The young stem of a germinating seed has but the thickness of a fine needle, and many joints must be formed, each thicker than its predecessor, before it becomes of appreciable size. A considerable amount of energy is used up in this increase in diameter, and a vertical section through a seedling stem has the form of an inverted cone with a sharp apex (Plate XIII, fig. 9). The bud on a set has enfolded, within its outer waterproof scales, a whole set of minute leaves with joints between them, all completely modelled and merely waiting for the flow of dissolved food to swell out; and the thickness of the stem at the base is somewhere near that of a lead pencil. There is still some measure of thickness to be attained, but, with the more advanced stage of the leaves and the send-off of the roots of the set, this takes very much less time. The cone of section of the stem has a very blunt apex.

Each bud of the set produces an independent plant. The bunch of canes in the field, which appear to form a single bush, in reality consists of several plants closely intertwined, the individual members of which are engaged in a strenuous struggle for space for their roots in the soil and for their leaves and branches in the air. As many members are unsuccessful in their struggle, the base of a cane plant is full of dead stems, leaves and buds, and the question naturally arises as to whether this mode of planting is an economical arrangement. Much of the strength of the plant is undoubtedly wasted in the production of organs which cannot fulfil their destiny, and an enormous number of canes of all ages habitually die before they are fully developed. One writer advocates the planting of single-bud sets, but we shall return to this subject on a future occasion, merely suggesting that the point is one in which experiments in the field are to be desired.

WHAT THE TUCUMÁN EXPERIMENT STATION HAS DONE FOR THE ARGENTINE SUGAR INDUSTRY.*

BY

ARTHUR H. ROSENFELD,

Field Manager, "Ingenio Santa Ana," Tucumán, Argentina.

THE Tucumán Experiment Station was established by law in 1907 by a more than usually progressive Government, in order to study the causes of the constantly falling-off yields of cane in Tucumán cane fields. At the time of the law being passed it had been evident for several years that the cane was suffering either from some distinct disease or from a general degeneration—a phenomenon which had already occurred in several countries where this type of cane (Cheribon) was before mainly cultivated. The work of the new station, due to the necessity of finding competent *personnel* for work under the peculiar conditions of Tucumán—conditions most closely approximated by those of Louisiana—and of obtaining proper apparatus and securing sufficient data with which to begin serious investigational work, was started only in 1910. Experiments were begun along numerous lines of investigation, looking towards the improvement of the actual methods of cultivation as well as towards lowering its cost by the introduction of modern machinery with which to substitute the use of the expensive, though efficient, plough and spade work so much in vogue in this country. Irrigation and drainage investigations were also begun, and have given many valuable data. In a paper of this sort, however, it is impossible to discuss at any length the detailed experiments which have led to the improvement of the cultural methods of the province of

* Reprinted from *The International Sugar Journal*, October 1919.

Tucumán, so I shall, perforce, limit myself to the most striking and effective results which have by themselves revolutionized the industry of the province.

It was early seen that the native canes of the province were indeed suffering from a degeneration similar to that which had wiped out the same class of cane in several countries, notably Java, to give but one example. This degeneration manifested itself more and more clearly in the years 1910, 1911, and 1912, the exceptionally favourable climatic conditions of 1913 and 1914 dissipating to some extent the fears of Tucumán planters by once more presenting fair agricultural yields and splendid industrial recoveries. These yields, however, while comparatively good as far as comparison with recent years was concerned, demonstrated all the more clearly to us at the Experiment Station that the cane was really undergoing a process of physiological degeneration, else the yields under the exceptionally favourable conditions of those years should have been doubled in the field. These opinions and forebodings were justified when the unprecedentedly favourable seasons of 1913 and 1914 were succeeded by the record-breaking *unfavourable* years of 1915, 1916, 1917, and 1918, when Tucumán produced, instead of the 263,000 tons of sugar of 1914, considerably less than half of that amount in 1915, and less than 50,000 tons in 1916 and again in 1917. In 1918, although conditions were far worse than in any other year known, the effect of the new canes, of which we are now going to speak, had begun to be notably felt, the yield for that year being about double that of either of the two preceding ones. Indeed, had it not been for these canes in the crop of 1917 very little sugar would have been made even then, as the area of the native cane had been cut almost in half by 1916, and not more than 10 per cent. of what remained was worth while cultivating for 1917. The small amount of creole cane which is to-day cultivated in the province of Tucumán is attended to more on *sentimental* than on financial grounds.

Now let us see how this remarkable emergency has been met, and if the loss of the staple cane of the province is going to mean the abandonment of the industry, as at one time appeared to be the case.

It was immediately seen that all measures of improved cultivation and more efficient control of water, both for irrigation and drainage, would be well nigh useless unless the basis of the actual cane plantations could be changed by obtaining another variety of cane which, under the most difficult conditions of the Tucumán climate, would give more abundant yields than the native canes.

In 1910, some 126 varieties of cane were imported for trial under Tucumán conditions, directly from the Louisiana Experiment Station at Audabon Park, New Orleans, by the first Director of the Tucumán Station, Mr. R. E. Blouin, who had formerly been Director of the Louisiana Station. These canes represented varieties from almost all the well-known cane countries which were then being experimented with in Louisiana. In the same year, some 76 additional varieties were obtained from the Experiment Station in Campinas, Brazil, and we were fortunate enough to find already in the province six varieties which had been produced from seed in Java at the time that the famous *Sereh* disease had menaced the complete destruction of the Javarese canefields. These varieties had been imported in 1908, as a result of the law creating the Experiment Station, by the then Governor, Luis F. Nougues, one of the most progressive and far-seeing officials that Tucumán has ever had. Since 1910 some 15 or 20 of the more promising new varieties from different countries have been introduced each year and placed under experimentation, many of them giving us far superior results to those of the native canes. It was, however, from four of the six Java seedlings that I have just mentioned that we obtained the canes which have since practically supplanted the native and all other canes in Tucumán, and it is to these four varieties that I shall confine my remaining remarks.

In judging the new canes we had to seek the following points of superiority in comparison with the old ones :—(1) Greater tonnage, with (2) juices containing a higher percentage of crystallizable sugar. (3) Greater resistance to attacks of insects and cryptogamic disease. (4) Ability to stand lower temperature than the native canes. (5) The furnishing of more and better fuel in the shape of bagasse or fibre left after extraction of the juice of the cane. The

crop of 1911 showed up five of the Java canes, J. 36, J. 100, J. 139, J. 213, and J. 234, to be remarkably promising, although the J. 100 was left out of the race from the second year on and need not be considered more here, except that it stands as an example of the danger of jumping at conclusions from the results of one year of experiments under climatic conditions of but that one year. Several prominent cane men of the province were very much enthused with this cane, which is the largest and best appearing of all of them when well developed, and insisted on multiplying it on their plantations for two or three years, only to have to remove it at a considerable expense when it became affected with an even more vigorous degeneration, if the term *vigorous* may be employed in this connexion, than that from which the creole cane was suffering. In this first year the superiority of the Java canes was apparent more in the appearance and luxuriousness of growth than in actual yields, although J. 36 and J. 139 gave about 10 per cent. better yields than the native canes and J. 213 and J. 234, notably the latter, gave better chemical analyses of the juices. The conduct of these canes during crop also seemed to indicate superior resistance to frost attack.

In the crop of 1912, as first year ratoons, the four canes from Java more than doubled the yield per hectare obtained from the native canes under equal conditions, J. 213 giving ninety tons of cane and seven tons of sugar per hectare, against a little over 30 tons of cane and two and one-half tons of sugar for the best native yield. The J. 36 and the J. 139 each gave between 75 and 80 tons of cane per hectare, while the J. 234, producing about sixty tons of cane per hectare, had such a good sugar content in the juice that the sugar produced worked out at considerably more than twice that produced by native canes.

These striking results the second year, while not covering a sufficient range of climatic conditions to warrant us in recommending the canes unreservedly to the planters, did cause us to immediately start large-scale substation experiments near various factories, in order to obtain data under the varying conditions of the province, and, also, to be multiplying these promising canes in case time should

verify their value. It may be mentioned here that all the substation results in the following years confirmed the increasingly satisfactory results at the Central Station, and that we were thus enabled to multiply these canes to a considerable acreage by the time we were able definitely and unreservedly to recommend them.

The crop of 1912 also served definitely to establish the existence of superior frost-resisting qualities in these promising canes, which may be more of a physical than physiological phenomenon after all, due to their thick growth and heavy covering of leaves. We were also able to establish their increased resistance to the moth borer (*Diatraea saccharalis* var. *obliterellus*), due to the hardness of the rind as a result of its increased fibre content. This increased fibre content signifies, also, superiority in another of the five heads which we are investigating, that of furnishing more fuel in the shape of bagasse, since these canes all have from 20 to 30 per cent. more fibre content than the native canes.

A promising solution of the variety problem seemed well on the way and the splendid crop years of 1913 and 1914, while diminishing interest on the part of the planters in these new canes, served all the more to confirm their value and permitted us to increase the plantings in the strategic parts of the province without having to supply the canes in large quantities to the planters *before we were absolutely sure of our ground*, a most necessary caution in Experiment Station work, as premature recommendations often work serious evils and weaken the faith of the agriculturists in the very institutions to which they should accustom themselves to turn for assistance and advice. In these splendid years, 1913 and 1914, while fairly satisfactory yields were obtained from the native canes, *i.e.*, as compared with yields in the past decade, but seldom passing under the very best of conditions 30 tons of cane and sometimes less than three tons of sugar per hectare, *phenomenal* yields were obtained from the Java canes, the J. 213 producing in 1913 *over 100 tons of cane and 11 tons of sugar per hectare*, while the J. 30 persistently maintained yields above 70 tons of cane and seven tons of sugar. The J. 234 only about doubled the native yield of cane, but due to its superior chemical composition, consistently produced two and-a-half

times as much sugar per hectare. The J. 139 demonstrated itself again to be a late maturer but an extremely heavy yielder in the field, in this respect passing the J. 234.

In 1915 the climatic conditions were very unfavourable, and the native cane showed quickly that it had not, as many Tucumán planters had fondly persuaded themselves, regained its pristine vigour. The 1915 crop was considerably less than one-half that of the 1914 one, the yield per hectare being just a little over 50 per cent. that of 1914, but the chemical analysis, due to the early frosts, was very inferior. Nevertheless, not one of the four Java varieties under discussion gave us less than fifty tons per hectare, the J. 213, even under the unfavourable conditions of 1915, again passing the 80 ton mark.

A number of people in Tucumán, who had the previous year bemoaned the fact that high ocean freights caused by the movements of the German raiders on this coast at that time had prevented considerably larger exports of our surplus sugars to the European nations in order to clear the way for the huge crop which was to be made in 1915, now suddenly discovered that they had always opposed the idea of exportation and advised the accumulation of stocks of sugar under warrants from the Government. The outlook for the industry was decidedly bad, for the heavy frosts had done much damage to the stools of the already weakened native cane and the general situation was more serious than it had been for years.

At the Experiment Station and in the substations we had now had five years of experience with the new canes, under almost every climatic condition conceivable for Tucumán, and the results from these five years showed that the native canes had averaged 23 tons of cane and about two tons of sugar per hectare whereas the J. 213 had averaged almost 75 tons of cane and six and-a-half tons of sugar, and the J. 36 and J. 139, 65 and 60 tons of cane per hectare, respectively. The J. 234 had averaged, during the same period and under identical conditions, over fifty tons of cane per hectare, its uniformly high sugar content causing its production of sugar to reach almost five tons per annum. For the four Java varieties, the average annual yield during these five years was 62

tons of cane and well over five tons of sugar per hectare—considerably over double the native cane. Besides the question of cultural yield, we had been able to prove definite superiority on each of the five points we had placed as our objects at the beginning of these investigations. Results had been confirmed also, in later plantings on a large scale and all over the province in the substations. The time had come, therefore, for the Experiment Station to make definite recommendations of these canes for supplanting the native striped and purple ones. Early in 1915, an active propaganda was commenced and has been duly continued up to date, to induce the planters, large and small, to leave off the expensive cultivation of the degenerated native canes and supplant them as rapidly as possible with the vigorous, rapid growing Java ones, following the counsels of the Experiment Station officials as to the best of the Java varieties for their particular conditions of abundance or lack of irrigation water, exposure to frost, type of soil, etc., etc.

With the crop of 1915 a complete failure then, many of the more progressive planters of Tucumán at last put their prejudices and sentiments into their pockets, and began to plant the new canes more vigorously, many of them paying enormous prices for the seed cane to the more progressive men who already had large plantings for these varieties established. Some of these latter men made fortunes through their long-headedness, particularly those who were fortunate enough to have these canes planted in protected situations more or less free from the heavy frosts of the past four winters. When in 1916 the average yield of native cane dropped to only about eight tons per hectare, the prejudices against the foreign invaders in their cane fields almost entirely disappeared, and some 50,000 acres were laid down in these canes, the J. 213 predominating. The comparatively good development of these plantings in the unprecedentedly unfavourable seasons of 1916–17, *when all the native canes practically did not grow at all*, was the straw that broke the proverbial camel's back, and in 1917 everyone fell over themselves to secure seed of the Java varieties, paying almost any price asked, some sales being made at as high a price as 40 pesos per ton (over £3), which is more than twice the price paid

for cane for the mill even in the most critical periods of lack of supply (the actual price of cane in Tucumán to-day is less than £ 1 per ton).

It is most probable that another 60,000 acres were planted in 1917, which figure was very little added to in 1918, due to the frosts being so heavy and so early that extremely little good seed was available. Meanwhile the native cane had almost entirely disappeared, and with it a number of small cane planters have had to turn to other kinds of farming, as the enormous prices of Java seed-cane have been entirely beyond the poor man. It is probable that by the time the 1920 crop is ground the native canes will be looked upon as a curiosity should occasional specimens reach the mills. Such is the peaceful revolution which has taken place in the province of Tucumán, while the struggle was going on "to make the world safe for democracy."

We may safely say, then, that these investigations have saved the Tucumán industry from absolute bankruptcy, for no industry could resist the enormous losses which would have had to be sustained had Tucumán not had within its reach the salvation from the ridiculous yields to which its native canes had dropped, if she had not found her salvation *already waiting for her* when ruin was staring her in the face. It is probable that there is not a case in the history of Experiment Stations, and there are some remarkable chapters in that history, where one of the principal industries of a country has been so radically reconstructed and entirely saved in the short space of seven or eight years. An idea of the magnitude of the reconstruction may be gained from the fact that the "Ingenio Santa Ana," the largest place in the province, in fact the largest factory in South America, had for the crop of 1915 over six thousand hectares of cane (about fifteen thousand acres) not one stalk of which was of the Java varieties. In the two years of my connexion with that company we have entirely renovated these huge plantations with the Java varieties at a cost of over a million and a half dollars, and for the past crop we did not have a single stalk of native cane on all our large estate. In the province of Tucumán in general it may safely be predicted that in the crop of 1919 fully 90 per cent. of the cane which passes through the mills will be of the Java varieties.

There is a very common tendency to consider the work of the Experiment Station as something extremely and luxuriously theoretical, as something interesting but of slight practical application. The work of the young Tucumán Experiment Station may well be used as evidence in refutation of this charge. Let us see for a moment what this one series of investigations may mean in dollars and cents in saving expenditure for the Tucumán planters. And the figures here given are not theoretical ones, but are based on the *actual costs* from thousands of acres of the two classes of cane from the time of planting to that of harvest. It is generally conceded that the native cane, year in and year out, costs just about one hundred *pesos* per hectare (about £4 sterling per acre) in actual cultivation, in fact this has always been the amount universally advanced by the factories to their colonists and *caneros*. The average yield for the native cane, before the last series of disastrous years, has been about twenty tons per hectare. That means, therefore, that the cost of cultivation of the native cane per ton is just five *pesos*. Let us see how this compares with the cost of cultivation of the Java varieties, which are quicker growing and, hence, need less weeding and general cultivation and which yield from twice to four times as much as the native cane. Let us take as a conservative figure only twice the yield of the native cane from these varieties and assume that we will spend 80 per cent. as much in cultivation per hectare, a figure which will never be realized as the Java canes can be cultivated at a much lower rate. This means, then, reduced to cost per ton, that the Java canes cost us for cultivation only two *pesos*, whereas we have been spending five on the native. The Tucumán planters, then, are to-day saving in cost of cultivation at *least three pesos on every ton* of cane they deliver to the *factories*! When the plantations are normalized, which will be for the crop of 1920, Tucumán will grind about 2,000,000 tons of cane annually.

Will not the Tucumán Experiment Station have paid a splendid dividend to its stockholders, the cane and sugar men of Tucumán, when, *as the result of only one series* of experiments, it contributes to the little province a saving in the cost of cultivation of its principal

crop of a round six million *pesos* per year (about £500,000)? Is it not likely that these results will place the province of Tucumán within a few years in a position which will permit her to enormously increase her production and compete under more favourable terms with other countries having vastly superior climatic and geographical conditions ?

THE WORLD'S SUGAR SUPPLIES.*

IN view of the fact that at the close of the year the British Sugar Commission ends its work, and that prices will afterwards be governed by open market conditions, more than usual interest attaches to the reports of the present crop and the estimates of the world's supplies. Indications point to there being plenty of sugar in the world to meet normal requirements, though he would, indeed, be a rash person who went so far as to prophesy a return to pre-war values, or even a substantial reduction in the prices which have steadily risen during the past five years.

The United Kingdom is one of the greatest sugar-consuming countries, and, unlike the majority of others, is entirely dependent upon imports for its supplies. Before the war those imports of cane and beet, refined and unrefined, were rapidly approaching the round figure of two million tons a year. This approximately represents a consumption which was exceeded in bulk only by the United States and British India, with Germany and Russia occupying fourth and fifth positions. The average annual consumption in the five years' period 1908-13 for the world is estimated at 15,850,000 tons, the principal consuming countries being America 3,400,000 tons, British India 2,830,000 tons, United Kingdom 1,800,000 tons, Germany 1,460,000 tons, Russia 1,180,000 tons, Austria-Hungary 680,000 tons, and France 643,000 tons. On the basis of population, the United Kingdom was an easy first in the average consumption per head, with America next. A curious fact is that while the world's supplies averaged nearly 16 million tons a year, the exportable surplus of producing countries averaged only 5½ million tons, of which the United States absorbed 50 per

* Reprinted from *The Economist*, dated 1st November, 1919.

cent., Great Britain 34 per cent., and British India 11 per cent. Notwithstanding that India produced more sugar than any other country, it was not self-supporting, having to import 20 per cent. of requirements, principally from Mauritius, Java, and Austria-Hungary. On the other hand, the United States, with great resources, produced only 23 per cent. of requirements, and imported very largely from the West Indies. Of European countries, Germany, Austria-Hungary, Russia, France and Holland all produced a varying surplus for export.

Before the war the United Kingdom's requirements were supplied to the extent of 96 per cent. from foreign countries, and 4 per cent. from British possessions, fully half of the former being derived from Germany, and a fifth from Austria-Hungary. In 1913, for instance, our net imports of sugar were 1,968,760 tons, of which Germany sent 936,900 tons and Austria-Hungary 358,922 tons—in all, 1,295,822 tons, or just on 66 per cent. of the total net imports. It will be readily gathered that when war cut off these sources of supply the United Kingdom found itself in a very tight position, and had to turn to other quarters to supplement the 34 per cent. left. Cuba, which in pre-war years sent us about 200,000 tons, was appealed to, and increased her export to the United Kingdom to as much as 700,000 tons in 1917, while the British West Indies, Peru and America were all drawn upon for larger quantities. In the circumstances of a world shortage, due principally to the exclusion of German and Austrian sugar, and the difficulties attaching to overseas transport, it could not be expected that normal supplies could be assured. Great Britain, nevertheless, did very well, and managed to import 70 to 75 per cent. of the quantity she might otherwise have imported, as the following returns of net imports will show :—

			Tons	C. I. F. values £
1913	2,969,255	23,066,621
1914	1,984,074	32,013,077
1915	1,480,263	31,862,563
1916	1,529,160	37,271,340
1917	1,386,793	36,685,807
1918	1,306,109	34,368,147

By way of illustrating the increase in value, it may be noted that the average cost per cwt. in 1913 was 11s. 8d. ; in 1918 it had advanced to 26s. 3d. per cwt. Imports to the United Kingdom this year so far show a fair improvement on the previous two years, total to hand in the eight months January–August being returned at 1,123,107 tons, against 908,013 tons and 960,600 tons in the corresponding periods of 1917 and 1918, respectively. Should the remaining four months of the year maintain the same level, we may expect to receive about 1,700,000 tons, or 400,000 tons more than in 1918. Incidentally, it may be said that less than 20,000 tons of this year's imports came from Europe. Cuba, however, heads the list with, in round figures, over 400,000 tons, Java following with 225,000 tons, the United States 150,000 tons, Mauritius 135,000 tons, and the West Indies 92,000 tons.

With regard to future supplies, the outlook is by no means altogether unsatisfactory, the estimates of the present world's crop being about half a million tons above the pre-war average, but about the same quantity below 1917 yield, and 800,000 tons behind last year. In a table printed in the "Commerce Monthly," of New York, for September, the average production of the principal sugar-producing countries in the five years preceding the war, the output of 1917 and 1918, and the estimated yield of the 1919 crop, are given as under in short tons :—

Country	1909-13 (5-year average)	Per cent. of total	1917	1918	*1919
	Tons		Tons	Tons	Tons
British India	2,520,587	14	3,055,360	3,708,320	2,617,000
Germany	2,385,551	14	1,796,390	1,759,047	1,581,000
Cuba	2,050,843	12	3,386,566	3,859,613	4,480,000
Austria-Hungary	1,586,815	9	1,057,840	748,440	784,000
Russia	1,572,136	9	1,480,192	1,152,010	784,000
Java	1,454,540	8	1,787,715	2,005,992	1,870,000
United States	881,734	5	1,133,626	1,010,660	1,040,000
France	751,498	4	206,294	224,297	123,000
Hawaii	554,096	3	644,571	576,839	582,000
Porto Rico	348,456	2	502,395	453,795	420,000
Formosa and Japan	255,249	1	488,349	445,332	466,000
Other countries	3,379,013	19	3,477,234	3,468,565	3,565,000
Total ..	17,740,518	100	19,026,532	19,412,910	18,312,000

* Estimated.

This table only is in short tons ; to translate into long tons, deduct 10·7 per cent., which in the case of the aggregates would give an estimated 1919 production of 16,350,000 long tons, against 17,332,000 tons actual in 1918, and 17,000,000 tons in 1917, and comparing with a pre-war average of 15,850,000 tons. It will be seen that Cuba now leads the way in sugar production, the present crop being equal to 25 per cent. of the world's supply, and at least 100 per cent. more than her pre-war production. Before the war British India and Germany were first and second, respectively, with Cuba third. The dislocation occasioned by the war, however, was responsible for great changes. The cutting off of Germany and Austria-Hungary had the effect of stimulating production in other quarters. British India increased her sugar production in 1918 by 50 per cent. over her pre-war average, and had surplus for export. The present crop appears to have fallen back to about the old level, and if it realizes no more than the estimate, she will have need to import half-a-million tons to meet consumptive requirements. The estimates of the production of Germany and Austria-Hungary approximate to normal home consumption, so that it seems unlikely that either of these countries, upon whose surplus we relied to so large an extent, will have anything of the present crop to export, unless their own peoples deny themselves. The shortage in these two countries represents a difference of 1,460,000 tons in the world's supply. Russia's crop is put down at half pre-war average, and equal to about 50 per cent. of Russia's normal consumption, while France, which previously was self-supplying and had a small surplus of 30,000 to 40,000 tons for export, will have to import about 600,000 tons. In other words, Europe, including the United Kingdom, will require over six million tons of sugar and will produce only half that quantity. The falling off in European production is, however, offset by the greater outturn of Cuba, as already noted, by Java, the United States, Japan, and others who have increased their crops. It may be added that the Royal Commission on Sugar co-operating with the American Food Administration, formed an International Sugar Committee, and arranged to buy the entire Cuban crops of 1917-18 and 1918-19, the United States taking about

two-thirds of the production, and the Royal Commission the remaining third.

The extent to which sugar from beet has played a part in the world's sugar supplies may be seen in the fact that in the five-year period preceding the war it amounted to 45 per cent. ; this year it is estimated at only 27 per cent. Owing to our drawing so largely upon Germany and Austria-Hungary, our nearest sources of supply, about two-thirds of the sugar consumed in the United Kingdom in other days was beet sugar. Latterly, owing to the change in the sources of supply, it has been preponderatingly cane sugar, the production of which by places within the British Empire increased from 3,275,500 tons in 1913-14 to 4,384,100 tons in 1917-18. when it formed one-fourth of the world's supply. Germany, her export market gone, had, according to the President of the German Industrial Sugar Users, an area under beet in 1918 of only 367,000 hectares (hectare equals 2·47 acres), as against 569,000 hectares in 1914, or roughly a decrease of 35 per cent. In Austria-Hungary the area under beet decreased 50 per cent. Europe is, of course, the great sugar beet-growing centre, and the future of its crops and their influence on sugar production elsewhere will be followed with the keenest interest. Will the industry revive in Germany and Austria-Hungary and assume pre-war extent, or will the dislocation which the war occasioned, and the development of cane sugar-growing prove too heavy a handicap? In other words, will beet sugar successfully compete with cane sugar? Recently it was stated at a meeting of the British Society of the Chemical Industries that the British Empire, with about 3,500,000 acres under sugar mostly cane, produced less than Germany and Austria-Hungary combined from less than half that area under beet. Of course, Germany, since it wrested the lead from France after the Franco-German war, had made great progress in improving the sugar content of the beetroot, which in the early days of the industry was only 6 to 8 per cent. While it is said the roots of the 1909 harvest contained an average of 17·63 per cent.

Efforts have been made in this country to induce farmers to grow beet for sugar, but in view of the cheapness of imported sugar

it has not been demonstrated to be a sound commercial proposition. Apparently the United Kingdom has a long way to go before it can establish a successful beet sugar industry. A regular supply of roots and co-operation between grower and manufacturer would appear to be essential, and not less important the cultivation of the beet to ensure the highest standard of quality. Investigation of 375 samples of sugar beet grown in the United Kingdom proved them to be in composition and purity above the average of those grown on the Continent, but it was reported that in other respects British-grown roots were so defective that it would be impossible to deal with them in a factory. The report of the society added that "until greater attention is bestowed on the culture of sugar beet it cannot be asserted that sugar beet can be grown in the United Kingdom equal to those furnished on the Continent."

Sweden, by the way, is successfully cultivating sugar beet, the area under beet this year being 36,034 hectares, or 14 per cent. greater than in 1918. With an average harvest it is anticipated that this year's production will suffice to meet most of Sweden's needs.

BOTANY AND ITS ECONOMIC APPLICATIONS IN THE EMPIRE.

At the last meeting of the British Association at Bournemouth, Sir Daniel Morris, President of the Section of Botany, in the course of his opening address,* said:—

There can be no doubt that not only in the West Indies but also in all parts of the Empire, “Enlightenment as to the objects, methods, and conditions of scientific research is proceeding at a rapid rate.” Perhaps the most interesting feature of the progress made is in connection with the application of the laws of heredity to the improvement of such highly important crops as sugar, wheat, and cotton. The problems associated with these involve both scientific and economic considerations. As regards the scientific side, it is fortunate that with the beginning of the twentieth century came the rediscovery of Mendel’s facts and the stimulating energy of the genetic school which has brought us an entirely new point of view in regard to the increased production of field crops.

Great importance is attached to the improvement of the sugarcane, as the prosperity of many of our possessions depends upon it. Further, the requirements of this country approach something like 2,000,000 tons per annum. The sugarcane, although its origin is unknown, has been cultivated in tropical and sub-tropical countries from remote ages. Up to a recent date its propagation was purely vegetative, as it was supposed to have lost the power of producing mature seed.

Sugarcane seedlings were observed at Barbados in 1858, but it was only in 1888 that Bovell and Harrison were in a position to utilize the discovery and obtain thousands of self-sown seedlings for experimental purposes. Similar seedlings were also available in Java about the same time. As about this period the standard

* Reprinted from the abridged report in *Nature*, dated 11th December, 1919.

canes in sugar-growing countries were showing signs of being severely attacked by disease, the discovery of seedlings was a fortunate circumstance. In fact, in some cases it may be regarded as having probably saved the industry. In British Guiana it is reported that in the crop of 1918 seedling canes occupied 83 per cent. of the total area under canes. Similar results have been obtained at Barbados, where Bovell has continued since 1888 raising canes of great merit.

In India there is probably a larger area under sugarcane than in any other country. Its production of sugar is more than 2,000,000 tons. The larger proportion of this consists of a low-grade quality known as *jaggery* or *gur*. Palm-sugar is also produced to the extent of 500,000 tons. Speaking generally, the sugar industry in India is not in a satisfactory condition. In spite of the enormous area under cultivation, India is obliged to increase its considerable imports of sugar from Java and other countries. To obviate this, urgent steps are being taken to improve the character of the canes and establish varieties adapted to local conditions and the circumstances of the sugar-growers.

In the considerable literature of sugarcane-breeding in India Barber has brought together a vast amount of information of singular interest and value. In the few years that have elapsed since he has been in charge of the Coimbatore Research Station he has laid the foundation of lines of inquiry that cannot fail to prove of great value in the permanent improvement of the sugar industry in India.

In his presidential address in 1898 Sir William Crookes stated that the prime factor in wheat production was a sufficient supply of nitrogen. As the supply was then showing signs of exhaustion he warned wheat-growers of the peril awaiting them. Sir R. H. Rew has now shown that, thanks to the chemist, who came to the rescue, there is practically no limit to the resources of nitrogen. During recent years Biffen, by his successful investigations on Mendelian lines at the Plant Breeding Institute at Cambridge, has shown that the characteristics distinguishing the numerous wheats can be traced, and the building up of a fresh combination of these

characters was possible on practical lines. As the losses caused by disease were so serious, sometimes running to millions of quarters annually, Biffen devoted special attention to the possibility of breeding rust-resisting varieties. He found that the power of resisting the attacks of yellow rust, for instance, was an inheritable character. By crossing Gurka, a Russian disease-resisting wheat, with Square Head's Master, one of the most widely cultivated wheats in this country, Biffen eventually produced Little Joss, which, after trials extending over a period of several years, is said to yield four bushels per acre more than any other variety. Further, it possesses distinct disease-resisting qualities.

Another of Biffen's new wheats is Yeoman. This was raised in order to produce what are known as strong wheats. These are in great demand in this country, as they produce a flour which is much superior for baking purposes to the flour of English wheat. In pre-war days Canadian strong wheats commanded in the market 5s. more per quarter than the best English wheat. Yeoman not only possesses the superior quality of Canadian wheat, but combines with it the high-yielding character of certain English wheats.

A well-authenticated report, supplemented with full details, of the value of Yeoman as a field crop, was lately published (*Journ. Bd. Agric.*, Vol. XXV, 1161). It was cultivated under normal conditions, but without artificial manure, on three fields on a large farm near Wye, Kent. The cropped area was a little more than twenty-seven acres. The total yield was 2,072 bushels, or an average of about seventy-seven bushels per acre. One field, previously under beet, comprising three acres, two rods and eight poles, yielded 340 bushels, or an average of eighty-six bushels per acre. These results may be compared with thirty-two bushels, the average yield of wheat in this country.

A most desirable improvement in wheat-growing in this country is to obtain a spring wheat combining early maturity with a yield approaching that of winter wheat. The establishment of a National Institute of Agricultural Botany for the further development of plant-breeding and the distribution of pure seed may be regarded as essential to the welfare and safety of the nation.

Wheat-growing is a very important industry in India. It was estimated in 1906-7 that 29,000,000 acres were under cultivation in wheat with a yield of nearly 9,000,000 tons. Of this 90 per cent. was consumed in India. A botanical survey of the Indian wheats was undertaken by the economic botanists at the Imperial Research Institute at Pusa in 1910. In the following years, by the application of modern methods of selection and hybridization high-grain qualities were successfully combined with high-yielding power, rust resistance, and stiff straw, so that wheats were produced which gave upwards of forty-one bushels per acre.

Among the best of the new varieties are Pusa 4 and Pusa 12. Owing to an organized system of distribution of seed, it is estimated that the area under Pusa 12 during the last wheat season (1918-19) was about 400,000 acres. The area under Pusa 4 was about 100,000 acres.

The important work carried on at Pusa by Howard and his accomplished wife has followed closely on the methods found so successful at Cambridge. It is interesting to note that in obtaining new kinds by hybridization between Indian wheats and rust-resisting forms in Northern Europe a difficulty in regard to flowering at different periods was overcome by sending the Indian parents at Cambridge for spring sowing and by carrying out the actual crossing with Biffen's new hybrids in England. From the crosses thus obtained Howard reports that a wide range of wheats has been evolved likely to prove superior to Pusa 4 and Pusa 12.

The admirable work done by Biffen at Cambridge and the Howards in India clearly demonstrates the value of thorough acquaintance with pure botany as a qualification for grappling with questions of economic importance.

In reviewing the gain to Indian wheat-growers the Director of the Agricultural Research Institute has recently stated that, in view of the favour with which the new wheats have been received and the cordial co-operation of provincial organizations, "it is a modest estimate to assume that in course of a very few years the area under Pusa wheats will reach 5,000,000 acres. This means an increase, in the near future, in the value of the agricultural produce

of India, in one crop only of 75 lakhs of rupees or £5,000,000 sterling.”

As in wheat, so in cotton, this country is almost entirely dependent on foreign supplies. The uneasiness caused by the excessive dependence of the great Lancashire cotton industry, with exports of the annual value of more than £100,000,000 sterling, on supplies from abroad, and the occasional shortage, have led to general action being taken to encourage the more extensive growth of cotton within the Empire. Next to the United States, which in some years has supplied seven-tenths of our imports, India comes second, but the East Indian cotton is not well suited to the requirements of the English spinner. Egypt, as the third producing country, supplies cotton of great strength and fineness.

The most valuable of all cottons is that known as Sea Island cotton, owing to its introduction and successful cultivation on the coastal areas in South Carolina, Georgia, and Florida. It is interesting to report that in recent years Sea Island cotton has been introduced back again to the West Indies, which was probably its original home. This was effected by the Imperial Department of Agriculture in the West Indies in 1902, when a pure strain of seed raised from plants immune to wilt disease was obtained in quantity from James Island. This ensured that the industry from the first was placed on a firm basis, and, with the hearty co-operation of the planters, an important West Indian cotton industry was successfully established. For some years the West Indian cotton has obtained a higher price than the corresponding grades of cotton from the Sea Islands themselves. The fine spinners in Lancashire are now practically independent for their supplies of this cotton from the United States. Further, it is not improbable that, owing to the serious attacks of the Mexican boll weevil on cotton plants in South Carolina and Georgia, the West Indies may become the only source of supply of fine Sea Island cotton. The results so far attained may be realized from the fact that the West Indies in recent years has reached a total of £2,000,000 sterling. The general conditions in the West Indian islands, owing to their small size and comparative isolation, should enable them to maintain a high purity of cotton. Harland,

whose services in the West Indies have been provided by a grant from the Imperial Department of Scientific and Industrial Research, has in hand important investigations with the view of placing the work of cotton selection and breeding on scientific lines. He has shown that the yield of lint per acre depends on a number of factors of a morphological and physiological character. In a general way it may be said that the yield is dependent on the climatic conditions, so an effort is being made to produce varieties which will interact with the environmental conditions to the best advantage. Although Harland's work so far is of a preliminary character, he is able to suggest the conclusion that, following certain lines of selection and breeding and bearing in mind the relative importance of lint index and lint percentage, it is possible to isolate a strain of Sea Island cotton with a weight of lint per boll 31 per cent. greater than that of the ordinary sorts in cultivation.

As already mentioned, India is the second largest producer of cotton. In 1906-07 it was estimated that there were about 20,000,000 acres under cotton with a production of nearly 5,000,000 bales. It is unfortunate that the quality of East Indian cotton is not high, in spite of the considerable efforts made in recent years to improve it.

Leake's research work in the United Provinces, carried on for many years, is regarded as probably the most complete yet attempted with cotton in India. A variety known as K. 22 has been widely distributed, and the produce in 1916 sold at 31 rupees per maund when local cotton was 25 rupees. Further, the ginning percentage has been raised from 33 to about 40, while the lint is of superior quality.

Leake has also been successful in raising an early-flowering form of cotton on Mendelian lines. The new form differed from ordinary cotton cultivated in the United Provinces in that it assumed a sympodial instead of a monopodial habit. It not only yielded cotton of high quality, but was found by its early-flowering habit to suit the special conditions of the United Provinces.

As Egyptian cotton comes next to Sea Island cotton in quality, it may be useful to refer to what has been done, or attempted to be

done, on scientific lines to safeguard the industry. Its importance may be gathered from the fact that the area under cultivation is between 1,500,000 and 2,000,000 acres. Balls has fully reviewed the scientific and other problems that had to be solved in placing the industry on a satisfactory footing. According to Balls, the high-water mark of Egyptian cotton-growing was from 1895 to 1899. Since that time, although the actual area under cotton has been increased by 600,000 acres, the benefit measured in terms of cotton alone has been small. It is probable that the attacks of the pink boll-worm and other pests may have affected the results, but Balls and his colleagues drew the conclusion that "the falling off in yield was due to a rise in the level of the subsoil water or water table of the country brought about by the extension of the irrigation system during the past decade." The roots of the cotton plant were thus adversely affected at a critical period of growth. This recalls what Howard discovered: that one of the causes of the wilt disease in indigo in India was the destruction of the fine roots and nodules during heavy monsoon rains.

Probably the most remarkable instance on record of the successful combination of science and enterprise in the tropics is the establishment of a cacao-growing industry in the Colony of the Gold Coast, West Africa. Thirty years ago no cacao of any kind was produced on the coast. Owing, however, to the foresight of the then Governor (Sir William Brandford Griffith), who sought the powerful aid of Kew, cacao-growing was started in a small way among the Negro peasantry with eventually extraordinary results. After selecting the locality for the experiments, seeds and plants were obtained through Kew, and a trained man was placed in charge (*Kew Bull.*, 1891, p. 169; 1895, p. 11). The first exports in 1891 amounted to a value of £4 only. So rapid was the development of the industry that ten years later the exports reached a value of £43,000. By this time both the people and the Government had begun to realize the possibilities of the situation, and systematic steps were taken to organize under scientific control a staff of travelling agricultural instructors to advise and assist the cultivators in dealing with fungoid and insect pests and improving the

quality of the produce. In 1911 the exports had increased nearly fourfold and reached a total value of £1,613,000, while in 1916 what may possibly be regarded as the maximum exports were of the value of £3,847,720.

It should be borne in mind that this Gold Coast cacao industry, now one of the largest in the world, has been called into being and developed entirely by the agency of unskilled Negro labour, and on small plots from one to five or ten acres in extent. The controlling factors were, first, the selection of suitable land for cacao-growing; next, the selection and supply of seeds and plants of varieties adapted to local conditions; and, lastly, the advice and assistance of trained Europeans backed by the resources of science.

Coming nearer home, Henry, well known from his association with Elwes in the production of "The Trees of Great Britain and Ireland," by historical research and experiment, has established the fact that many fast-growing trees in cultivation, such as the Lucombe Oak, Common Lime, Cricket-bat Willow, Black Italian Poplar, Huntingdon Elm, etc., are natural hybrids. It was of high scientific importance to discover the origin of these valuable trees. Further, by artificial pollination, Henry has succeeded in raising new hybrids which display the extraordinary vigour characteristic of the first-generation cross. Perhaps the most notable so far is a new hybrid poplar (*Populus generosa*) which makes the strongest shoots of all poplars. It is claimed in the case of hybrid trees that "it is possible to produce much greater bulk of timber in a given time." The common belief that quickly grown timbers are of inferior quality is said not to hold good in respect of any quality in ash, oak, and walnut. In fact, according to Dawson, "with oak, ash, and walnut the quicker their growth the better their quality in every way. They are more durable, more elastic, and less difficult to work" ("Science and the Nation," p. 138). It is further claimed that by hybridizing it may be possible to produce disease-resisting varieties and varieties carrying with them other desirable characteristics.

In the tropics breeding experiments in the case of India-rubber trees are likely to prove of great value. In the meantime, selection

of seed from the best trees is being carefully carried out in the hope of increasing the general yield of the plantations. In Java the proportion of alkaloids in the bark of introduced cinchona trees (yielding quinine) has nearly doubled by careful selection on these lines.

Plant-breeding experiments with India-rubber trees have already been attempted, but they are not likely to be of much value if they are confined to empirical and haphazard lines. Work of this kind must be lengthy and complex, but it is absolutely essential to ensure the safety of an industry which is estimated to be of the annual value in the Middle East of about £50,000,000 sterling. The Agricultural Department in Ceylon, which is fully alive to the fundamental importance of the selection and breeding of India-rubber trees, has already taken some action in the matter.

Another investigation in hand is to determine whether the latex-yielding quality of *Hevea* trees can be associated with any definite botanical characters and to what extent such characters are transmissible. Twenty trees of the same age growing in a four-acre block have been selected for differences in leaf and bark characters. These are all tapped on the same system, and the yield of rubber from each tree is recorded separately for each tapping (*Kew Bulletin*, 1917, p. 118).

The value of these and other experiments of a like nature may be realized when, according to Varnet, quoted by Johnson, the yield of rubber from different trees of *Hevea* growing under similar conditions in the same plantation may vary as regards volume of latex from 4 to 48, and in percentage of weight of dry rubber from 1.286 to 14.164 (*Journ. d'Agric. Tropicale*, 1907).

Bateson a few years ago expressed the opinion that nowhere is the need for wide views of our problems more evident than in the study of plant diseases. Biffen and others have shown that under certain conditions the quality inherent in some varieties to resist disease may be utilized to great advantage. The national importance of such work is impressed upon us by the enormous losses sustained every year by rust in wheat, mould in hops, and the widespread disease of potatoes. One of the most striking instances

in recent times was the destruction of the valuable coffee plantations in Ceylon. The industry, an exceptionally valuable one, was wiped out in a comparatively few years by the coffee-leaf disease (*Hemileia vastatrix*). In the light of our present knowledge it is not improbable that this disease may have been checked by seed selection or by raising an immune race of plants or, more probably, as suggested by Armströng, by regulating the use of essentially nitrogenous manures, which are known in some cases to intensify the attacks of fungoid pests, and substituting the use of phosphates. As illustrating the occurrence of an incidental result arising from a purely scientific investigation, mention may be made of the discovery of a remarkably tall strain of flax at the John Innes Institution. This, if capable of being established on pure lines, may prove of economic value. It is a hopeful sign that the appreciation of the work done at this institution, under the stimulating energy of Bateson, is increasing day by day. We may mention the great success which is attending the establishment of a school of technical education and research by the Royal Horticultural Society at Wisely. This is maintained by liberal funds, and by means of its well-equipped laboratories and extensive trial grounds it offers unique facilities for solving problems of great value as affecting the future of British horticulture. In sympathy with the work at Wisely, private firms are also setting up laboratories of their own and employing men of high standing so that a just balance may be maintained between science and practice. The progress made in the elucidation of problems in tropical plant pathology shows the necessity not only for well-trained and experienced mycologists and entomologists, but also for the correlation and combination of knowledge gained in their several lines of study. It is suggested that research work should be organized on the broadest possible lines, and combine the biological services of the whole Empire. We have a first step in this direction in the Imperial Bureau of Entomology, with its headquarters at the British Museum. Those acquainted with the efficient work done by this bureau and the excellent publications issued by it will very heartily welcome the establishment of the proposed Imperial Bureau of Mycology to carry on work on similar lines.

Notes

HALF-BRED AYRSHIRE-MONTGOMERY CATTLE AT PESHAWAR.

IN January 1917, two half-bred Ayrshire-Montgomery bull-calves were placed with the Awankari herd at the Peshawar Agricultural Station, to observe their thriftiness in general, and their resistance to diseases which are never long absent from the neighbourhood of the farm. A third calf was at the same time given to a neighbour in a village near by, there to be observed, whilst taking his chance of life with the village cattle. The half-bred animals were brought up on the pail. The pair on the farm were fed whole milk, with a little concentrated food in season. Reared in this way they of course cost more to bring up than they were likely to realize as work-bullocks, but they grew into big, blocky, strong-limbed, and quite exceptionally good handsome bulls. They were never sick or sorry until they attained the age of two years. Then rinderpest carried off No. 1, when that disease was abroad in the land. But happily, no Awankari or working bullock in the Tarnab herd of about 60 animals was attacked. The cross-bred No. 1 was the first to succumb to the disease. No. 2 was not affected when his stable companion died. The entire herd was inoculated when cross-bred No. 1 was seen to be ailing and the usual precautions were taken to prevent the spread of the disease when the case was diagnosed.

Now, four months after the death of No. 1, No. 2 has "foot-and-mouth." The trouble is prevailing in the neighbourhood, but thus far no Awankari or working bullock is affected. So the half-bred is banded the herd, and soon he will go to the butcher. An animal that is peculiarly liable to disease is a danger to all the herd.

No. 3 early saw the desolation of rinderpest. When he was less than three months of age, the writer observed him, and in sympathy rubbed his poll, as he awaited inoculation amidst many cattle in the village, a village where, the week before, 40 head succumbed to rinderpest. He came through that trial unaffected. And although foot-and-mouth is in the villages off-and-on nearly always, he escaped that also without in any way foregoing his freedom or the companionship of reputedly hardier kine.

But he is dead now. His owner became ashamed of him, for he was a dwarf. He was hardly more than half the size and weight of his half-brothers on the farm who were much of his age, but who had the good fortune to be brought up on whole milk and good Agricultural Station rations. He was not a pinched starved dwarf. He was a sleek little "Tom Thumb."

So ends the small trial of half-bred cattle at Tarnab.

Knowing the heavy toll rinderpest and other diseases have taken from imported bulls and their half-bred progeny in India, and bearing in mind that foot-and-mouth especially is never long absent from the villages, more than ever the utmost will be done at Tarnab to raise the milk yield of the Awankaris by *selection*, rather than by an *infusion of foreign blood*.

The work bullock whose upbringing costs Rs. 150 or more must not be more than usually prone to suffer from the diseases that so frequently visit the villages.

Regarding the thriftiness of cross-breds and Awankaris respectively, on nearly level terms they did equally well. Up to the age of two years, which was the period of the trial, the Awankaris, age for age, were as heavy as, and far more handsome and active than, the cross-breds (Plate XIV).

But the loss of the two cross-breds at Tarnab is regretted. They got a lot of kind handling and Plate XIV shows that they responded to good fare and kindness.

The trial was of course *quite* a small one. But soon, perhaps, records of the progress of the big herds of half-bred cattle that are now in India will be published. [W. ROBERTSON BROWN.]



Awankari.

Ayrshire-Montgomery.

THE BRITISH EMPIRE SUGAR RESEARCH ASSOCIATION.

WE have received the following for publication :—

THE need for a British Sugar Research Association has so long been felt by sugar planters, refiners and all those manufacturing firms directly and indirectly concerned with sugar, that the formation of such an association as has now come into being will be welcomed.

With the assistance and support of the Government Department of Industrial and Scientific Research, a strong association has now been formed, whose memorandum and articles of association, and prospectus, have received the approval of that department, as well as that of the Board of Trade. On 30th May, 1919, this association was registered under the presidency of Sir George Beilby, who is a member of the Advisory Council of the Government Department of Industrial and Scientific Research. The Vice-Presidents are the following distinguished gentlemen:—the Rt. Hon. Lord Bledisloe of Lydney, K.B.E. ; Sir Daniel Morris, K.C.M.G., D.C.L., D.Sc., LL.D. ; Sir Edward Rosling ; Professor E. J. Russell, O.B.E., D.Sc., F.R.S. ; Professor W. Bateson, D.Sc., F.R.S. ; Professor J. Bretland Farmer, D.Sc., M.A., F.R.S. ; and Mr. Edward Saunders.

The gentlemen elected to the Council represent every branch of the sugar industry throughout the Empire.

The aim of the association is to establish, in co-operation with the Government Department of Scientific and Industrial Research, an empire scheme for the scientific investigation, either by its own officers, or by universities, technical schools and other institutions, of the problems arising in the sugar industry, and to encourage and improve the technical education of persons who are or may be engaged in the industry.

The association is inviting all those who are engaged in any branch of the sugar industry within the empire to become members, and thus become eligible for benefits resulting from the scientific investigations it will carry out.

While it may be admitted that research work has always been proceeding in scattered localities of the empire, where cane and beet

are grown, and also in England where sugar is refined, as well as in factories where sugar is an ingredient for the manufacture of the finished article, such research is carried out by the factory's chemist, who works continually for the improvement of sugar manufacture. Such improvements, however, often remain only half investigated, owing to the time given to routine work, which is the main occupation of the factory chemist. There are few factories who can employ a highly skilled chemist mainly for research work, therefore the necessity for an organized association where research will be carried out by the best brains, for the general benefit of the empire sugar industry, is felt daily more and more.

The scope of the work to be done by the association will include the investigation of problems arising in all branches of the sugar industry, including the improvement of the sugarcane, sugar beet, the various methods of extracting the sweetening matter from cane and beet, the various processes of refining, and the best methods for the use of sugar employed by manufacturers using sugar as one of their raw materials, as well as the discovery of the best uses of the after-products of both factory and refinery.

In order to make the research work of the association of the greatest possible utility to the industry, power has been taken, not only to encourage the training of research workers, but also to improve the technical education of persons engaged, or likely to be engaged, in all branches of the sugar industry.

A survey is being made of the field of research which is likely to be beneficial to the industry, and it is hoped that members of the association will be willing to assist in the framing of a thoroughly comprehensive scheme, by making suggestions relating to that part of the industry with which they are intimately acquainted.

It is also proposed to establish a bureau of information for the sugar and allied trades industries, to which any member of the association can apply for assistance in the technical and other difficulties which he may encounter in his business.

By means of its various activities as an association for sugar research, a bureau of information, and a centre for the furtherance

of technical education, it is hoped that the British Empire Sugar Research Association will exercise a far-reaching and beneficial influence on the future welfare of this ancient and important industry.

* * *

THE ELECTRICAL TREATMENT OF SEEDS.

DURING the past seven or eight years, experiments have been in progress upon the effect of the electrical treatment of seeds. The process is one devised by Dr. Charles Mercier who, however, recently died, but the work is being carried on by others. It is only during the past three years that the process has been worked on a commercial scale. Three seasons ago it was tried at home by about a dozen farmers, two seasons ago by more than 150, and this season by more than 500. The process has not been advertised and the rapid progress made is almost entirely due to the recommendation of one farmer to another, or by seedsmen to farmers. It is claimed for the process that properly conducted electrification of seed never fails to produce an increase in a crop of corn, and that in every one of the few cases in which this result has not been produced, it has been found that some mistake has been made in the process. From samples of wheat, oats, barley, etc., the writer has seen there is a distinct improvement in that grown from electrified seed over that grown from seed in the ordinary way. The figures given to him were that the increase in yield varies from four bushels to twenty or more bushels per acre, the average of a considerable number of trials being about ten bushels or 30 per cent. Engineers indicate that there is considerable difference of opinion and in some cases scepticism as to the results of electrification. It seems a curious fact that laboratory experiments at the experimental farm at Rothamsted shew no improvement from electrified seed, whilst a number of farmers from the Devonshire district are ready to speak in high praise of the value of the process. The owners of the process say that every kind of seed requires its own peculiar treatment, and that this treatment has been completely ascertained only for cereal crops. Large quantities of electrified root seeds have, however, been sown this season. The general claims are that the cost of

electrification is small, the process is simple and adds nothing to the labour of the farmer, to the implements for operation on the farm or to his capital on outlay, unless he chooses to electrify the seed for himself. [*Indian Industries and Power*, November 1919.]

* * *

Flour from the cattails of the swamps has been found by the Plant Chemical Laboratory at Washington to contain about the same amount of protein as rice and cornflours, with somewhat less fat than wheat flour, and it was regarded as a promising substitute with wheat flour to the extent of 10 to 20 per cent. In the investigation of which he has given an account in the "Scientific Monthly," Prof. P. W. Claassen tried the flour in several ways, both as part substitute with wheat flour in baking and as cornstarch substitute for puddings. Biscuits containing 50 and even 100 per cent. of this flour proved to be palatable, not very different from those of wheat flour alone, while the puddings had an agreeable flavour and were satisfactory. The flour material is obtained from the large underground rootstalks or rhizomes, of which it forms a starch core three-eighths to one-half inch in diameter. The dried rhizomes from an acre of cattails were shown to equal 10,792 pounds, and the core substance, passed through a meat-grinder and sifted, yielded fine flour at the rate of 5,500 pounds per acre. Many thousand acres of cattail marshes are included in the 139,855 square miles of swamp-land of the United States. [*Capital*, dated 10th January, 1920.]

* * *

MANGO HOPPER PEST.

A COMMUNIQUÉ issued by the Publicity Bureau, Madras, says :—
THE Government Entomologist of the Agricultural College, Coimbatore, notifies that he is in a position to supply fishoil rosin soap at the rate of R. 0-2-1 per lb. This should be used to spray mango trees to save them from the mango hopper. A pamphlet containing instructions showing how the soap should be applied,

will be sent free of charge to any tree owner who applies to the Government Entomologist, Agricultural College, Coimbatore. The tree owners living in Northern Circars can obtain the soap and the pamphlet by applying to the Deputy Director of Agriculture, No. 1 Circle, Anakapalle.

A later communiqué from the same source says :—

One of the worst enemies of the mango tree is the insect called “the mango hopper” which causes considerable damage to the crop in certain years, especially in Chittoor and Salem. Sometimes the trees in the gardens blossom in profusion during the cold weather, and great hopes are entertained of a good crop in the coming season. But within a week or two after blossoming, the flower buds and blossoms turn brownish and gradually wither away. The few first formed fruits drop and the leaves of the mango become covered with a sticky juice which gives them a dark sickly appearance. The cause of the trouble is the mango hopper.

The mango hopper is a small insect about an eighth of an inch in length with a broad head and a wedge-shaped body. Its colour appears to be a light greenish brown. Close observation shows that it is really brown with light black and yellow markings. It can fly but generally moves about by vigorous hops. The insect lays its eggs in the shoots and leaves, inserting them one by one beneath the surface. The eggs are almost too small to be seen by the eye. The young are similar to their parents but wingless. They cast their skins periodically and get their wings and their full adult form in about 10 days. Both the young and the full-grown insects attack the tender shoots and leaves of the mango and suck up the plant sap, thereby robbing the flowers and fruit of the juice required to develop them. These insects breed at the time when the mango trees blossom, and in some years enormous swarms of mango hoppers may be found in the mango trees at the blossoming season. If these swarms are allowed to have their way there is no hope for the mango fruits.

The only generally effective method of defeating the attacks of mango hopper is to spray the trees at the breeding season with some liquid which will kill the young hopper. Young hoppers

are wingless and are unable to fly or hop. Hence they are unable to escape from the poisonous spray. The spraying operation must be begun when the flowering shoots begin to appear, *i.e.*, about January, and must be repeated from time to time up to the end of March. The possibility of defeating the attacks of the mango hopper by the use of a spray has been tested and proved by the Agricultural Department in experiments conducted for some years in the mango gardens of Salem and Chittoor.

The Agricultural Department has published a leaflet (No. 3 of 1917) giving detailed instructions for the use of the spray. The material recommended by the Agricultural Department for use as a spray is the fishoil rosin soap. To use the spray we need a good syringe which will wet the tree evenly all over. An ordinary garden syringe is not generally satisfactory and a special syringe is required.

The cost of a suitable syringe would probably be about Rs. 100. The cost of fishoil rosin soap required for spraying a single mango tree may roughly be taken as 8 annas. A single syringe will of course spray a very large number of trees. As the crop of a single mango tree may be worth 200 or 300 rupees, it will be seen that the tree owner can well afford to invest some money in a suitable syringe and the fishoil rosin soap. It has been suggested that traders or co-operative societies in Chittoor and Salem might well buy suitable syringes and hire them out at reasonable prices to the tree owners in their neighbourhoods. The Government Entomologist of the Agricultural College, Coimbatore, has already notified that he has a stock of fishoil rosin soap for sale and that he is prepared to supply with the soap pamphlets containing instructions for its use and advice as to the most suitable spraying machines for the work and the firms and prices at which they can be purchased.

It is understood that many tree owners have shown their willingness to adopt the system of spraying, and it might be worth while for a commercial firm to stock and advertise a suitable mango syringe after consulting the Agricultural Department and obtaining its approval to the type of syringe.

PERSONAL NOTES, APPOINTMENTS AND TRANSFERS, MEETINGS AND CONFERENCES, ETC.

SIR FRANK SLY, K.C.S.I., I.C.S., who officiated as Inspector General of Agriculture in India from 1904 to 1907, has been appointed Chief Commissioner of the Central Provinces. We offer him our sincere congratulations.

* * *

WE offer hearty felicitations to the Hon'ble Mr. H. R. C. Hailey, C.I.E., I.C.S., Director of Land Records and Agriculture, United Provinces, and Mr. Frank Noyce, I.C.S., Controller of Cotton Cloth, who have been appointed Commanders of the Most Excellent Order of the British Empire (Civil Division) for services in connection with the war.

* * *

THE New Year's Honours List contains the following names which will be of interest to the Agricultural Department :—

Rai Bahadur. Babu RAJESWAR DAS GUPTA, Deputy Director of Agriculture, Bengal.

Mr. LACHMI CHAND SHARMA, M.R.A.C., Deputy Director of Agriculture, Eastern Circle, United Provinces.

Khan Sahib. Shaikh MUHAMMAD NAIB HUSSAIN, Superintendent, Sugarcane Farm, Shahjahanpur, United Provinces.

M. NAIZ MUHAMMAD, Deputy Superintendent, Civil Veterinary Department, United Provinces.

Rai Sahib. Babu APURBA KUMAR GHOSH, Sericultural Superintendent, Bengal.

Rao Sahib. M. R. Ry. T. S. VENKATRAMAN, B.A., Acting Government Sugarcane Expert, Coimbatore.
M. R. Ry. Y. RAMACHANDRA RAO, M.A., F.E.S., Entomological Assistant, Agricultural Department, Madras.

*
* *

SIR THOMAS ELLIOTT, Bart., K.C.B., has been appointed as the representative of the United Kingdom, India, and other parts of the British Empire on the Permanent Committee of the International Institute of Agriculture at Rome.

*
* *

MR. G. P. HECTOR, M.A., B.Sc., Economic Botanist, Bengal, has been appointed to officiate as Imperial Economic Botanist, Pusa, from 20th December, 1919, *vice* Mr. A. Howard, C.I.E., M.A., on combined leave.

*
* *

DR. F. J. F. SHAW, Second Imperial Mycologist, has been granted combined leave for 11 months.

*
* *

THE University of Calcutta has conferred the degree of D.Sc. (in Chemistry) on Mr. J. Sen, Supernumerary Agricultural Chemist, and the degree of M.Sc. (in Chemistry) has been conferred on Mr. N. V. Joshi, First Assistant to the Imperial Agricultural Bacteriologist, by the Bombay University.

*
* *

MR. T. F. MAIN, B.Sc., Deputy Director of Agriculture, Bombay, has been allowed an extension of furlough for six months.

*
* *

MR. K. HEWLETT, O.B.E., Principal, Bombay Veterinary College, has been granted combined leave for six months. Mr. M. H. Sowerby officiates as Principal during Mr. Hewlett's absence.

MR. R. D. ANSTEAD, M.A., Deputy Director of Agriculture, Planting Districts, Madras, has been granted combined leave for one year from or after 10th April, 1920. Mr. F. R. Parnell, B.A., Government Economic Botanist, will, on return from leave, be entrusted with the supervision and control of the experimental work at the planting stations.

* * *

MR. H. M. LEAKE, M.A., F.L.S., Offg. Director of Agriculture, United Provinces, has been nominated a member of the Legislative Council of the Lieutenant-Governor of the United Provinces.

* * *

DR. A. E. PARR, M.A., B.Sc., Deputy Director of Agriculture, Western Circle, United Provinces, was on privilege leave from the 11th October, 1919, to the 5th January, 1920.

* * *

MR. D. CLOUSTON, C.I.E., M.A., B.Sc., has been confirmed as Director of Agriculture, Central Provinces.

* * *

MR. R. G. ALLAN, M.A., Principal, Agricultural College, Nagpur, has been granted privilege leave for six months. Mr. F. J. Plymen, A.C.G.I., will officiate as Principal during the absence on leave of Mr. Allan, or until further orders.

* * *

MR. C. P. MAYADAS, M.A., B.Sc., Assistant Director of Agriculture, Western Circle, Central Provinces, is appointed to officiate as Deputy Director of Agriculture of the same circle, *vice* Mr. F. J. Plymen.

* * *

MR. J. H. RITCHIE, M.A., B.Sc., Deputy Director of Agriculture, Northern Circle, Central Provinces, has been granted privilege leave for four months and 20 days. Mr. Nand Kishore, Extra Assistant Director of Agriculture, has been appointed to officiate until further orders.

MR. O. T. FAULKNER, B.A., Deputy Director of Agriculture, Lyallpur, has, on return from leave, resumed charge of his duties, relieving Malik Sultan Ali who remains attached to the Punjab Agricultural College.

* *

CAPTAIN K. J. S. DOWLAND, M.R.C.V.S., has been appointed to the Indian Civil Veterinary Department, and is posted to the Punjab as Professor of Sanitary Science, Punjab Veterinary College, Lahore.

* *

MR. E. SEWELL, M.R.C.V.S., has been appointed Post-Graduate Professor in the Punjab Veterinary College.

* *

MR. F. J. WARTH, M.Sc., Agricultural Chemist, Burma, was granted an extension of combined leave up to the 31st January, 1920.

* *

MR. W. HARRIS, M.R.C.V.S., Superintendent, Civil Veterinary Department, Assam, has been granted leave for one month and sixteen days in extension of the leave already granted to him.

WOODHOUSE-SOUTHERN MEMORIAL FUND.

Rs.

DONATIONS received up to the 30th November, 1919, and acknowledged in the *Agricultural Journal of India*, Vol. XV, Pt. I, January

1920	2,562
Sardar Darshan Singh (S)	20

TOTAL Rs. 2,582

Reviews

Botany for Agricultural Students.—By J. N. MARTIN. (New York : Wiley & Sons.)

Botany of Crop Plants.—By W. W. ROBBINS. (Philadelphia : P. Blakistons Son & Co.)

THE author of the first book states in his preface that his aim has been to present the fundamental principles of botany with emphasis on the practical application of these principles, chiefly to farm crops, forestry and horticulture. With this object, he deals in the first part of the book with the general structure and functions of plants, and in the second with particular types of plants, from thallophytes to gymnosperms, arranged according to their evolutionary relationships ; while the book ends with short chapters on the adaptation of plants to their environment, on evolution, variation and heredity, and the application of these to plant improvement.

To the agricultural student, the value of the book lies chiefly in the fact that economic plants are mainly used as illustrative material, and in this respect the book will be of use to students in this country, as the types described are generally more familiar than those usually presented in English text-books. For example, in the first part maize is fully described, and the illustrations showing the structure of the flower and other parts of this cereal are among the best in the book.

There are some notable omissions from the index. Though much attention is naturally given to wheat in the text, there is no mention of it in the index, either under its botanical or common names.

The second book is of a different nature to the first. While the first is a botanical text-book, the latter is more suitable to the student who has already undergone a course in general botany and wishes to take up the more detailed study, from a botanical and agricultural point of view, of particular crops. While it deals briefly in the introductory chapters with the main structure and functions of plants, chiefly with the view of rubbing up previously acquired knowledge, the main part of the book is devoted to chapters dealing with the botany, agriculture and economics of the chief crops familiar to the American student. In this way it deals with the chief cereal crops, fibre plants, oil-seeds, fruits, vegetables and condiments. The various groups of plants are preceded by a botanical description of the natural order to which they belong, and the chapters end with references to the most recent literature regarding the crop in question, which are fairly full and up-to-date. The book is well illustrated and is a useful addition to the list of text-books in English dealing with the botany of cultivated plants. [G. P. H.]

* * *

Drainage for Plantations : A Practical Handbook. By Claud Bald.
(Calcutta : Thacker, Spink & Co.)

“DRAINAGE is now looked upon as the foundation upon which all other agricultural improvements must be based.”

Everyone knows in a sort of casual way that drainage is necessary in certain soils and that no soil which is permanently saturated with water will produce good crops. A swamp, for instance, is unproductive. In arranging any system of drainage stagnant water must at all costs be eliminated. What is needed is a constant and fairly rapid flow of an even sheet of water through the soil which is followed by air, thus aerating the roots of plants in the soil as well as leaving the soil particles surrounded by water films from which the roots can obtain the water they need.

“It is a mistake to suppose that drainage carries away all the water out of the soil. It only carries off surplus water. The water which is held by capillary attraction and water films are retained

no matter how much the land is drained. If the land is not in a well drained condition the rain cannot enter the soil further than an inch or two, and consequently most of the rain must flow off the surface, carrying with it nearly all the fertilizing properties and also a great deal of surface soil and organic matter which has been weathered and prepared for plant food, all being lost and carried away in streams and rivers. On the other hand, wherever the soil is in a good state of drainage most of the rain passes through the surface soil leaving behind it the valuable fertility which it carried. This water also carries down with it the air which had been occupying the vacant spaces between the soil particles."

The benefits to be obtained from drainage are wider than even this, and it is an agricultural operation which does not always receive the attention which it should. One aspect of drainage which is often lost sight of is its effect upon diseases. Thus "Red Rust," a disease of tea due to the parasitic growth of an alga, is due to want of drainage to a very large extent. If the soil is drained and the root system of the tea deepened the disease disappears. More recently the Acting Chief Scientific Officer and the Entomologist of the Indian Tea Association have published a report on Tea Mosquito Blight, caused by an insect known as *Helopeltis*, in which they point out that an important factor of the disease is the question of soil water-logging, and they advise a good drainage system as one method of dealing with the pest.

The handy little book which has been quoted above will be found a most useful addition to the library of every agriculturalist, setting forth as it does the principles of drainage, and the methods which can be adopted to attain it, in a condensed form and simple language. The author, who is well known for his excellent book on "Indian Tea," has been most successful in his object of giving a summary of points necessary for planters who require scientific data on this subject in a condensed and handy form. [R. D. A.]

NEW BOOKS

ON AGRICULTURE AND ALLIED SUBJECTS

1. The Ecological Relations of Roots, by Prof. J. E. Weaver. Pp. vii+128+30. (Washington: Carnegie Institution.)
2. Agriculture and Farming Business, by O. H. Benson and George Herbert Betts. Pp. xvii+778. (London: Kegan Paul, Trench, Trubner & Co., Ltd.) Price, 10s. 6d. net.
3. Introduction to Physical Chemistry, by Prof. James Walker. Eighth edition. Pp. xiii+433. (London: Macmillan & Co., Ltd.) Price, 16s. net.
4. The Chemical Chemistry of the Proteins, by T. Brailsford Robertson. (London: Longman, Green & Co.) Price, 25s. net.
5. A Course of Practical Chemistry for Agricultural Students, by H. A. D. Neville and L. F. Newman. Vol. II, Pt. I. Pp. 122. (Cambridge: At the University Press.) Price, 5s. net.
6. Commercial Oils: Vegetable and Animal, with a special reference to Oriental Oils, by I. F. Laucks. Pp. viii+138. (London: Chapman & Hall.) Price, 6s. net.
7. Applied Botany, by G. S. M. Ellis. Pp. viii+248. (London: Hodder & Stoughton.) Price, 4s. 6d. net.
8. Elementary Biology, by B. C. Gruenberg. Pp. x+528. (Boston & London: Grinn & Co.) Price, 7s. net.
9. Science and Fruit-growing, being an account of the results obtained at the Woburn Experimental Fruit Farm since its foundation in 1894, by the Duke of Bedford, K.G., F.R.S., and Spencer Pickering, M.A., F.R.S. (London: Macmillan & Co., Ltd.) Price, 12s. 6d. net.
10. Experiments with Plants, by J. B. Philips. Pp. 207. (Oxford: At the Clarendon Press.) Price, 3s. net.

11. Applied Chemistry, by Dr. C. K. Tuikler and H. Masters. Vol. I. Pp. xii+292. (London: Crosby Lockwood & Son.) Price, 12s. 6d. net.
12. Wonders of Insect Life, by J. H. Crabtree. Pp. vii+211+32 plates. (London: G. Routledge & Sons.) Price, 6s. net.
13. Popular Chemical Dictionary, by C. T. Kingzett. Pp. vi+368. (London: Baillière, Tindall & Cox.) Price, 12s. 6d. net.
14. A Manual of the Electro-Chemical Treatment of Seeds, by C. Mercier. Pp. 134. (London: University of London Press.) Price, 3s. 6d. net.
15. My Five-acre Holding, by M. Few. Pp. 164. (London: Hodder & Stoughton.) Price, 3s. 6d. net.
16. Mendelism, by R. C. Punnett. Fifth edition. Pp. 215. (London: Macmillan & Co., Ltd.) Price, 7s. 6d. net.
17. Commercial Poultry Farming, by T. W. Toovey. Pp. 140. (London: Crosby Lockwood & Son.) Price, 7s. 6d. net.

THE following publications have been issued by the Imperial Department of Agriculture in India since our last issue:—

Memoir.

1. Studies in the Pollination of Indian Crops, I, by A. Howard, C.I.E., M.A., Gabrielle L. C. Howard, M.A., and Abdur Rahman Khan. (Botanical Series, Vol. X, No. 5.) Price, R. 1-4 or 2s. 6d.

Reports.

1. Report on the Progress of Agriculture in India for the year 1918-19. Price, R. 1-4 or 2s.
2. Proceedings of the Board of Agriculture in India, held at Pusa on the 1st December, 1919, and following days (with Appendices). Price, As. 12 or 1s. 3d.

PUBLICATIONS OF THE IMPERIAL DEPARTMENT OF AGRICULTURE IN INDIA

TO BE HAD FROM

THE OFFICE OF THE AGRICULTURAL ADVISER TO THE GOVERNMENT OF INDIA, PUSA, BIHAR,
and from the following Agents :—

- | | |
|--|---|
| (1) THACKER, SPINK & CO., CALCUTTA. | (7) THACKER & CO., LTD., BOMBAY. |
| (2) W. NEWMAN & CO., CALCUTTA. | (8) SUNDER PANDURANG, BOMBAY. |
| (3) RAI M. C. SARKAR BAHADUR & SONS, CALCUTTA. | (9) RAI SAHIB M. GULAB SINGH & SONS, LAHORE. |
| (4) HIGGINBOTHAMS, LTD., MADRAS. | (10) MANAGER, EDUCATIONAL BOOK DEPOT, NAGPUR. |
| (5) THOMPSON & CO., MADRAS. | |
| (6) D. B. TARAPOREVALA, SONS & CO., BOMBAY. | |

A complete list of the publications of the Imperial Department of Agriculture in India can be obtained on application from the Agricultural Adviser to the Government of India, Pusa, Bihar, or from any of the above-mentioned Agents.

These publications are :—

1. *The Agricultural Journal of India*. A Journal dealing with subjects connected with agricultural economics, field and garden crops, economic plants and fruits, soils, manures, methods of cultivation, irrigation, climatic conditions, insect pests, fungus diseases, co-operative credit, agricultural cattle, farm implements, and other agricultural matters in India. Illustrations, including coloured plates, form a prominent feature of the Journal. It is edited by the Agricultural Adviser to the Government of India, and is issued once every two months or six times a year. *Annual Subscription*, Rs. 6 or 9s. 6d., including postage. *Single copy*, R. 1-8 or 2s.
2. Scientific Reports of the Agricultural Research Institute, Pusa (including the Report of the Imperial Cotton Specialist).
3. Annual Report on the Progress of Agriculture in India.
4. Proceedings of the Board of Agriculture in India.
5. Proceedings of Sectional Meetings of the Board of Agriculture.
6. Memoirs of the Imperial Department of Agriculture in India :
 - (a) Botanical Series.
 - (b) Chemical Series.
 - (c) Entomological Series.
 - (d) Bacteriological Series.
 - (e) Veterinary Series.
7. Bulletins issued by the Agricultural Research Institute, Pusa.
8. Books.

The following are the publications of the last two years :—

Scientific Reports of the Agricultural Research Institute and College, Pusa (including the Report of the Imperial Cotton Specialist), for the year 1917-18. Price, R. 1-4 or 2s.

AGRICULTURAL PUBLICATIONS.—(Concl'd.)

- Scientific Reports of the Agricultural Research Institute, Pusa (including the Report of the Imperial Cotton Specialist), for the year 1918-19. Price, R. 1-4 or 2s.
- Report on the Progress of Agriculture in India for the year 1917-18. Price, R. 1-8 or 2s. 3d.
- Report on the Progress of Agriculture in India for the year 1918-19. Price, R. 1-4 or 2s.
- Proceedings of the Board of Agriculture in India, held at Pusa on the 1st December, 1919, and following days (with Appendices). Price, As. 12 or 1s. 3d.
- Proceedings of the Second Meeting of Mycological Workers in India, held at Pusa on the 20th February, 1919, and following days. Price, As. 11 or 1s.
- Proceedings of the First Meeting of Agricultural Chemists and Bacteriologists, held at Pusa on 24th February, 1919, and the following days. Price, R. 1 or 1s. 6d.
- Proceedings of the First Meeting of Veterinary Officers in India, held at Lahore on the 24th March, 1919, and following days (with Appendices). Price, As. 8 or 9d.

MEMOIRS OF THE DEPARTMENT OF AGRICULTURE IN INDIA

BOTANICAL SERIES

- Vol. IX, No. IV. Studies in Indian Sugarcane, No. 3. The Classification of Indian Canes with special reference to the Saretha and Sunnabile Groups, by C. A. BARBER, sc.D. Price, Rs. 2-4 or 3s.
- Vol. IX, No. V. *Phytophthora Meadii* n. sp. on *Hevea brasiliensis*, by W. MURAE, M.A., B.Sc., F.L.S. Price, R. 1-4 or 2s.
- Vol. X, No. I. The Rice Worm (*Tylenchus angustus*) and its Control, by E. J. BUTLER, M.B., F.L.S. Price, R. 1-4 or 2s.
- Vol. X, No. II. Studies in Indian Sugarcane, No. 4. Tillering or Underground Branching, by C. A. BARBER, C.I.E., sc.D., F.L.S. Price, Rs. 4-4 or 7s.
- Vol. X, No. III. Studies in Indian Sugarcane, No. 5. On testing the suitability of sugarcane varieties for different localities, by a system of measurements. Periodicity in the growth of the sugarcane, by C. A. BARBER, C.I.E., sc.D., F.L.S. Price, R. 1-12 or 3s.
- Vol. X, No. IV. A *Pythium* Disease of Ginger, Tobacco and Papaya, by L. S. Subramaniam. Price, R. 1-8 or 2s. 6d.
- Vol. X, No. V. Studies in the Pollination of Indian Crops, 1, by A. HOWARD, GABRIELLE L. C. HOWARD, and ABDUR RAHMAN KHAN. Price, R. 1-4 or 2s. 6d.

CHEMICAL SERIES

- Vol. V, No. II. "Heart Damage" in Baled Jute, by R. S. FINLOW, B.Sc., F.I.C., F.C.S. Price, R. 1 or 1s. 6d.
- Vol. V, No. III. Experiments on the Improvement of the Date Palm Sugar Industry in Bengal, by HAROLD E. ANNETT, B.Sc., F.I.C.; GOSTA BEHARI PAL, M.Sc.; and INDU BHUSHAN CHATTERJEE, L.Ag. Price, R. 1 or 1s. 6d.
- Vol. V, No. IV. Cholam (*A. Sorghum*) as a Substitute for Barley in Malting Operations, by B. VISWANATH, T. LAKSHMANA ROW, B.A., and P. A. RAGHUNATHASWAMI AYYANGAR, Dip. ag. Price, As. 12 or 1s.
- Vol. V, No. V. The Phosphate Requirements of some Lower Burma Paddy Soils, by F. J. WARTH, M.Sc., B.Sc., and Maung Po Shin. Price, R. 1-12 or 3s. 3d.
- Vol. V, No. VI. Absorption of Lime by Soils, by F. J. WARTH, M.Sc., B.Sc., and MAUNG PO SAW. Price, R. 1-2 or 2s.

ENTOMOLOGICAL SERIES

- Vol. V, No. V. The Rice Leaf-hoppers (*Nephotettix bipunctatus*, Fabr. and *Nephotettix apicalis*, Motsch.), by C. S. MISRA, B.A. (In the press.)
- Vol. V, No. VI. *Lantana* Insects in India. Being the Report of an Inquiry into the Efficiency of Indigenous Insect Pests as a Check on the Spread of *Lantana* in India, by Y. RAMACHANDRA RAO, M.A., F.E.S. (In the press.)

BACTERIOLOGICAL SÉRIÉS

- Vol. I, No. VII. A Bacterial Disease of Wheat in the Punjab, by C. M. HUTCHINSON, B.A.
Price, As. 12 or 1s.

VETERINARY SERIES

- Vol. II, No. VIII. *Kumri*: Combined Diffuse Sclerosis and Central Poliomyelitis of Horses,
by G. H. K. MACALISTER, M.A., M.D., D.P.H. Price, R. 1-8 or 2s. 6d.
- Vol. III, No. I. The Vitality of the Rinderpest Virus outside the Animal Body under
Natural Conditions, by A. W. SHILSTON, M.R.C.V.S. Price, As. 12 or 1s.

BULLETINS ISSUED BY THE AGRICULTURAL RESEARCH INSTITUTE, PUSA

- No. 77. Some Camel-feeding Experiments, by H. E. CROSS, M.R.C.V.S., D.V.H., A.Sc. Price
As. 2 or 3d.
- No. 78. Smuts of Jowar (*Sorghum*) in the Bombay Presidency, by G. S. KULKARNI, L.A.G.
Price, As. 4 or 5d.
- No. 79. Prussic Acid in Burma Beans, by F. J. WARTH, B.Sc., M.Sc.; and KO KO GYL.
Price, As. 2 or 3d.
- No. 80. Are Camels Susceptible to Black Quarter, Hamorrhagic Septicæmia and Rinderpest
by H. E. CROSS, M.R.C.V.S., D.V.H., A.Sc. Price, As. 4 or 5d.
- No. 81. The Value of Phosphatic Manures in India and the Possibility of their Manufacture
on a Larger Scale. Being evidence submitted to the Committee appointed
to discuss this question (Subject IX) at the Meeting of the Board of Agriculture,
Poona, 1917. Edited, with an Introduction, by W. A. DAVIS, B.Sc., A.C.G.I.
Price, As. 4 or 5d.
- No. 82. The Improvement of the Indigenous Methods of *Gur* and Sugar making in the United
Provinces, by WILLIAM HULME and R. P. SANGHI. Price, As. 8 or 9d.
- No. 83. Progress of the Sugarcane Industry in India during the Years 1916 and 1917. Being
Notes submitted to the Meeting of the Board of Agriculture in India, Poona, 1917.
Edited, with an Introduction, by C. A. BARBER, C.I.E., Sc.D., F.L.S. Price, As. 5
or 6d.
- No. 84. The Best Means of Rapidly Increasing the Outturns of Food Crops by Methods
within the Power of the Agricultural Department. Being Notes submitted to the
Meeting of the Board of Agriculture in India, Poona, 1917. Edited, with an
Introduction, by J. MACKENNA, C.I.E., I.C.S. Price, As. 4 or 5d.
- No. 85. Soil Drainage, by R. G. ALLAN, M.A. Price, As. 4 or 5d.
- No. 86. A New Nematode causing Parasitic Gastritis in Calves, by A. L. SHEATHER, B.Sc.,
M.R.C.V.S. Price, As. 4 or 5d.
- No. 87. A Contribution to our Knowledge of South Indian Coccidiæ, by T. V. RAMAKRISHNA
AYYAR, B.A., F.E.S., F.Z.S. Price, As. 14 or 1s. 6d.
- No. 88. Cawnpore-American Cotton: An Account of Experiments in its Improvement by
Pure Line Selection and of Field Trials, 1913-1917, by B. C. BURT, B.Sc., and
NIZAMUDDIN HAIDER. Price, As. 10 or 1s.
- No. 89. Second Hundred Notes on Indian Insects. Price, R. 1-4 or 2s.
- No. 90. A Malarial Parasite in the Blood of a Buffalo, by A. L. SHEATHER, B.Sc., M.R.C.V.S.
Price, As. 6 or 7d.
- No. 91. Notes on Practical Salt Land Reclamation, by G. S. HENDERSON, N.D.A., N.D.D.
(*In the press.*)
- No. 92. *Syngamus laryngens* in Cattle and Buffaloes in India, by A. LESLIE SHEATHER, B.Sc.,
M.R.C.V.S., and A. W. SHILSTON, M.R.C.V.S. (*In the press.*)
- No. 93. The Orange: The Trial of Stocks at Peshawar, by W. ROBERTSON BROWN. (*In the
press.*)

BULLETINS ISSUED BY THE AGRICULTURAL RESEARCH INSTITUTE, PUSA—(Concl'd.)

- No. 94. A Preliminary Note on the Behaviour in North India of the first batch of Sugarcane Seedlings distributed from the Sugarcane-breeding Station, Coimbatore, by T. S. VENKATARAMAN, B.A. (*In the press.*)

INDIGO PUBLICATIONS

- No. 1. A Study of the Indigo Soils of Bihar. The Urgent Necessity for Immediate Phosphate Manuring if Crops are to be Maintained, by W. A. DAVIS, B.Sc., A.C.G.I. Price, R. 1-4 or 2s.
- No. 2. Present Position and Future Prospects of the Natural Indigo Industry, by W. A. DAVIS, B.Sc., A.C.G.I. Price, As. 10 or 1s.
- No. 3. The Loss of Indigo caused by Bad Settling and the means of obviating this. The use of Dhak Gum—its Effect on Yield and Quality, by W. A. DAVIS, B.Sc., A.C.G.I. Price, As. 4 or 5d.
- No. 4. The Future Prospects of the Natural Indigo Industry: The Effect of Superphosphate Manuring on the Yield and Quality of the Indigo Plant, by W. A. DAVIS, B.Sc., A.C.G.I. Price, As. 4 or 5d.
- No. 5. An Improved Method of preparing Indican from Indigo-yielding Plants, by BHAILAL M. AMIN, B.A. Price, As. 2 or 3d.
- No. 6. The Effect of Manuring with Superphosphate and Sannai on the Yield of Crops on Indigo Planters' Estates in Bihar—especially of Rabi Crops in the Season 1918-1919, by W. A. DAVIS, B.Sc., A.C.G.I. (*In the press.*)

BOOKS

- "Indian Insect Pests," by H. MAXWELL-LEFROY, M.A., F.E.S., F.Z.S. Price, R. 1-8 or 2s. (*Out of print.*)
- "Indian Insect Life," by H. MAXWELL-LEFROY, M.A., F.E.S., F.Z.S.; and F. M. HOWLETT, B.A. 786 pp. Price, Rs. 20 or 30s. (*Out of print.*)
- "Wheat in India," by ALBERT HOWARD, M.A., A.R.C.S., F.L.S.; and GABRIELLE L. C. HOWARD, M.A. 286 pp. Price, Rs. 5 or 7s. 6d.
- "A Description of the Imperial Bacteriological Laboratory, Muktesar: Its Work and Products," by Major J. D. E. HOLMES, M.A., D.Sc., M.R.C.V.S. Price, As. 8 or 9d.
- "Agriculture in India," by JAMES MACKENNA, M.A., I.C.S. Price, As. 4 or 5d.
- "Some Diseases of Cattle in India. A Handbook for Stock-owners." Price, As. 8 or 9d.
- "The Importance of Bacterial Action in Indigo Manufacture," by C. M. HUTCHINSON, B.A. Price, As. 2 or 3d.
- "Report of the Proceedings of the Second Entomological Meeting, held at Pusa on the 5th—12th February 1917." Price, Rs. 3.

Report of the Indian Cotton Committee. Vol. I, Report; Vol. II, Maps and Plans. Price, R. 1 per volume. (Superintendent: Government Printing, India, Calcutta.)

VOL. XV, PART III

May, 1920

THE AGRICULTURAL JOURNAL OF INDIA



EDITED BY

The Agricultural Adviser to the Government of India

PUBLISHED FOR

THE IMPERIAL DEPARTMENT OF AGRICULTURE IN INDIA

BY

THACKER, SPINK & CO., CALCUTTA

W. THACKER & CO., 2, CREED LANE, LONDON

Price R. 1-8 or Two Shillings

Agents for the Sale of Government Publications

IN EUROPE

- Constable & Co., 10, Orange Street, Leicester Square, London, W.C.
Kegan Paul, Trench Trübner & Co., 68-74, Carter Lane, E.C., and 25, Museum Street, London, W.C.
Bernard Quaritch, 11, Grafton Street, New Bond Street, London, W.
P. S. King & Sons, 2 & 4, Great Smith Street, Westminster, London, S.W.
H. S. King & Co., 65, Cornhill, E.C., and 9, Pall Mall, London, W.
Grindlay & Co., 54, Parliament Street, London, S.W.
Luzac & Co., 46, Great Russell Street, London, W.C.
W. Thacker & Co., 2, Creed Lane, London, E.C.
T. Fisher Unwin, Limited, 1, Adelphi Terrace, London, W.C.
B. H. Blackwell, 50 & 51, Broad Street, Oxford.
Deighton, Bell & Co., Ltd., Cambridge.
Oliver & Boyd, Tweeddale Court, Edinburgh.
E. Ponsonby, Ltd., 116, Grafton Street, Dublin.
Ernest Leroux, 28, Rue Bonaparte, Paris.
Martinus Nijhoff, The Hague, Holland.

IN INDIA AND CEYLON

- Thacker, Spink & Co., Calcutta and Simla.
W. Newman & Co., Calcutta.
R. Cambay & Co., Calcutta.
S. K. Lahiri & Co., Calcutta.
B. Bannerjee & Co., Calcutta.
The Indian School Supply Depot, 309, Bow Bazar Street, Calcutta, and 226, Nawabpur, Dacca.
Butterworth & Co. (India), Ltd., Calcutta.
Rai M. C. Sarkar Bahadur & Sons, 75-1-1, Harrison Road, Calcutta.
The Weldon Library, 18-5, Chowringhee Road, Calcutta.
Standard Literature Co., Ltd., Calcutta.
Lal Chand & Sons, Calcutta.
Higginbothams, Ltd., Madras.
V. Kaliyanarama Iyer & Co., Madras.
G. A. Natesan & Co., Madras.
S. Murthy & Co., Madras.
Thompson & Co., Madras.
Temple & Co., Madras.
P. R. Rama Iyer & Co., Madras.
E. M. Gopalakrishna Kone, Madura.
Thacker & Co., Ltd., Bombay.
A. J. Combridge & Co., Bombay.
D. B. Taraporewala, Sons & Co., Bombay.
Mrs. Radhabai Atmaram Sagoon, Bombay.
Sunder Pandurang, Bombay.
Gopal Narayan & Co., Bombay.
Ramchandra Govind & Son, Kalbadevi, Bombay.
A. H. Wheeler & Co., Allahabad, Calcutta, and Bombay.
N. B. Mathur, Superintendent, Nazir Kanun-i-Hind Press, Allahabad.
Rai Sahib M. Gulab Singh & Sons, Mufid-i-Am Press, Lahore.
A. Chand & Co., Lahore, Punjab.
Ram Krishna & Sons, Lahore.
Superintendent, American Baptist Mission Press, Rangoon.
Manager, the "Hitavada," Nagpur.
S. C. Talukdar, Proprietor, Students & Co., Cooch Behar.
A. M. & J. Ferguson, Colombo, Ceylon.
Manager, Educational Book Depôts, Nagpur and Jubbulpore.*
Manager of the Imperial Book Depot, 63, Chandney Chauk Street, Delhi.*
Manager, "The Agra Medical Hall and Co-operative Association, Ltd." (Successors to A. John & Co., Agra.)*
Superintendent, Basel Mission Book and Tract Depository, Mangalore.*
P. Varadachary & Co., Madras.*
H. Liddell, Printer, etc., 7, South Road, Allahabad.*
D. C. Anand & Sons, Peshawar.*
Ram Dayal Agarwala, 184, Katra, Allahabad.*
Manager, Newal Kishore Press, Lucknow.*

* Agents for the sale of Legislative Department Publications only.

CONTENTS

(VOL. XV. PART III.)

ORIGINAL ARTICLES

PAGE

SOME COMMON INDIAN BIRDS. No. 3 --THE SPOTTED OWLET (<i>Athene brama</i>)	.. <i>T. Bainbrigg e Fletcher, R.N., F.L.S., F.E.S., F.Z.S.; and C. M. Inglis, M.B.O.U., F.Z.S.</i>	.. 235
THE POSSIBILITIES OF AGRICULTURE IN INDIA WITHIN THE NEXT TWENTY YEARS	.. <i>D. Clouston, C.I.E., M.A., B.Sc.</i>	239
SOME ASPECTS OF PLANT GENETICS	.. <i>W. Burns, D.Sc.</i>	250
SOME ASPECTS OF COTTON IMPROVEMENT IN INDIA	.. <i>H. C. Sampson, B.Sc.</i>	277
THE "TAMBERA" DISEASE OF POTATO	.. <i>Harold H. Mann, D.Sc. ; S. D. Nag- purkar, B.Ag. ; and G. S. Kulkarni, L.Ag.</i>	282
THE BIOLOGICAL ASPECTS OF WHEAT CULTIVA- TION ON EMBANKED SOILS	.. <i>F. J. Plymen, A.C.G.I. ; and D. V. Bal, L.Ag.</i>	289

SELECTED ARTICLES

THE FUTURE OF WHEAT PRODUCTION WITH SPECIAL REFERENCE TO THE EMPIRE	301
THE GROWTH OF THE SUGARCANE, II	334
REPORT OF THE LINCOLN TRIALS	341

NOTES		PAGE
MOTOR TRACTOR TRIALS AT NAGPUR		348
CATTLE SALE AND DEMONSTRATION AT PUSA		349
THE USE OF SOME SALT WATER PLANTS AS FODDER		350
EXPERIMENTS WITH PEANUTS IN MESOPOTAMIA		351
PERSONAL NOTES, APPOINTMENTS AND TRANSFERS, MEETINGS AND CONFERENCES, ETC.		353
REVIEWS		
LES AMENDAS ET L'HUILE DE PALME		358
BLOOD-SUCKING INSECTS OF FORMOSA		361
ANNUAL REPORT OF THE DISTRICT AGRICULTURAL ASSOCIATION OF BIRBHUM AND ITS BRANCH ASSOCIATIONS FOR 1919-20		361
NEW BOOKS ON AGRICULTURE AND ALLIED SUBJECTS		363
LIST OF AGRICULTURAL PUBLICATIONS IN INDIA FROM 1ST AUGUST, 1919, TO 31ST JANUARY, 1920	After p.	364

LIST OF ILLUSTRATIONS

The Spotted Owlet (<i>Athene brama</i>)	Frontispiece
	Facing page
Plate XV. Typical attacks of <i>Tambora</i> disease	283
„ XVI. Plants inoculated with <i>Tambora</i> mite and control plant without inoculation	286
„ XVII. Plots of sugarcane showing the effect of a cyclonic storm on an unwrapped field	338
„ XVIII. Plots of wrapped sugarcane	339

*The following Original Articles will appear in our next issue
(July 1920).*

- PRINCIPAL FODDERS IN THE CENTRAL PROVINCES
AND BERAR INCLUDING THE SMALL BAMBOO
(*Dendrocalamus strictus*) *D. Clouston, C.I.E., M.A.,
B.Sc.; and F. J. Plymen,
A.C.G.I.*
- VARIATIONS IN SOME CHARACTERISTICS OF THE
FAT OF BUFFALO AND COW MILK WITH
CHANGES IN SEASON AND FEEDING .. *F. J. Plymen, A.C.G.I.; and
A. R. P. Aiyer.*
- HABIT IN SUGARCANE *U. Vittal Rao.*
- COMPARISON OF SALT LANDS IN THE DECCAN
AND IN SIND *V. A. Tamhane, M.Sc.*
- STUDIES IN BIOLOGICAL DECOMPOSITION OF COW-
DUNG AND URINE IN SOIL *N. V. Joshi, M.Sc., L.Ag.*
- SOME FACTS AND FIGURES REGARDING BANANA
CULTIVATION *W. Burns, D.Sc.; and P. G.
Dani.*



THE SPOTTED OWLET (*ATHENE BRAMA*).

Original Articles

SOME COMMON INDIAN BIRDS.

No. 3. THE SPOTTED OWLET (*ATHENE BRAMA*).

BY

T. BAINBRIGGE FLETCHER, R.N., F.L.S., F.E.S., F.Z.S.,
Imperial Entomologist ;

AND

C. M. INGLIS, M.B.O.U., F.Z.S.

OF the two score or so of species of owls which are found within Indian limits, the Spotted Owlet (*Athene brama*) is probably at once the commonest and most familiar, as it occurs abundantly throughout the Plains of India and Burma (although not found in Ceylon) and is in evidence during the early evening often before sunset and long before dusk, when most other owls have not yet ventured out. It is, moreover, quite a domestic owl, keeping especially to trees in cultivated tracts such as gardens around houses, and it is commonly found roosting and breeding in the roofs of houses where these afford the necessary shelter. It is fond of perching on the branch of a tree or on a pole or fence or telegraph-wire ; indeed, as Hume remarks, it is one of the birds that seem to think that telegraph-wires were erected for their sole and especial benefit. It is a decidedly noisy bird, making itself most evident to the ear in the evening or early morning, but frequently heard at intervals during the night, when a regular volley of

chuckles and squeaks is poured forth by one or more of these little owlets ; but the noise is not sustained for any length of time.

In the daytime, like other owls, the Spotted Owlet hides away in some dark corner, such as a hole in a tree or wall or in a house-roof or even in a bungalow verandah if no better situation offers, emerging towards sunset to hunt for prey. As Cunningham remarks, it is most diverting to watch them emerging ; one after another, before fairly coming out, putting forth its queer little round head and staring eyes through the opening of the cavern. After they have emerged they usually sit very quietly for a time as though only half awake, and are either perfectly silent or occasionally utter a low-toned " chirrk." Then, all of a sudden, they begin to chuckle and finally break out into a perfect torrent of hoarse chattering ; and finally, after having indulged in such exercises for some minutes, they spread their short, rounded wings and sail off to their night's hunting.

However, it does not seem to mind the full blaze and heat of the sun, as we have seen it in the early afternoon on a hot April day sunning itself with outspread wings on the bare gravel in front of the bungalow. A pair which have for years inhabited the bungalow of one of us (C. M. I.) may often be seen during the daytime either perched on some *sambhar's* antlers on the verandah wall or else flying with undulating flight to a tree in the garden, usually to a tamarind tree, and, after staying there a short time, returning to their hole. We have also seen them on a drizzly day seated on a perch outside, enjoying a shower bath.

It is one of the birds that hawk termites (white ants, so called) along with Rollers, etc. Mr. Stuart Baker writes that they are great bat hunters, not catching them on the wing but hauling them out of their holes ; but apparently all these owls do not wage war against bats and this habit is perhaps local or confined to a few individuals.

It lives chiefly on insects and to a less extent on mice, shrews and lizards, its insect prey consisting mostly of beetles and crickets. In the case of eight birds examined at Pusa by the late C. W. Mason, of 69 insects taken, one was of a beneficial species, twenty-six were

neutral and forty-two were injurious. Hume mentions a case, reported by Colonel Butler, in which a pair of Spotted Owlets had apparently attacked a nesting Paroquet (*P. torquatus*), killed it on the nest and taken possession of this for themselves. As the Paroquet is a perfect pest to the agriculturist, we can only wish that the Spotted Owlet would act regularly in this way. At Pusa this little owl seems to live largely on large crickets (*Brachytrypes* and *Gryllotalpa*) and on dung-beetles. There is no-doubt that it is a most useful bird in all districts where large crickets occur so commonly as to do damage. As these crickets are nocturnal, retreating into their subterranean burrows during the daytime and only emerging to feed under cover of night, their most effective natural enemies are those, such as the Spotted Owlet, which are also nocturnal and which can swoop down and destroy them whilst they are feeding above-ground. One commonly sees this little owl swoop down from its perch and catch some prey on the ground, returning to its perch to devour it, usually to the accompaniment of a burst of chattering which is presumably its form of thank-offering for a good supper.

Our Plate gives a good idea of this little owl and the left-hand figure shows the terrifying attitude, assumed, after first sitting up very erect, by suddenly crouching down and frowning and glaring in a terrible way, to frighten any observer or intruder.

The Spotted Owlet breeds from February to April, the period being slightly earlier in the South and later in Northern India, but the great majority of birds lay in March, laying usually three, four or five white (pink when fresh) eggs in a hole in a tree or building, the nest being scantily lined with a few dry leaves, grass, decayed wood, or feathers. We have taken three clutches of three eggs each from one nest but even then the birds would not desert their nesting site. Incubation evidently starts as soon as the bird lays as we have taken at the same time from one nest one young, two highly incubated and one perfectly fresh egg. The fluffy young, when fledged, are drab-and-white with yellow eyes just like their parents and, also like their parents, are exceedingly noisy, each member of the family, as Dewar puts it, talking gibberish at the

top of its voice, sixteen to the dozen, and as all will persist in speaking at once, the result is a nocturnal chorus that will bear comparison with the efforts of the cats which enliven the Londoner's back yard.

Jerdon, quoting Sykes, writes that "the Mahrattas have a superstition regarding this species, and a class of people called *Pingleh* live on the credibility of the people by pretending to consult it and predict events." Jerdon also says that this Owlet is used by some *shikaris* to catch small birds. It is pegged out near a low bush, the branches of which have been smeared with bird-lime, so that any small birds that come to mob it settle on the bush and are caught on the limed twigs. It is, however, noticeable that this owl does not seem to be molested by birds, as other larger owls are, probably because it is more at home in daylight and so does not attract notice by the blundering flight assumed by other owls when they venture out by day. Its flight is indeed far from a blundering one and, in a recent issue of the Bombay Natural History Society's Journal, Mr. G. O. Allen has called attention to its occasional habit of hovering; this we have also noticed at times and it is probably assumed when watching some small prey which has emerged from its burrow.

THE POSSIBILITIES OF AGRICULTURE IN INDIA WITHIN THE NEXT TWENTY YEARS.*

BY

D. CLOUSTON, C.I.E., M.A., B.Sc.,

Director of Agriculture, Central Provinces and Be ar.

I HAVE to extend to you a hearty welcome to this meeting of the Agriculture and Applied Botany Section of the Indian Science Congress. I very much appreciate the honour of being asked to preside over this section. The subject on which I am to address you is one which will, I trust, be of interest to many here ; for most of us are beginning to realize how potent a factor science is in the development of India's greatest industry—agriculture.

It has been said that in the career of a department, as in the life of a man, there are stages from which it is appropriate to take a glance backward and to contemplate the outlook of the future. Prophecy being the rôle of science, I am to play the part of a prophet on this occasion in so far as I shall, in the light of the progress already made in developing agriculture in India, try to give some indication of the rate of advancement to be looked for in future.

At the present stage of advancement a study of the history of agricultural development in England, where many of the difficulties were experienced which we are up against in India to-day, may prove helpful. Till the latter part of the eighteenth century the agricultural unit in Great Britain was the village with its scattered holdings, common grazing grounds, half-starved cattle and poor crops resulting from bad cultivation, which are so characteristic of many parts of India at the present day. Many improvements

* Presidential Address to the Agricultural Section of the Seventh Indian Science Congress, Nagpur, 1920.

had been introduced before that time; the more enterprising farmers had learnt, for example, how to grow turnips, clover, artificial grasses and other fodder crops, how to avoid the need of fallows by adopting suitable rotations, and how to grow crops in line by using seed drills for sowing and hoes for interculture. These improvements were, however, not generally adopted for many years because of the difficulty of protecting such fodder crops in villages which had not been enclosed.

The Napoleonic wars and the rapid development of our manufacturing industries in the latter years of the eighteenth century and the early part of the nineteenth gave a great impetus to English agriculture by forcing up prices of farm produce. High prices, coupled with a rise in the cost of labour, encouraged the use of labour-saving appliances and the production of larger acreage outturns. The open field system of scattered holdings with its bad cultivation which resulted therefrom began to give way slowly before economic pressure and the more intensive methods of farming which began to be adopted by the leading "gentlemen" farmers of the land. Consolidated holdings were fenced and the cultivation of turnips, clover and other new crops, which were to revolutionize farming, were taken up on a larger scale than ever before. Progress, however, was not so rapid as it might have been, as most of our English farmers of this period, like their fathers before them, stuck to their empirical methods based on old use and wont; for there was as yet no science of agriculture which could be applied to the solution of its manifold problems. Such advancement as was made in those days can be directly attributed to the interest taken in improved husbandry by men like Jethro Tull, Bakewell, Lord Townsend and Arthur Young who, though not themselves scientists in our sense of the term, possessed the scientific habit of mind which they brought to bear on the agricultural problems of the day.

Science began to be applied systematically to the development of the agricultural resources of England about the middle of the nineteenth century, and with very beneficial results. By better breeding and better feeding, her breeds of cattle, sheep and horses were improved out of all resemblance to their progenitors; Great Britain

became the world's stud farm. Labour-saving machinery and better methods of cultivation were rapidly introduced and improved strains of seed raised. More attention was given to the improvement of the soil by drainage and manuring, to the protection of crops from cattle, and to the better housing of live stock. As a result of the improvements effected, the acreage yield of the staple crops and the average weight of cattle and sheep were more than doubled. These and other improvements introduced in the latter half of the last century have added largely to the material welfare of the English farmer. Development would have been much more rapid however, had her statesmen fully realized the enormous possibilities there were of agriculture being benefited by experiment and research. For the splendid progress that was made we are largely indebted to the great work done by scientists like Lawes and Gilbert ; to enterprising seedsmen like Garton and Sutton ; to the ingenuity of manufacturing firms which vied with each other in designing machinery suitable for the farm ; and to the fine example of the larger farmers who were in a position to utilize to the full the modern developments of organization and scientific knowledge.

As a result of the exigencies of the great war now happily ended, scientific enquiry in all branches of industry has, since 1914, been stimulated to an extraordinary extent. Never before has the value of agricultural science had such recognition. Statesmen and the public generally have come to realize the paramount importance of providing for the endowment of work connected with the development of agriculture on a scale commensurate with its great importance, because they now see, as they never did before, that "the countries which have made the greatest progress and which obtain from their soil the highest returns are those which have increased their research institutions." Denmark was obliged to do so after her defeat by Germany in 1863, and has, as the result, been able to increase the acreage outturns of her staple crops by 24 per cent. in the short space of a little over 50 years. Germany, foreseeing the possibility of being blockaded by the British fleet in the event of a war with our country, had, for 40 years previous to the outbreak of war, been studiously organizing her institutions for experiment and

research in agriculture, with the result that, when war broke out, her resisting power came as a most unwelcome surprise to the allies, who had hoped to sap her strength by starvation.

Let us now consider the position of agriculture in India and the possibility of our benefiting from the experience gained in other countries. The economic conditions which obtain at the present time in India resemble in many respects those which stimulated agriculture in England in the early part of the nineteenth century. A great war has again forced up the prices of farm produce to an abnormal figure. The industries of this country are being developed with phenomenal rapidity. The cost of farm labour is rising and will continue to rise, for the new industries will continue to draw workers from rural areas. If they are to take full advantage of the golden opportunities which are now offered them, landholders in this country will have to use labour-saving machinery on a much larger scale than formerly, and they will be obliged to adopt more intensive methods of cultivation all round, involving manuring and irrigation on a large scale. So long as prices remain at their present high level intensive cultivation will pay handsomely. Manures, for instance, which were applied at a loss five years ago, can now be applied at a handsome profit. The present favourable position of the market for agricultural produce marks, in short, the beginning of an era of prosperity for the cultivator if he will but take advantage of his opportunities. He will have, however, to re-adjust in many ways his system of agriculture. To be successful he will have to put more brains, energy and capital into his work; and in this we hope that the larger landowners will, like the "gentlemen" farmers of England of days of yore, take the lead in restripping and consolidating their holdings, and in developing the capacities of their own estates. It will be the duty of the department of agriculture to play its part by placing at their disposal the best possible scientific and practical advice, and in the shortest possible time. I am confident that the Government of this country will play its part well, and that the *laissez-faire* policy, formerly adopted to the detriment of agricultural development in some countries in the West, will not be followed by statesmen in India.

Of the value of the work accomplished by the Department of Agriculture in India within the last 13 or 14 years the Indian Industrial Commission has written as follows:—"The striking financial results which followed quickly and directly after the employment, from about 1905, of scientific specialists in agricultural research, demonstrate the wisdom of investing in modern science." This is the unbiassed opinion of a body of men who had considerable opportunities of studying the facts on which they based their conclusions. The work which the department has already accomplished is undoubtedly adding annually to the farming profits of the country a sum which exceeds its total annual expenditure many times over. The rate of advance, moreover, is likely to be very much greater in the near future than it has been in the past; for we now have a background of exact knowledge available which gives us a most useful basis for future progress. We have behind us, moreover, an enlightened government which has set its seal of approval on the work already accomplished, and which has determined to make ample provision for further expansion.

The achievement which has perhaps appealed most to the public is the introduction of superior varieties and strains of seed of the principal staple crops. To take only three of these, namely, cotton, wheat and rice, there is reason to believe that approximately two and a half million acres of improved varieties of cotton, and one each of wheat and rice, are already being grown. If the extra annual profit accruing from the cultivation of these were only two rupees per acre even, it would mean in the aggregate a total extra profit of approximately 90 lakhs of rupees, which far exceeds the total annual expenditure on all the departments of agriculture in India; but the actual extra profit from the introduction of improved varieties of these three crops is at least four times the amount which I have stated. This, moreover, is only a fraction of what has already been achieved, for the activities of the department now extend over a wide field including not only crop improvements, but the introduction of better and more intensive methods of cultivation all round. The introduction of a one per cent. improvement here and of a two per cent. improvement there is, in the aggregate,

adding largely to the wealth of the cultivator, and is fitting him for further progress. It is evident from what has already been accomplished that the department should, within twenty years, be in a position to introduce improvements which will add many crores of rupees annually to the farming profits of the cultivators.

The extent to which future progress can be guaranteed will very largely depend on the measures adopted by the Government of this country to secure an adequate staff of first class specialists in agriculture and the sciences allied thereto. We want the very best brains which the universities of the West can turn out, to help in the solution of India's agricultural problems, and to help in training Indians for this great work. Nor should time be wasted in getting these, for to train research men and original experimenters effectively takes many years, and such men even when fully trained cannot reasonably be expected to produce results till after years of careful investigation as a rule. Owing to the present shortage of staff our work is being carried on under great difficulties, and progress is retarded thereby. The value of the improvements already effected by a small staff has no doubt been surprisingly great; but let us not forget that up to the present we have tackled only the most obvious lines of improvement. We have merely scratched the surface so to speak; for the new knowledge which is to add tangibly to the profits of the cultivator we shall have to dig deeper. We have not as yet, for instance, given much attention to the question of cattle improvement by better feeding and breeding. Personally I am of opinion that this is one of our most hopeful fields of investigation, and I am confident that wonderful improvements can and will be effected within the next twenty years.

Much has already been accomplished in the way of improving the staple crops of the country by selection and hybridization, and this has paved the way for further improvements by better tillage methods and manuring: but for better cultivation we require better implements. Some thousands of improved ploughs, cane mills and other implements are now in use in rural India; but the existing demand is, I am sure, a mere fraction of what it will be in the near future. It is the duty of the department to see that this growing

demand is met satisfactorily. It is its duty, too, to assist manufacturers in devising suitable implements; to induce agricultural associations and unions to start depôts for the demonstration, sale, hire and repair of types suitable for the tract for which they are required; and to assist purchasers in setting up plants, if necessary. But here again we are at present handicapped for want of a staff of specialists. Some provinces have not yet obtained the services of an Agricultural Engineer, with the result that duties which ordinarily fall to such an expert are entrusted to Deputy Directors, very few of whom have had any training in mechanical engineering. We urgently require for each province an Agricultural Engineer to help to devise and set up improved types of agricultural machinery; and we want to get implements of the type required manufactured on a large scale in this country.

Much of the cultivated land in India has almost reached the maximum state of impoverishment; a great part of the cattle manure, which ought to go back to it, is burnt as fuel; and other available manures have not yet been used extensively. Indian soils over large areas have thus been starved for centuries, and are hungry, and therefore very responsive to manuring. It is largely due to the judicious application of water and manure that the crops obtained on Government farms are so much better as a rule than those of cultivators in adjoining villages. The testing of green manures, oilcakes, bones, fish, mineral manures, etc., and the study of their relation to bacterial life in the soil have been started. The results already obtained indicate the great need there is of inducing the cultivator to do everything in his power to conserve his farmyard manure, and to supplement it by using other available manures such as bones, oilcakes and green manures. In this the department can, and is giving him valuable assistance by advising him as to the kinds and quantities to apply, and by helping him to organize depôts for the sale of manures which can be used economically. It can assist, too, in establishing fuel reserves for the supply of fuel to villages; for want of such reserves cultivators over the greater part of India are compelled under existing conditions to use the dung of their cattle for fuel. There is no other course open to them at present.

The damage done annually to our staple crops by fungal diseases and insect pests is enormous. Here again we have a promising field of investigation which, for want of staff, we have not as yet been able to explore at all fully. Much has been done no doubt in the way of studying the life-histories of these diseases and pests; but with the limited knowledge at our disposal we are not yet in a position to recommend remedial measures except in a very few cases.

The conditions for fruit-growing in India are most favourable, and the subject is now beginning to get some attention from the department; but here again for want of experts in fruit-growing the work is at present relegated to men who have no special knowledge of the subject. The whole field of agriculture, in short, is still bristling with unsolved problems, which cannot be investigated effectively for want of trained specialists in the different branches of agricultural science involved.

The degree of specialization and of intensive concentration required for sound research in the different sections of the department is not possible at present. The circle of the average Deputy Director of Agriculture, for example, is so large and his duties so manifold that he can devote only a small fraction of his time to experiment and research without which real progress is impossible. From the results already obtained by our botanical experts, who have devoted attention to the improvement of the staple crops, there is but little doubt that it would pay handsomely to employ in each province a sufficient number of first class botanists to deal with all the more important crops; and the number of crops allotted to any one man should not ordinarily exceed two. There are undoubtedly problems enough in each province to occupy the whole time of several such men. To put one man in charge of more work than he can do efficiently is, in short, false economy, and this applies not only to Deputy Directors and Botanists, but to other experts as well. In every section the men employed are too much distracted at present by the great variety of problems which they have to tackle. So long as we are understaffed, moreover, it will be impossible for experts to give their assistants the specialized training

which is so necessary in the interest of efficiency. Farm Superintendents should, for example, be trained in experimentation, plant improvement and other lines of work entrusted to them before they are put in charge of experimental stations; and the men to be put in charge of demonstration and organization work should similarly be specially selected and trained for that class of work.

If we neglect to make adequate provision for experiment and research, we shall sooner or later find ourselves in the position of having nothing new to teach the cultivator; if given an efficient staff on the other hand, there is reason to believe that it will become increasingly easy to get him to adopt our teaching; for as a result of the work which the department has already accomplished his confidence has been gained to some extent, and he is now more willing than ever he was to make use of new ideas. To get that teaching adopted in the shortest possible time, we shall require many more government farms, and a more complete district organization, including taluq agricultural associations and unions, working under the guidance of the department. Each taluq or tahsil of a province should have its own government farm to which cultivators could come for help and advice. From these farms they would get their supplies of improved seeds, manures and implements; and agricultural literature of interest to them might also be stocked there. The taluq farm would be the centre for the meetings of the taluq agricultural association and for agricultural shows. It would be the centre, too, for agricultural education. Each farm might have its own agricultural school where the sons of landholders could be trained in the practice and principles of agriculture. The villages of the taluq might be divided into groups of ten or more, each group constituting an agricultural union which might have its own co-operative shop or depôt for the supply of seeds, implements, manures, agricultural literature, etc. The taluq agricultural association would consist of the office-bearers of these agricultural unions, while the members of the agricultural union would be the representatives of the ten or more villages included in the union. These unions would arrange for the sale and hire of implements in the villages and for the sale and distribution of other articles stocked

in their depôts. Each village of a union might have its own seed farms, its own stud bull or bulls, and its own fuel reserve. To control this organization efficiently it would be necessary to have a managing committee for each district with the Deputy Commissioner as chairman and the Deputy Director of Agriculture as agricultural adviser. The non-official members of the committee might consist of representatives elected every year by the taluq associations. The duty of the committee would be to define the policy to be followed by the taluq associations and unions controlled by them, and to allot funds for the demonstration work carried out by the unions. In order to provide money for this work each union could be called upon to contribute part of its profits to a general fund. District and taluq agricultural agencies organized in this way would be the medium through which legislative measures for the advancement of agriculture and the amelioration of the people would be carried out. Through these agencies one or more model villages with consolidated holdings, sanitary houses, schools, trim fences and serviceable roads could be laid out and run as object-lessons for the whole taluq. A system of demonstration and co-operation run on these lines would, I believe, help to break down the barriers which at present stand in the way of progress.

In conclusion, I would ask whether it is too much to expect that within twenty years the department if adequately staffed will, by patient, concentrated, and intensive investigation, have accumulated a body of knowledge in every branch of agriculture which may benefit India to the extent of many crores of rupees annually. And is it too much to expect that, by working with and through the people, it will be possible to get them to apply that knowledge? In the past the department has had its successes and its failures, but its successes have been far greater than Provincial Governments ever anticipated. An era of still greater accomplishment lies ahead of us. Our successes of the future will, I am confident, surpass our highest expectations. The great task of reconstruction which lies before us is well worth all the energy and brains we can put into it; for on the development of her agriculture depends not only the prosperity of India's many millions of agriculturists, but to a great

extent the lot of those engaged in other industries dependent on agriculture. Increased production will help to banish famine and poverty from the land, and to bring us near the realization of our hope, namely, to make India "a garden ringing with cheerful and contented life, with smiling fields and food in plenty."

SOME ASPECTS OF PLANT GENETICS.*

BY

W. BURNS, D.Sc.

Economic Botanist, Bombay.

ABOUT a month ago I received from the Secretaries of this Congress the invitation to take the place of Professor Fyson of Madras as Chairman of the Botany Section. You will, I am sure, join me in expressing our deep regret that Professor Fyson is prevented by ill-health from joining us. We miss him, and we miss his address, but we hope that on some future occasion we shall have the pleasure and instruction which a pronouncement by him is sure to afford. Meanwhile, we wish his speedy return to health.

In the very short time at my disposal I have attempted to put together a few thoughts on "Some Aspects of Plant Genetics." The scientific study of plant genetics is not of very ancient date, and, in this country, the work done is still of moderate dimensions. There is, therefore, some possibility of taking stock of our achievements and of estimating future progress in this branch of botanical science.

I am not forgetful that this is the section of pure botany, and that matters affecting agriculture and applied botany are dealt with by another section of this Congress. But I myself, in my professional capacity, am somewhat of a hybrid between a pure and an applied botanist, an F_1 hybrid, if one might so express it, with applied botany partially dominant. I trust that the partially

* Presidential Address to the Botany Section of the Seventh Indian Science Congress, Nagpur, 1920.

recessive character of pure botany may in this address be a little in evidence, even if tinged and modified by the stronger allelomorph. In this connection I would quote the following words ¹ of Professor John M. Coulter at the Baltimore meeting last year of the American Association for the Advancement of Science :

“ In the days ahead, the botanist who remains narrow will be stranded. We must recognize in every field of botany an important factor in the solution of problems. A man is expected to think his own field the most important, but if he thinks other fields unimportant, he has blocked his own progress and is bound to move in ever narrowing circles. One of the demands upon us, therefore, is to cultivate the synthetic attitude of mind ; to develop about our own specialty a penumbra of the botanical perspective. In other words, botanists must cease to be provincial, they must not be citizens merely of one small group, with no larger contacts, but citizens in the world of science. We must not remain persistently in the narrow valley in which our work lies, but we must get on to the mountain top often enough to realize the perspective.

“ The new opportunity demands this ; in fact, it was this that created the new opportunity. This means that we are to see to it that botany is recognized as the greatest field for universal service. Medicine holds that opinion now in public estimation, simply because it ministers to the unfortunate, but they are in the minority. Botanical research underlies an essential ministry to all. Disarticulation of botany from its practical applications has been most unfortunate and must not be continued. What we have failed to do is to establish the contacts between science and practice, to indicate the possibilities of every advance in knowledge in the way of public service.

“ This is very far from meaning that every investigation should have an obvious practical application. Research must be absolutely free, stimulated only by its interest in advancing knowledge, but the importance of fundamental knowledge in solving practical problems should be emphasized at every opportunity.”

¹ *Science*, April 18, 1919, pp. 364-365.

Do not, I pray you, take these words which I have quoted as a criticism. I pass them on to you as a stimulus to that broad scientific scholarship and healthy co-operation which in these specialist days is all the more necessary. And I would also remind you that while the specialist brings the material, it is the scientist of larger outlook who can from special facts build up those generalizations that give coherence, meaning and power to our knowledge. Different men have different talents, one may be an ideal investigator and another an ideal interpreter, but the investigator will be none the worse of a knowledge of what is going on in branches other than his own, nay, he will bring his rough material at least a little hewn and squared for the final building.

Plant genetics (or the study of heredity in plants) is one of those subjects in which fundamental scientific truths discovered or in process of discovery by pure scientific workers have been of immediate value in their practical application. It is, however, the case that the progress of research in genetics is in advance of the degree of use to which the truths discovered can be put. There is no fear of genetics degenerating into a mere mechanical art, if such there be. Again, it must be remembered that much of the earlier material for the study of genetics came from the records and experiments (crude though both were) of men who were not scientists, but practical breeders. Genetics, therefore, is one of those branches of science where, if anywhere, there should exist the most understanding and cordial co-operation between the pure and the applied scientific workers.

Let us look for a little at the historical aspect of plant genetics. I do not propose to repeat in detail facts which are so well put in the various histories of botany now available. The citation of a few names will serve to recall to you the general trend of work in the past. Previous to or contemporaneous with Mendel (whose main work, you recollect, was published in the middle of the nineteenth century) we have among practical breeders Van Mons of Louvain, who originated many varieties of pears; Knight of Britain, also a horticulturist; Shirreff, a Lothian farmer and originator of valuable varieties of cereal crops; Cooper, an American and a discoverer

of the benefit of selection as against mere "change of seed." Among pure scientists I may cite the names of the hybridists Kolreuter and Gärtner, assiduous experimenters; Charles Darwin, than whom no more painstaking or successful compiler of information ever existed; and lastly Mendel himself. With the re-discovery of Mendel's work and the fact of its standing the test of repeated experiments began the new era in the study of heredity. The term Genetics, happily devised by Bateson, is now applied to this new branch of biological science. Bateson, Punnett, Biffen, the lamented Darbishire and others have built up this branch of the science in Britain. America provides a legion of enthusiastic workers whose productions bid fair to outstrip those of any other nation. On the Continent there are many pioneer and famous workers whose names are household words wherever biology is studied. A glance at the membership of the International Conference of Genetics will refresh your memory. In India such work as has been done in plant genetics has been mainly (but not entirely) due to the botanists of the Department of Agriculture. There is no reason, however, why such work should be confined to them, and every reason against it. On account of their being members of an agricultural department their work on genetics is naturally confined to plants of economic importance. There are thousands of other plants presenting new and fascinating genetic problems that would amply repay the research of those who are not bound to deal only with agricultural plants. And, again, there is no reason why botanists of the department of agriculture should not welcome co-operation in the study of agricultural plants from those not in the department. Professor Fyson¹ some time ago published a useful paper on heredity on cotton, and I propose in a later part of this paper to put before you some problems in which I believe all can lend a hand. From the side of practical usefulness, or from the side of the search for fundamental truth, there is a large field in India for genetical investigation. We have the added advantage of being able to grow in the open air many plants that can live only in glasshouses in Britain and most parts

¹ Fyson, P. F. *Memoirs of the Dept. of Agriculture in India, Botanical Series, Vol. II, No. 6.*

of America and the Continent, and therefore a great incentive to the study of such plants.

An additional reason for the study of plant heredity experimentally by non-agricultural botanists is the fact that the subject of heredity in plants and animals now figures in the science syllabus of most of the Indian Universities. Actual material is necessary for the instruction of the student and the enlightenment of the teacher.

This brings me to the second aspect of plant genetics with which I desire to deal, namely, its educational aspect. At this stage in the world's progress and in the progress of India, it is surely unnecessary for me to insist on the desirability of training in science as an essential part of all education. Yet old prejudices die slowly. The eloquent words of Huxley¹ put the matter concisely, and are worth quoting: they serve once again to bring before us the main end that the study of plant genetics and of other sciences ought to serve in education.

“Yet it is a very plain and elementary truth that the life, the fortune, and the happiness of every one of us, and more or less of those who are connected with us, do depend upon our knowing something of the rules of a game infinitely more difficult and complicated than chess. It is a game which has been played for untold ages, every man and woman of us being one of the two players in a game of his or her own. The chessboard is the world, the pieces are the phenomena of the universe, the rules of the game are what we call the laws of Nature. The player on the other side is hidden from us. We know that his play is always fair, just and patient. But also we know, to our cost, that he never overlooks a mistake, or makes the smallest allowance for ignorance. To the man who plays well, the highest stakes are paid, with that sort of overflowing generosity with which the strong shows delight in strength. And one who plays ill is checkmated—without haste, but without remorse.

“My metaphor will remind some of you of the famous picture in which Retzsch has depicted Satan playing at chess with man

¹ Huxley, T. H. *Lay Sermons, Essays and Reviews*, 1870, pp. 36-37.

for his soul. Substitute for the mocking fiend in that picture a calm, strong angel who is playing for love, as we say, and would rather lose than win—and I should accept it as an image of human life.

“ Well, what I mean by education is learning the rules of this mighty game. In other words, education is the instruction of the intellect in the laws of Nature, under which name I include not merely things and forces, but men and their ways ; and the fashioning of the affections and the will into an earnest and loving desire to move in harmony with those laws. For me, education means neither more nor less than this. Anything which professes to call itself education must be tried by this standard, and if it fails to stand the test, I will not call it education, whatever may be the force of authority or of numbers upon the other side.”

It behoves us botanists, as enthusiastic believers in this doctrine, to push it at every opportunity. In our capacity as teachers, members of the governing body of a college or a university, or merely as private citizens we should do our best at every turn to get this idea worked into the fabric of Indian education which still suffers from the very faults against which Huxley inveighed. We desire above all things firmly to establish in the human mind that belief in causation, the inevitable chain of events, that makes a man free of superstition, able to weigh evidence and arguments, and amenable to reason. Such characters make for good citizenship and for personal and business morality. I would not weary you with quotations, but I would commend to your attention the very full treatment of this matter given by Karl Pearson, himself a geneticist, in the first chapter of his “ Grammar of Science.” The study of genetics is of value also as an introduction to sociology. Eugenics is the genetics of the human race. In genetics of plant or animal, problems of heredity and environment meet the student at every turn and the methods of attacking these are of use in his further work in sociology and eugenics. We desire, therefore, for these reasons to broaden the circle of those who appreciate genetic laws, and this can be done only if genetics forms a part of education.

I am not prepared to give a dogmatic opinion as to the stage at which genetics should be introduced into education, but I would observe that a teacher, himself trained in genetics, will be able in the course of an ordinary school Nature-study course to lead his pupils to observe some of the salient facts of heredity and environment. Caution and tact are, of course, essential. It will not do at all if we find the said teacher expounding Mendelian ratios to his bewildered class. But there are many facts of variation, a great many of adaptation, and a certain number of inheritance that can be quite well employed.

In our college and university courses the matter should be dealt with as fully as possible, and that "possible" can be very full indeed. This can only be, however, if the college or university is provided with some place where plants can be multiplied, reared and observed in successive generations. A *sine qua non* of a modern botanical installation ought to be a breeding garden including a plant house for plants that need protection, and if no other space is available, some part of the existing botanical garden should be given up to this purpose. The teacher must, of course, be able to grow his plants successfully. Although he may not be much of a gardener to begin with, the failures of one season will help him in the next, and it will not be long before he can grow anything with roots, and teach his students to do the same.

As one who has had a little experience in the teaching of plant genetics as part of a college course, I may be permitted to indicate one or two important points and some difficulties in this teaching.

For the study of variation we are surrounded by endless material. The leaves of the fig, mulberry and other trees give us examples of extreme leaf variation in the same tree. Any field of an annual crop will provide material for the study of variation between individual plants in height, colour, productiveness, etc. The students should weigh or measure a series of natural objects and the total results of the work of the class can be put together and plotted to show the frequency curve. Seed of extreme and mediocre samples from self-fertilized plants can be saved for the study of the next generation. Without some such practical introduction I have

found it difficult to get men to understand the curve of frequency and, as its explanation must necessarily come very early in the whole subject of genetics, inability to grasp its significance means disheartenment and cessation of interest and progress. I am inclined to think that the more mathematical part of plant genetics should be left to a little later in the programme. If too much of this is given at the start the student is both frightened and bored. He asked for plant genetics, and behold mathematics. After some of the more interesting work we can again recur to the mathematical aspect and the student will be more able and willing to deal with it.

A keen look-out should be kept for mutants, so that students may see actual examples of these. Unless one knows the pedigree of a given culture, one cannot, of course, say that a given aberrant plant is a mutant, but aberrant plants found in otherwise homogeneous cultures where vicinism is unlikely may be called mutants unless their posterity shows otherwise. Ornamental garden annuals are the last material to be used for this study as they are the result of long processes that probably included crossing and hence an aberrant plant may be merely the result of a heterozygote splitting.

The study of natural self-pollination and cross-pollination can be carried out with ease on any large-flowered plant. The Malvaceæ present an admirable series for this purpose. I would solicit your attention to the admirable teaching material that may be extracted from certain memoirs of the agricultural department dealing with this subject.

Plants of the Malvaceæ and plants of the Leguminosæ can be used for hybridization practice and to illustrate the law of Mendel. It is, of course, necessary to be sure that one is dealing with pure homozygous parents, and this can only be ascertained if one breeds the plants for at least a generation from self-fertilized seed.

Maize offers many interesting and easily demonstrable points. There is also a large literature about the genetics of maize. In maize, crosses between plants with different endosperm show the xenia effect in the cob of the female parent and the selfed F_1 plant will show the Mendelian ratio in its cob. A cob with many types of seed on it, not an uncommon phenomenon, offers an excellent

starting point for the isolation of its constituent races. The only difficulty about maize is its tendency to degenerate when repeatedly self-fertilized. Its great advantage, in addition to those mentioned, is the great number of generations that can be crammed into one year. In the dry season the plants need a very heavy manuring to prevent premature flowering and perhaps the failure to form female inflorescences.

For the expounding in the lecture room of Mendel's law and its effects various devices have been invented. Here is one that I have been instrumental in introducing. The apparatus is two packs of ordinary playing cards. These are familiar objects to the students, and their appearance on the lecture table of a staid professor excites a certain amount of amusement and the necessary interest. The black and red are supposed to be the allelomorphic pair, black being dominant to red. The union of a black and red gamete is easily shown and the character of the F_1 hybrid is shown by a black card hiding a red one. The gametes of the F_1 hybrid are represented by a pack each. One pack being the female and the other the male gametes. The essential part of the demonstration is the very thorough shuffling of each pack. I usually get three students in succession to shuffle each pack. In fact I let the students carry through the whole thing so as to avoid any appearance of any other agency than chance. One card is then taken from each pack and each pair is classed under one of four heads Black-Black, Red-Red, Black-Red, Red-Black. In theory there ought to be 13 under each head. This fairly often comes out. If it does not, one has an excellent opportunity for explaining the nature of chance, and showing how with a larger number there is a greater likelihood of gaining the theoretical ratio. Coloured counters or beads may be similarly used. The mating of plants differing in two pairs of allelomorphs can be worked out by using beads differing in colour and in shape, tied together in the appropriate pairs. These may then be mixed in a bag and brought out in a manner similar to that used for dealing with one pair of allelomorphs.

An interesting method of explaining Mendelian phenomena as distinct from demonstrating them is that described by Professor

Loye Holmes Miller¹ of the State Normal School, Los Angeles, California. He reasons thus :

“ Practically every high school graduate has had at least a year of algebra and has learned by rote the square of $a + b$. Whether or not he remembers that $a^2 + 2ab + b^2$ represents all the possible combinations of the two factors, he is in a position to be reminded of that fact and to take the first short step into the unfamiliar. If a and b represent the two types of gametes produced by the heterozygous parents F_1 , then $a^2 + 2ab + b^2$ represents all the possible progeny in the F_2 generation. Factors of second power represent pure strains, because the determiner is the same from both parents. Conversely, factors of the first power represent heterozygotes or the union of unlike determiners.

“ The greatest service of the method appears when the two sets of allelomorphs are combined. The student has learned to multiply $a^2 + 2ab + b^2$ by the expression $x^2 + 2xy + y^2$. He will perform the operation as one familiar to him and he can readily be taught to recognize the four pure strains $a^2 x^2, a^2 y^2, b^2 x^2, b^2 y^2$. Suppose a and y represent the dominant characters and b and x the recessives, emphasizing the fact that the dominant is effective whether appearing as a first or as the second power. Suppose a represent tallness and y represent red flower in a plant. Gathering the results of the multiplication according to visible attributes we have four columns representing the Mendelian ratio 9 : 3 : 3 : 1.

Tall red 2 a^2xy 4 $abxy$ 2 aby^2 a^2y^2 <hr style="width: 80%; margin: 0 auto;"/> 9	Tall white a^2x^2 2 abx^2 <hr style="width: 80%; margin: 0 auto;"/> 3	Dwarf red b^2y^2 2 b^2xy <hr style="width: 80%; margin: 0 auto;"/> 3	Dwarf white b^2x^2 <hr style="width: 80%; margin: 0 auto;"/> 1
--	---	--	---

This is only one of many devices all alike fundamentally, but it has the great value of utilizing a familiar process. Many times I have seen it clear up a badly fogged situation. It is worth trying on the discouraged pupil at any rate.”

¹ *Science*, February 7, 1919, pp. 148-149.

I believe it to be an excellent method to have large scale pictorial records of the progeny of a selection or a cross through several generations and hang them on the wall of the genetics laboratory.

Practical work in a genetics course must obviously run for two years and must involve the study of variation, the isolation of types, the selection of plants and the study of their progeny, the technique of hybridization, the study of the progeny of hybrids, and the methods of recording breeding work.

Much observation of a completely new type can be done on floral mechanism and floral physiology. The observation of the time of opening of flowers, time of anthesis, time of ripening of the stigma, fertility and longevity of pollen, period between pollination and signs of fertilization, etc., afford admirable educational discipline. The observation of the opening times of some flowers may involve getting up once or twice during the night, and this should not be shirked by advanced students.

For students who intend to present an M.Sc. thesis I can imagine no more fertile subject than plant genetics, provided the material is carefully chosen and the work well guided.

We are now fortunately much better off for text-books than we were a little while ago. There is a new edition of Punnett's "Mendelism," and Darbishire's book on the same subject is of great use. From America we have the useful "Plant Genetics" of Coulter and Coulter, also Babcock and Clausen's "Genetics in Relation to Agriculture," and Coulter's "Fundamentals of Plant Breeding." There are at least two journals devoted to its more severely scientific side, and we have the invaluable "Journal of Heredity," the organ of the American Genetic Association, which is a priceless possession to the teacher of genetics. I notice that Babcock and Clausen have made free use of material that has appeared in its pages.

I think I have said enough to demonstrate the value of plant genetics as an instrument of education and to show how this instrument may be wielded. The study of plant genetics lets the student see the plant in action and it allows him to play with life in a manner afforded by no other branch of the science of botany.

Plant genetics is a subject, however, that can be easily spoiled by putting the theories first and the evidence second, as is too often the practice. I would quote to you in this connection the following words of one whose assistant I had the honour to be—Dr. Frederick Keeble¹:

“The first duty of a teacher (is) so to select and present common facts that the essential generalizations which cohere them into a scientific system, either suggest themselves to the mind or, at all events, appear natural and convincing when the teacher is compelled by the defectiveness of his method or the indifference of his students to expound.”

In concluding our study of this aspect of the question let me put before you as a goal that which McCurdy² informs us was the aim of Leonardo da Vinci, that great, free spirit of the 15th Century: “It was the cramping fetter of mediæval tradition upon thought which Leonardo tried to unloose. It was his aim to extend the limits of man’s knowledge of himself, of his structure, of his environments, of all the forms of life around him, of the manner of the building up of the earth and the sea and the firmament of the heavens. To this end he toiled at the patient exposition of natural things, steadfastly, and in proud confidence or purpose.”

Plant genetics, in its utilitarian aspect, means the production of new and better plants, and the keeping of these up to standard. This aspect of the work has been very fully reviewed by Sir Daniel Morris in his address to the Botany Section of the British Association for the Advancement of Science last year. There are one or two additional points, however, that I should like to put before you, both as regards work done and as regards possibilities for further work.

Bergson,³ treating of the living body in general, says:

“It is an *individual*, and of no other object, not even of a crystal, can this be said, for a crystal has neither difference of parts nor diversity of functions. No doubt it is hard to decide, even

¹ F. K (eeble) in *Nature*, September, 1919, p. 47.

² McCurdy, E. *Leonardo da Vinci's Notebooks*, 1906, p. 10, Introduction.

³ Bergson, Henri. *Creative Evolution* (translation by Mitchell), 1911, p. 10.

in the organized world, what is individual and what is not. The difficulty is great, even in the animal kingdom ; with plants it is almost insurmountable. This difficulty is, moreover, due to profound causes, on which we shall dwell later. We shall see that individuality admits of any number of degrees, and that it is not fully realized anywhere, even in man."

My preceptor, Professor Bayley Balfour, puts the same idea in a formula by stating that the plant is a *colonial organism*. Its various parts are to some extent independent of each other, and isolated parts can reproduce those missing. It is not to be wondered at, therefore, that we find these parts varying among themselves, nor that such variations are at times inherited. I refer, as you perceive, to *bud variations*. It is a well-known fact that a bud on a tree may give a branch the leaves, flowers and fruit of which are different from those of the rest of the tree, and that these peculiarities may be transmitted to the next generation either vegetatively or sexually. Varieties of sugarcane have been observed to arise by this method, and changes in the fruit of trees have been observed to follow such bud mutations. It is particularly with reference to the study of bud variation in Indian fruit trees that I think a great deal of work can be done. These variations may be useful or harmful from the practical point of view. Care is needed in weeding out the harmful and preserving the useful variations. Let me cite to you, as an example of the kind of work I mean, what has been done on the Washington Navel Orange, a variety which is the mainstay of the Californian citrus trade.

The following facts are culled from articles that have appeared from time to time by fruit experts in the pages of the "Journal of Heredity."¹

The navel orange, as its name implies, is one that has a peculiar umbilical protuberance at the stigmatic end. The Washington navel orange originated at Bahia, Brazil, as a bud variation of the

¹ *Journal of Heredity* : Vol. VI, No. 10, "Washington Navel Orange," by A. D. Shamel ; Vol. VII, No. 2, "Bud Variation," by A. D. Shamel ; Vol. VII, No. 10, "Forgotten Bud Variations," by L. B. Scott ; Vol. VII, No. 11, "Co-operation in Production of California Grape Fruit, *anon.*

Portuguese variety of orange, *laranja selecta*, or the select orange. This variety, says Shamel, whom I quote, was undoubtedly introduced into Brazil very soon after the colonization of that country. According to V. A. Argollo Ferrao, one of the agricultural officials of the country, the navel orange appeared as a bud variation of the *selecta* variety and was discovered and propagated by a Portuguese gardener at Bahia about 1822. This account of its origin has been confirmed by all other available information.

Here, then, we have an authentic case of a valuable fruit arising by bud variation. The orange is seedless, has this peculiar navel, and is of excellent quality and appearance. The Bahian navel orange as above described was introduced into the United States through the efforts of William Saunders, then Horticulturist and Landscape Gardener for that division of the Patent Office corresponding to the present United States Department of Agriculture. The first consignment of trees died on the way, but the second got through, though in poor condition. Buds from these were propagated on seedlings of the same variety grown from seed that Saunders had acquired separately. Trees were ready for distribution in 1873 and a Mrs. Tibbetts of Riverside, California, got two of these. From these two trees has sprung the Californian industry, for the budwood from new plantations was taken from them. In 1915, there were about 100,000 acres under this variety in the State. So far so good. We have here an excellent variety, originating as a bud variation, propagated by vegetative methods, the whole population of these trees in California forming two "clones." A "clone" is a race propagated vegetatively from one source. One would have thought that the growers' troubles were ended.

Very far was this from the case. It soon began to appear that within the variety now named Washington Navel by the growers there were various types of tree, distinguished by habits of growth, density of foliage and other characteristics. In addition, there appeared to be a steady and unaccountable deterioration in the trees of new plantations and in the fruit of these. Careful investigation by Shamel revealed the fact that there were eleven common types of the navel orange in California in 1909, and of

these the most undesirable from the standpoint of fruit production were those showing the greatest vigour of growth. These undesirable trees produced in great quantity thick succulent branches, the so-called suckers, from near their base, and these branches had been freely used, nay, actually selected as the source of budwood for the preparation of new stock. The reason is not far to seek. As every gardener knows, one wants a big bud, from a round stem with an easily separable bark, and these requirements were met by the sucker growth. The evil effect can be easily imagined, namely, the new plantations were nearly filled with these "drone" trees, and Shamel records cases of plantations in which as many as 70 per cent. of the trees were of this bad type.

Now whence had these eleven types arisen, including the evil drone types? Obviously from further bud variation, for the orange is seedless and is never propagated except by buds.

What was the remedy? Obviously, to select the best of these variations and take budwood from that only. How was this best variation to be selected? On the same basis that one selects a good cow, by *performance*. Performance records were therefore kept for several years of the fruit production and quality of individual trees and blocks of trees, and on this basis trees for fruit propagation were selected. A drastic change was also introduced by using, for budwood, not the fat juicy sucker, but the wiry twigs just at the back of the fruit growth of the current year. This may seem bad horticulture, but it has in practice proved brilliantly successful, and Shamel states that a certain co-operator budded more than 13,000 orange seedlings with such budwood in 1914 and only two of these failed to grow.

The Californian growers of grape fruit (otherwise the pomelo) have gone a step further. In the grape fruit the same difficulty arose and the same remedies have been found successful. The Grape Fruit Club, one of the growers' organizations, has decided to eliminate from their groves all varieties except the Marsh (the most useful variety) and further to eliminate all Marsh except one type. By this means they will standardize the product of all the members of the club with great advantage to both producer and consumer.

Similar problems present themselves in the citrus groves of India. The gardener, and the plant breeder also, are sometimes apt to think that within a clone purity must reign and variation be abolished. The experience of those who investigated the Washington navel orange was, as we have seen, quite otherwise. A walk through any orange grove on this side of India will show you that here too bud variation does occur, and I commend its study to future investigators. Tree differs from tree, branch from branch and even, occasionally, fruit from fruit on the same branch. The matter is one of common observation among the illiterate cultivators themselves. There is here a clear field for an inviting and useful research, and we have a good lead from the American work as to how to deal with the problem.

Another phenomenon on which as yet little work has been done in India is that of the seedlessness of fruits. Seedless fruits are in many cases extremely desirable. The guava, for example, is spoiled by the multitude of extremely hard seeds that occupy such a large part of its pulp. There is a belief current among guava cultivators in Poona that repeated vegetative propagation of the guava tree will reduce the number of seeds. This belief was experimentally tested by my assistant, Mr. L. B. Kulkarni, L. Ag., who layered the guava repeatedly and tested the guava fruits got from each successive layer generation for number of seeds. This experiment was carried to the third layer generation without effect on the seed number.

Some years ago I advertised in several newspapers for seedless guava trees, and received many so-called seedless trees, all of which produced fruits bearing seeds. Races of guava trees do, however, vary immensely in the number of seeds produced, and a Sind variety, now recommended and propagated in the Ganeshkhind Botanical Garden, Poona, has a very small number indeed. It may be possible to get at this seedlessness by selection of trees or buds within this variety.

Another possible way of attacking the problem is by a cross between different species of the genus *Psidium* to which the cultivated guava belongs. A fruit-producing but seedless guava may in this

way be produced. This method has been tried by my assistants, but as yet without success.

Similar improvement is desirable in the custard apple (*Anona squamosa*), also an excellent fruit spoiled by large and numerous seeds.

The seedlessness of the cultivated banana (*Musa sapientum*) is a subject of interest genetically, especially considering the free seeding character of the wild species (*Musa superba*). Apparently fully developed seeds do occur occasionally in edible bananas, more especially in certain varieties. Fawcett¹ mentions that seeds were secured when the pollen of the red banana was dusted on the stigma of the ordinary banana at Hope Gardens, Jamaica, but that the hurricane of 1903 levelled the plantations before the seeds were ripe. Apparently there has been no further Jamaican experiment. Experiments made by myself and my assistants in Poona in 1916 showed that seeds were produced in small quantity in fruits of *Musa sapientum* when pollinated by pollen of *Musa superba*. The viability of these seeds was never tested as they were lost, and war work afterwards prevented the repetition of the experiment. Seeds occurring in the Mhaskel variety have been dissected by me and found to be mere hollow shells. It is an established fact that the fruit of *Musa sapientum* develops without the stimulus of pollen.

All this does not give us much light, however, on the cause of banana seedlessness. Tischler² found that three races of banana investigated by him had different chromosome numbers, namely, 8, 16, and 24. He found also that with increase in chromosome number appeared a derangement in pollen development. Abnormal tetrads and nuclei were thus formed, but some of these could give normal pollen tubes. The numbers of chromosomes given above were the reduced numbers. In somatic cells pro-chromosomes, by which name he called centres sharply defined by hæmatoxylin, scarcely ever indicated a diploid nucleus, but there was a tendency for two or more to fuse.

¹ Fawcett, W. *The Banana*, 1913, p. 18.

² Tischler, G. *Untersuchung über der Entwicklung der Bananen Pollens I*, Heidelberg, 1912.

I have made a considerable number of careful sections of the ovary of *Musa sapientum* at different stages of growth of the flower, but have failed to observe an embryosac. I was unable to complete this study owing to the war and to leave, but the whole indications were of a feebly developed or missing embryosac.

Beccari,¹ writing of the origin of the cultivated banana, says:

“The wild varieties are almost wholly seeds, but what pulp exists is sweet and agreeable. It therefore only requires some agent to inhibit the growth of seeds and promote that of pulp to produce good bananas. Effective causes are sterility produced by hybridization and improvement by asexual reproduction.”

Now this airy disposal of difficulties does not at all meet the hard facts of the case. We have already seen that in guava² repeated vegetative propagation for three generations does not alter the number of seeds. Second, I fail to see how you are to propagate *Musa superba* vegetatively, for in all the places where I have seen it, it produces no suckers. It may be different with other wild seed-bearing varieties, of course. Next, the question of hybridization. This is possible, of course, but no one has yet produced a seedless *Musa* from two seed-bearing species. This remains to be done. The abnormal nature of the pollen would seem to point to some great disturbance of the germ cells and this might possibly be due to a wide cross. On the other hand it might be only a mutation affecting chromosome number, like *Oenothera lata* from *O. Lamarckiana*.

The matter is, therefore, one on which we have no exact information, and is complicated by the statement of Baker² that *Musa Fehi*, which grows widely in Tahiti, is seedless at the lower levels of the forests but bears seeds when found at higher altitudes, say 3,000 to 3,600 feet.

I submit that the problem of seedlessness in fruit is one for the investigation of which much material exists, little work has been done, and great rewards are in readiness.

¹ Beccari, Odvardo. *Nelle Fineste di Borneo Firenze*, 1902, p. 611.

² Baker, J. G. *Annals of Botany*, VII, 204.

The question of the inheritance of sex in plants presents itself to us in our indigenous plants papaya (*Carica papaya*) and Indian hemp (*Cannabis sativa*). Just as in considering the question of seedlessness we very soon got away from the purely utilitarian aspect and found ourselves in the rarefied atmosphere of pure truth, so here also we very soon find that the practical application of the research awaits entirely the disinterested labours of the pure scientist. In the case of the papaya we at present can see no difference between the male, hermaphrodite and female trees until they flower. If some means of distinguishing them at an early date were found, much useless planting and much loss of labour, water and manure would be prevented. Or if a race of papayas could be produced with a very large percentage of female trees, a great boon would be conferred on tropical fruit growers. But both problems still await solution.

Investigation has been done by Higgins¹ and Holt in Hawaii, and by my assistant, Mr. L. B. Kulkarni,² L. Ag., in this country. The result of such enquiry up to date is about as follows: The papaya shows trees purely male, trees purely female, and several types of hermaphrodites. Of these hermaphrodites there are at least two clearly defined types, namely, (1) a type which produces occasional fertile flowers on a long peduncle bearing for the most part male flowers; (2) a type bearing fertile flowers of larger size on a short peduncle that may have male flowers upon it. The fruit of the second type is often elongated, and on account of the short peduncle is borne fairly near the stem. All these types may occur from one set of seeds. Moreover, in the lifetime of one tree there may be a change of sex. This may occur without any special apparent exciting cause or it may be induced by beheading the tree. Kulkarni observed one case of a tree that had completed the whole cycle of sex and come back to its original condition in its own lifetime.

Both in Hawaii and India experiments have been made in pollinating the ovary of a pure female tree with pollen from a

¹ Higgins, J. E. "Growing Melons on Trees." *Journal of Heredity*, VII, 5.

² Kulkarni, L. B. *Ann. Report, Ganeshkhind Botanical Garden, 1913-14, and succeeding years.*

hermaphrodite tree, with the object of getting a race with a large percentage of female trees. That one does get an increasing percentage is shown by results, but the limits of such breeding and the scientific interpretation are still unknown.

Again, there is something rather mysterious about the formation of the papaya fruit. One often sees a lone tree at a railway station or some out-of-the-way place, with apparently no male near it, and yet bearing fruit. In Ganeshkhind Garden we bagged a certain number of flowers to see if fruit set without pollination and it was found that it did. The seeds within these fruits were not viable.

There appears to be here some hint of parthenocarpy, and again much material ready to hand for a most fundamental research.

The ratio of the different types of tree from seed of known origin is also a matter requiring investigation.

To turn to the second example of bisexual plants, namely, *Cannabis sativa*. A most interesting series of experiments on the determination of sex in this plant was carried out by Ciesielski¹ in Lemburg between 1871 and 1878. According to his results, fresh pollen produces males and stale pollen produces females. I do not remember to have seen any recent repetition of this work to enable me to judge of its truth under modern conditions of rigid scientific control.

Changes of sex in hemp have been repeatedly observed, both without apparent external cause and with such.² Removal of the flowers does alter the sex of hemp, and while only a few male plants produced pistils, they constituted 14 to 21 per cent. of the total number of males reproducing flowers after the operation. It is quite probable that if the proper stimulus were used, says Pritchard, pistil formation could be induced in all males. He also states that the females were very responsive to the stimulating effect of flower removal. In fact, in the second year's experiments every female operated upon produced an abundance of stamens.

¹ Wester, P. J. "The Determination of Sex." *Journal of Heredity*, V, 5.

² Pritchard, F. J. "Change of Sex in Hemp." *Journal of Heredity*, VII, 7.

Schaffner¹ records a case of complete reversal of sex from femaleness to maleness in hemp with no special treatment.

This plant, therefore, deserves further study, and as it grows easily here, we should be the people to carry on that study.

One point comes out clearly in the discussion of the above facts regarding papaya and hemp, and that is that sex does not appear to be, in these cases, entirely a matter of zygotic constitution. It would appear that both are potential hermaphrodites as believed by Darwin and Strasburger, and again as pointed out by Pritchard.

Again, very little, if anything, has been done to test grape seedlings in this country, and yet when one considers the new varieties of value that have been thus originated in other countries one feels that here too is a promising and obvious field for work.

Among ornamental plants there also exists an untouched and attractive region for research and profit. We have many wild plants that would probably repay domestication and breeding. When one considers what has been done in a few generations with phlox and petunia one feels that many of our wild plants may hold similar possibilities. And when one sees to what miserable specimens uncared-for florist's plants can degenerate one looks through the other end of the telescope, as it were.

The production of horticultural seed in this country is an industry offering, I believe, great scope for the practical scientist or the scientific practitioner.

I have dwelt on the horticultural aspect of utilitarian plant genetics because it is one that is too often neglected, and yet horticultural products are a great part of the country's wealth and its gardens are æsthetic riches.

A word or two must be said regarding the relation of plant genetics to other branches of botanical activity. At present cytology is most intimately connected with plant genetics. The investigation of chromosome numbers, distribution, and arrangement

¹ Schaffner, J. H. "Complete Reversal of Sex in Hemp," *Science*, September 26, 1919, p. 311.

forms no small part of the knowledge which the geneticist must have in order to elucidate many points of his problems. The recent work by Arber and Beer, recently discussed and criticized by McLean,¹ on multinucleosis in the developing soma cell of the higher plants opens up an entirely new field of speculation. The value of the chromosomes in heredity and the meaning of nuclear fusion, whether of gametes or of somatic nuclei, are points which at one time appeared to be as settled as anything in science. They have now again come under the fire of rigid investigation, and we shall in all probability soon be able to chronicle further advances in our ideas regarding both these important matters.

In relation to taxonomy, genetics has a large part to play, a part on which genetics has as yet hardly entered. Genetics, we may truthfully say, is the experimental form of the study of evolution. In taxonomy our aim is to relate in groups such plants as are genetically connected. Up to date, on account of the mass of new material to be handled, taxonomists have based their reasoning chiefly on observation of individual generations either in a single habitat, or too often entirely apart from the habitat. The only real test of a variety is to grow it, and see if its characters are retained. It is necessary to test it also in varied environment and to see how far its new characters are inherent and how far due to environmental influence. It may seem at first sight as if this were a thing impossible, but it is not a thing which can or should be done all at once. There is, in addition, a fertile field for hybridizing existing species and varieties, when the origin of others may be elucidated.

To return again to genetics as the experimental form of the study of evolution. As such it must always take a central position in the study of life, for as Bergson has said, life is essentially a "becoming." Man has always been curious about the manner in which new forms arose, and in genetics we may get a long way toward knowledge of this point. You will observe I do not say why new forms arose. That is more a question of pure philosophy and

¹ McLean, R. C. "Sex and Soma." (Paper read before Linn. Soc., Lond., November 20, 1910.)

for its answer I know no better master than Henri Bergson, whose reasoned theory of the "vital impulse" is at once inspiring and encouraging.

We must clearly recognize the limits set upon our experiments and our generalizations by the nature of plants. On account of their food habits, their immobility and lack of consciousness, they offer themselves as easy material to even the unpractised experimenter. The possibility of keeping relatively large numbers under culture and observation enables us to gain facts regarding posterities and to keep a look-out for mutants which are the more likely to appear, the greater the number of plants grown. The large number of nearly related but diverse forms enables us to study inheritance in crosses between nearly similar varieties.

Wherein, then, is this material imperfect? Perfect it certainly is for itself, but we should beware of drawing conclusions regarding characters which have not been investigated, characters more developed in animals, or characters which appear to be more part of the life of the individual and less part of the material in which that life clothes itself. For as Darbishire¹, following Bergson, states:

"Let us now consider concisely the four main conclusions to which a consideration of M. Bergson's philosophy has led us:—

1. Time is the essential factor concerned in the fixation of the characters of organisms.
2. Life is perpetually creating the absolutely new; more is got out in the effect than is put in in the cause.
3. The performances of living things cannot be predicted mathematically.
4. The organism consists of an essentially vital part and of non-living constituent parts."

He goes on to say:

"His (Bergson's) conclusions with regard to life are untrue of Mendelian characters. This may mean either (1) that M. Bergson's conclusions are ill-founded, or (2) that the Mendelian characters

¹ Darbishire, A. D. "An Introduction to a Biology," 1917, p. 98.

are dead or, at any rate, appertain to the least vital parts of the organism. I believe the latter alternative to be nearer the truth. If it is nearer the truth, we have, I think, a clue which will enable us to relegate the Mendelian characters to their true position among the characters of living things ; and a suggestion which may enable us to determine without experimentation which characters are likely to behave in a Mendelian way in heredity and which are not. And it would seem, in general, that Mendelian characters are to be found amongst the contents of the retort and are not exhibited by the retort itself."

Again, the study of plant genetics supplies us with practically no data regarding the inheritance of instinct or intelligence. There are certain habitual actions, however, almost resembling instincts, *e.g.*, certain kinds of response to stimuli, whose inheritance in crosses might lead to some new knowledge. An interesting case would be the crossing of a right-handed with a left-handed climber, if such could be made.

Plant genetics, like other studies of heredity, has had two main tendencies, the biometric and the Mendelian. The former aims at the mathematical interpretation of the facts of mass inheritance, the latter at the scientific explanation of individual inheritance. The latter demands the intense study of single lines of inheritance, single plants, single characters. Of this nature is the work of Mendel and of this nature is the work of De Vries on *Oenothera*. It is a method that is essential in future work on the study of heredity in plants. Its intensity is increasing, for whereas in the time of Mendel it was sufficient to follow a single gross character, we now attempt to follow a single chromosome or a single chromomere. We here approach very near to the actuality of Clerk Maxwell's demon, who was supposed to be able to make selection between slowly and quickly moving molecules and thus alter the heat of two parts of a closed system.

This brings us to the question, "What do we actually know, and what can we actually do, in plant genetics?" We may truthfully say that the more we know the more complex does the whole situation become. Judging from recent researches some ideas

that have been dogmatically expressed by certain earlier writers are likely to require considerable revision. A state of uncertainty is likely to supervene on the first apparent state of stability.

But what do we know ?

The facts of variation in external form we can observe, measure and record. The causes of non-adaptive variation we do not know. I defy any botanist living to account for the variation in the lobing of the leaves of a single fig tree.

Concerning the distribution of fluctuating variation we know a good deal and can mathematically express it. The theory of its distribution at present seems to fit the facts. But there arises a difficulty in distinguishing fluctuating variation due to slight changes in environment from variation due to cumulative factors, especially where these mean small changes in quantitative characters. The doctrine of cumulative factors is, of course, still a hypothesis, but it is a matter of fundamental importance and deserves careful experimental study.

Mutations are repeatedly observed in pure cultures. In some cases gross changes in number or form of chromosomes have been observed. In a few cases mutations have been produced by altering the external conditions of the plant or the organ. In no case are the mutations adaptive. It appears proved that mutations are due to alterations in the germ plasm, but that the germ plasm can be got at appears also true. Recent work by Rawson¹ in South Africa shows that by selective screening a new form of *Papaver Rhoeas* has been secured and fixed. If this can be done by a mere variation of light on the externals of the plant, where is the theory of the sanctity of the germ plasm ?

The rôle of the chromosomes as carriers of the plant characters is a matter of some debate, especially in relation to sex. For the sex of plants, as we have seen, can be altered by artificial means altogether apart from the germinal character of the plant. The fact, however, that the male gamete is practically all nucleus and that male characters do appear in the hybrid is a strong argument

¹ Rawson, H. E. "Plant Sports Produced at Will." (Paper read before Linn. Soc., Lond., November 6, 1919.)

for the chromosome hypothesis. The arrangement of characters linearly on the chromosome is still hypothesis on the basis of certain experiments on *Drosophila*.

When we come to hybridization we have an enormous mass of facts capable of varying interpretations. Of Mendel's original theory we can say that as far as the cases dealt with in his experiments go it is true. But, after all, the truth of a theory is not its main virtue. As Duclaux ¹ remarked :

“Le propre d'une théorie n'est pas d'être philosophique et séduisante : elle n'a même pas besoin d'être vraie au sens absolu du mot. Il lui suffit d'être féconde.”

(The characteristic of a theory is not to be philosophical and seductive : it need not even be true in the absolute sense of the term. It is enough if it is fecund.)

Judged by this standard, Mendel's theory has been amazingly fecund. Hence the progress in twenty years, four of them occupied in a devastating war, is more than in the two hundred years previously, a marvellous phenomenon even when we allow for the improvement in apparatus.

Definite numerical ratios are obtained in many cases but not in all. Where such ratios are obtained, Mendel's law or some modification of it appears to apply. I have mentioned “some modification” and, indeed, there have been so much modifications and so many additional hypotheses (the presence-absence hypothesis, inhibiting factors, complementary factors, cumulative factors, linkage, crossing over) that one begins to feel a little uneasy and suspicious of a theory that needs so much adjustment. This suspicion is only to be dealt with by more and more experiment. Things may be, however, simpler than they look. The act may be simple, but we may, as Bergson ² suggests, be able to view it only as a patchwork. This ought in no degree to retard either our experimenting or our theorizing. It ought, indeed, to incite us to get a viewpoint ever higher and higher above the broadening area of facts.

¹ Duclaux. *Traité de microbiologie*, Vol. I.

² Bergson, H. *Creative Evolution* (translation by Mitchell), 1911, pp. 95-97.

We must, therefore, retain our rôle of keen-eyed watchers ready to pounce on any indication given by Nature in her own silent workings, and we must also perpetually ply her with questions in the shape of all manner of experiment. Our ignorance is great but so also is our hope.

SOME ASPECTS OF COTTON IMPROVEMENT IN INDIA.

BY

H. C. SAMPSON, B.Sc.,

Deputy Director of Agriculture, V and VII Circles, Madras Presidency.

Extract from para 4 of the Indian Cotton Committee's Report—Possibility of Indian cotton replacing American for Lancashire purposes :—

Extract from newspaper criticism on the Indian Cotton Committee's Report, headed "Lancashire Interest" :—

* * * * * * * *

“These cottons (of a staple up to 1 $\frac{1}{8}$ th) will only be capable of spinning up to 34s twist and 44s weft in the Lancashire mills, if the conditions of those mills continue as at present.”

“Exception is taken to the statement in the Report that cotton of 1 $\frac{1}{8}$ in. staple will spin 34s twist and 44s weft in Lancashire mills. It is asserted (by Lancashire) that the staple for these yarns must be 1 $\frac{1}{4}$ in. Only if the 1 $\frac{1}{8}$ in. staple were much more reliable than Oldham's experience shows it to be, would it serve. It would have to be absolutely even, and that is too much to expect of any growth.”

* * * * * * * *

How are we to reconcile these two opinions? The first is the considered opinion of the Indian Cotton Committee, which not only contained recognized experts from the cotton spinning industry of Bombay and of Lancashire, but had an opportunity of inspecting any Indian mills it wished to, as well as of taking and sifting evidence of practical spinners throughout India, and the second is the opinion now expressed by the spinners of Lancashire. What are the reasons for this difference of opinion? It may be that the Lancashire operative will not submit to as many stoppages for breaks in the

spinning of the yarn as the Indian operative. But this can hardly be the case, otherwise Indian yarn would be unable to compete with Lancashire yarn, which would necessarily be of much better quality. Is it that the Indian mills are better equipped than those of Lancashire? This again can hardly be the case. Up to the outbreak of war the number of mills in India, which spun the counts mentioned, were very few in number. It is not likely therefore that during the war, when necessity restricted even the renewals of existing mills, these could install machinery adapted for spinning the counts mentioned.

If we are to find an explanation to the difference between the two statements quoted, it seems evident that we must look for some other reason, and the following is suggested as the probable solution of the misunderstanding.

Lancashire is at a great disadvantage in judging cotton, because she is not a cotton producing country. This means that she never sees cotton until it reaches there in the form of pressed bales. It is much more difficult to judge the value of cotton after it has been ginned and pressed than before, and that this is so is shown by the reports received from England on samples of cotton sent from India. Such reports lay special stress on colour, freedom or otherwise of leaf, broken seed, etc. They may or may not state whether the staple is even or not, but usually merely state the length of the staple in a fraction of an inch with an opinion as to the counts which the sample is suitable for spinning up to. Then follows the estimated value of the cotton in pence. This value is always based on the then ruling price of F. G. F. Middling American whereas it would be much more accurate and of much more value if this were given in percentages taking F. G. F. Middling American as 100. To anyone who has made a study of cotton with a view to improving it, such information is valueless. He is quite able to ascertain this information for himself. He can see for himself what the colour is, whether it is "white" or "creamy-white," whether it is bright or dull or stained. He does not want to know whether it contains leaf or not. He can see this for himself before he sends the sample for report, and if it does contain leaf or broken

seed, it is immaterial as far as he is concerned. Usually leaf is a question of the season and method of picking. The report merely gives information which says either you have had a good or a bad season or else that you ought to insist on more careful picking. He is in a much better position than Lancashire to state what is the length of staple, because he sees it in the *kapas* and can therefore state much more definitely what is the variation in its length and whether this is even or uneven. He is in a much better position also to state whether the fibre has a good natural twist or not, because it is almost impossible to test this from a sample of ginned cotton until this has been spun into yarn. The worker in this country does not want an opinion as to what counts a particular sample of cotton *is considered suitable* for spinning up to. He will have his own opinion on this point, which is probably much nearer the mark. What he does want *are actual spinning tests* which will give him information on this point. These are very difficult to obtain, because it is very seldom the case that mills will take the trouble to make them, and if they do take the trouble to make them and find the cotton is suitable for spinning higher counts than they considered possible, they naturally wish to keep this information to themselves, because it means that they pay less for the raw material.

Then, again, Lancashire is used to quite a different class of cotton to that which is indigenous to India. The bulk of the cotton used there is of the American Upland type which is quite a different class. The individual fibre is very much finer and much weaker. It is quite possible, therefore, that Indian cotton of a shorter staple is capable of spinning as high a count as American Upland provided the staple is even and the natural twist of the fibre is good. Some years ago (1907-08) samples of Indian cotton were sent to Liverpool for valuation to the British Cotton Growing Association. After a considerable time, a letter of apology was received from them stating that they were sorry for the delay. They wrote as follows:—
“ We have approached several brokers in Liverpool and not one of them would take the matter up, as you know Indian cotton is very little used now in this country and consequently there are very few men who understand it.”

On a later occasion samples of cotton, grown from selections of the local Indian cotton, were shown by me to an experienced buyer for his opinion on the spinning value. He stated his opinion that these could be used for spinning up to 26s. As great care had been taken to select these for evenness of staple and also for natural twist in the fibre, I asked him to arrange for spinning tests to be made to find what these cottons would spin up to. This he kindly arranged to do, and although the length of the staple was only $7/8$ " to 1" these spun a useful 40s yarn. A 50s yarn was spun from one sample which was reported to give splendid results. Another selection was found suitable for spinning 44s yarn.

It is quite possible, therefore, that if, and when, Lancashire knows more about Indian cottons, she may wish to qualify her opinion quoted above, somewhat as follows. With the type and class of cotton which I am using at present, I require a staple of—?—inches in length.

If this is so, then it puts a different aspect on the Cotton Committee's considered opinion. Much has been done in recent years to improve Indian cottons and the information as to where such improved cottons are grown and are available can, without difficulty, be ascertained by Indian mills and doubtless they have procured their supplies of raw materials from such sources. I consider, however, that the Cotton Committee have not gone far enough in their statement. They have stated that for 34s twist and 44s weft a staple of 1" to $1\frac{1}{8}$ " is required. Is this so? It may be the experience of the mills because they buy on "type," "class" and "style," and to obtain type, class and style the buyer has to mix. Thus, much of the improvement made in Indian cottons is lost in this process of matching samples. Further, the cotton dealer who supplies cotton to the buyer has imitated the buyer in this process of mixing, but without his knowledge of what the mills require; and this has become so great an evil that the buyer is often in despair in making up his types. Another reason why the length of the staple given by the Cotton Committee is so high is that hardly any mills in India are prepared to pay for quality. The difference in the price of good and bad cotton of the same

kind barely does more than pay for the blow-room and cardroom loss and, as long as this is the case, it does not pay the buyer to supply high grade cotton. It pays much better to mix this with an inferior quality cotton even of the same variety and grade it up. My experience is that the only person who pays for quality is the village dealer and his main object in doing so is to grade up an inferior quality of *kapas* by mixing. The persons who ultimately suffer are the grower and the mill-owner. The grower because a continuance of this process lowers generally the value of the cotton of the tract, and the mill-owner because it limits the fineness of the yarn which he can spin and makes it impossible for him to produce a uniform standard of yarn. The profit goes into the hands of the middlemen.

My reason for writing this is not to proclaim the work which has been done in the past to improve the Indian cotton but to suggest that much greater use might be made of Indian cotton than is the case at present. Very large sums of money are wasted annually, because the capabilities of Indian cotton are not fully appreciated. This tells not only on the prosperity of Indian mills, but also on the prosperity of the grower. Much more careful testing of cotton is necessary in mills and much more detailed reports are required on samples of improved strains submitted for report.

It is not so many years ago that Lancashire discovered that by different treatment American Upland cotton could largely replace Egyptian cotton, but she only discovered this because the necessity for supplementing Egyptian cotton was forced upon her. Is it not possible that in some such way Indian cotton in part can be made to replace American Upland? If so, then Lancashire's difficulty will to some extent be solved. Is, however, the statement quoted at the commencement of this note the right way to set about it?

THE "TAMBERA" DISEASE OF POTATO.*

BY

HAROLD H. MANN, D. Sc.,
Offg. Director of Agriculture, Bombay ;

S. D. NAGPURKAR, B. Ag.,
Of the Union Agency, Bombay ;

AND

G. S. KULKARNI, L. Ag.,
Offg. Assistant Professor of Mycology, Agricultural College, Poona.

IN the Poona district, where the potato crop is a more important one than in any other part of Western India, the plants grown during the rainy season (the *kharij* crop) are severely affected by a peculiar disease, which, on account of the reddish colour which the affected fields acquire, has been termed *tambera* by the potato cultivators. The disease only attacks the *kharij* crop to any serious extent, but of this it is by far the most serious enemy, and, in a year where it is specially prevalent, it often means that the crop of potatoes is so small that the quantity of seed used is barely recovered. It prominently attracted our attention in 1917, and it has been under examination ever since.

The disease attacks the plants in the following manner. At any stage of the plant's growth, but generally after it is a month old, spots with a very slight, somewhat oily-looking, blackish colour begin to appear on the underside of the leaves, and especially

* A paper read at the Seventh Indian Science Congress, Nagpur, 1920.



Fig. 1. Typical attack of *Tambera* disease.



Fig. 2. Typical attack of *Tambera* disease.

on the younger foliage. These spots turn reddish, extend in area and in number very rapidly, and ultimately become a bronze colour, giving an almost uniformly reddish tinge to the leaves. The upper foliage of the plant acquires a bunched-up appearance, the edge of the leaves becomes wrinkled and the leaf hairs become very prominent. Gradually, commencing from the top, the whole of the foliage withers leaving however the main stock still green and living, though it also ultimately becomes discoloured and withers (Plate XV, figs. 1 and 2). The plant endeavours to recover, by giving out a series of auxiliary shoots, which are, however, rapidly attacked and wither accordingly. All these stages only require from thirteen to fifteen days from the beginning to the final ruin of the plants. The attack usually occurs after the tubers are formed and when they are about the size of a walnut. They cease, however, to develop further and hence the yield consists of a very small weight of very small potatoes.

At first a few single plants are attacked, but from these the disease spreads in patches until the whole fields are affected. This spread is very rapid. As an example, a patch of potatoes which was carefully watched in 1919 may be described. The whole patch of potatoes was thirty-three feet square. On the first day only four plants could be detected with the disease, three near one corner and another nearer the centre of the field. Five days later, the whole of the corner of the field round the former plants and a large circular patch round the latter were obviously attacked. Three days after, the whole field was affected except a narrow strip down the middle, while on the thirteenth day from the commencement, the field was red and withering from end to end. The disease comes on almost as if a fire is passing through the fields and is universally attributed by the cultivators to the prevalence of light, misty rain which often occurs during the months of August and September.

It is obvious that a disease like this is of very great importance, and it indeed appears to be the factor which limits the spread of the cultivation of potatoes during the *kharif* season in Western India. It has now been found not to be limited to the Poona potato area, but also occurs in other districts and even in Sind.

It has been noticed in the *rabi* (winter) crop also, but there it never does any serious harm and it may be almost ignored.

All attempts to trace the immediate cause of the disease for a long time proved futile. Fungus diseases were absent, and no trace of a bacterial affection could be found. Everything indicated that the attack was due to a parasitic attack of some sort, but it was not until 1919 that the nature of the parasite was discovered. At that time our attention was drawn to a disease which appeared to be of a very similar kind reported from Hawaii in 1917¹ and which was attributed to the work of a mite. The appearance shown in the illustrations of the disease seems to agree very closely with that shown in *tambora* and hence a careful search was at once made for the very minute mites described. We had already been able to produce the disease at will by growing the potato plants under conditions of high temperature, and on examination they were found to be swarming with mites exactly similar in character to those found in Hawaii.

These mites are found on all the affected parts, especially on the under-surface of the leaves of the plants. They are so small as to escape notice with the naked eye, until the eye is trained how to look for them, and even with a hand lens unless carefully looked into. They can, however, be easily seen in all stages under the microscope with a low power. The eggs are peculiar sculptured bodies rounded oval in shape, and firmly attached to the leaf. The egg cases, even after the emergence of the larvæ, persist for a long time as colourless, transparent objects, still retaining the sculpturing in the form of rows of small opaque white globules. The young mites are hyaline, have three pairs of legs and are sluggish. The moult and the skins thrown off by them are seen in great numbers, as white specks. The adult female is a clear amber colour, with smooth glistening skin, and has a fourth pair of legs which are much thinner than the remaining ones. It is an oval active creature moving about on six legs while the other two are dragged behind, and measures one-fifth by one-tenth millimeter. The male is of the

¹ Carpenter, C. W. "A new disease of the Irish potato." *Phyto-Pathology*, Vol. VIII, p. 286 (1918).

same colour with a brownish tinge, but is quite different in size and shape. It is more orbicular and smaller, measuring one-tenth by one-eleventh millimeter, with a clouded dorsal spot, and it possesses strongly developed legs and is much more active than the female. The first pair of legs has two joints, the second and third pairs have five joints and the fourth pair has four joints and each joint bears a few hairs.

The mites apparently suck up the juice from the epidermal cells of the leaves with the result that the leaves are unable to stand the heavy drain on them and wither prematurely. The mites then leave such leaves and go in search of fresh leaves which they easily reach by crawling over from plant to plant as the plants touch one another. Whether they are, like some other mites, carried by insects or other agencies is not known.

The naming of the mites is the work of a specialist. Carpenter does not attempt it. He makes a formal statement that they may belong to the same group as the so-called red-spider (*Tetranychidæ*).

The mere presence of the mite is not, of course, sufficient to enable us to attribute *tambera* disease to it unless the connection is proved by actual inoculation experiments. Carpenter in his paper does not record any experimental evidence, but bases his conclusions on the mere presence of the mites. He states as follows:— "That these minutest organisms are responsible for the disease seems evident. They are present in sufficient numbers on the plants with the recognized symptoms to warrant this conclusion and the reaction of the plant is such as we have come to associate with mite injury. Furthermore, if the mites be kept off a portion of the plants by spraying or dusting with sulphur those so protected develop normally while adjacent unprotected plants are devastated."

The following inoculation experiments were, however, carried out. At first only two plants in pots were brought into the laboratory and on being convinced that they were quite free from the mite attack one was used for inoculation and the other as control. Inoculation was made by putting on the plant to be inoculated affected shoots from a diseased plant containing mites. The inoculated

plant began to show the symptoms on the third day. On the fifth day these were quite clear and on the eighth day the withering of leaves commenced (Plate XVI, fig. 1). The control plant kept away from the inoculated one did not show any of the symptoms and remained quite healthy (Plate XVI, fig. 2). Encouraged with this trial, experiments were made on a greater number of plants. Ten plants were raised in pots. Five were used for inoculation and five for control. Inoculation of the plant was done as before on the 5th of August, 1919, by placing on them the affected shoots containing mites. The plants began to show the disease on the next day, and on the fourth day the symptoms were quite evident, namely, the bunching of shoots and the browning of the under-surface of tender leaves. At this stage the examination of a browned leaf under the microscope showed any number of moving mites with their eggs. On the eighth day the shoots were completely bunched up and were much darkened in colour. In one plant leaves were withering. Thirteen days later, most of the top leaves of all plants were quite reduced in size and dried up. The controls remained quite healthy during this period. The results of the experiments conducted, in the same way, in the fields too were quite conclusive. Leaves affected and covered with mites were attached to a few plants in a corner of a plot where there was no disease and the plants were kept under observation. The inoculated plants alone took the disease and the attack started from the point of contact with the affected leaves. The mites were again found in intimate association with the disease on the new plants.

The casual connection of the mites with the disease at once suggested a method of control, by spraying with a sulphur wash, or by dusting with sulphur, and preliminary trials were made in pots where the potatoes were seriously affected. Both methods proved effective, and it was found possible to revive plants which were in a very advanced stage of the disease. Experiments on small plots proved equally effective.

The potato crop is so valuable that the application of such a spraying method as a safeguard against the disease would pay well, and hence a limited area in the fields of the cultivators has been



Fig. 1. Plants inoculated with *Tamera* mite.



Fig. 2. (1) Plant inoculated with *Tamera*; (2) Control plant without inoculation.

sprayed with lime sulphur wash, or dusted with sulphur, during the past season, three dressings being given commencing from the time when the plants were three weeks old. The results were excellent and a demand at once arose from the people to spray their whole area. The season and the disease had, however, by that time advanced so far that it was impossible to do anything this year. Spraying with lime sulphur wash, however, was a little more effective than dusting with sulphur. Three treatments were given—the first when the plants were three weeks old, the second when about six weeks, and the third when they were between two and three months from planting. The difference between the yield of the sprayed fields and those unsprayed in the immediate neighbourhood in 1919 was very great. The yield of the unsprayed plot was only 1,000 lb. per acre, or practically the amount of seed used; that of a plot sprayed after the attack commenced was 5,000 lb. per acre; that of a plot sprayed from the beginning was 8,720 lb. per acre. The cost of the complete spraying treatment this year was Rs. 13 per acre, but this can be materially reduced. At present, spraying, though more effective, is a new process to the cultivators, and it is probable that dusting with sulphur from muslin bags will be more generally used.

An attempt has been made to see if any of the varieties available are immune to the disease. All those commonly cultivated are, however, rapidly attacked if conditions are favourable. An English variety, "Epicure," in experimental trials seemed to possess some resisting power, but further experiments are necessary with it. The favourite variety in Poona, a round, white, Italian type, known in Western India as "Talegaon," was the first to be attacked, and the other local varieties soon followed.

It is difficult to say how the mites which cause the disease are carried over from year to year. Looking to the field conditions of the tract where these observations have been made, it appears that the disease may possibly be carried over on the potato plant itself. Although there are two definite seasonal crops, the *kharij* and the *rabi*, with regular intervals, the seasons are not sharply defined and potato cultivation goes on practically uninterruptedly between

June and March. The *kharif* crop is sown in June and July and is harvested in September and October, sometimes even in November. The sowing of the *rabi* crop begins in November and extends even up to March, the harvesting of very late planted crops coinciding with the planting of the *kharif* crop again. Stray plants arising from the remnant tubers of the previous crop are also found in the fields. It is thus seen that the potato plants are found throughout the year in the tract either as a regular crop or as stray plants, and the *rabi* crop though not seriously attacked is not by any means free from the mite. Owing to the cold weather the disease never does much damage and hence does not attract attention. The mite, however, comes into activity again as soon as the hot weather sets in in April and May. From the hot weather crop it is probably carried to the *kharif* season again.

Another possibility, of course, is that the mite may have other host plants. So far we have found what appears to be the same mite on *guvar* (*Cyamopsis psoraloides*) only. On this plant it has been recorded from Baroda, Padra, Surat, and Poona. Cross-inoculations have proved that the *guvar* mite and the potato mite are one and the same. Potato plants when infected with the *guvar* mite easily took the disease. Chilli and tomato plants were also tried, but they remained free from the disease. More observations and experiments are required on this point.

THE BIOLOGICAL ASPECTS OF WHEAT CULTIVATION ON EMBANKED SOILS.*

BY

F. J. PLYMEN, A.C.G.I.,

Department of Agriculture, Central Provinces ;

AND

D. V. BAL, L.Ag.,

Bacteriological Assistant, Department of Agriculture, Central Provinces.

I. INTRODUCTION.

A PECULIAR TYPE of *rabi* cultivation for wheat is carried on in the Haveli tract in the north of the Central Provinces. The system has been fully described by Mr. Evans¹ when Deputy Director of Agriculture, Northern Circle, Central Provinces, so a detailed description of the agricultural practice is unnecessary. It may, however, be stated that the usual *rabi* crops—wheat, gram, *teora* (*Lathyrus sativus*), *masur* (*Lens esculenta*), linseed, etc., either pure or in mixture—are grown in a soil which for the greater part of the monsoon months is water-logged. Banks or *bunds* are erected on any level fields and the monsoon rainfall is impounded. The average rainfall in the tract is 50–60 inches. During the hot weather one single cultivation may or may not be given. The fields are allowed to be flooded, and in the month of October the water is run off. As the field dries, seed is sown with a plough (*nari*) and here again a preliminary cultivation may or may not be given. The

* Paper read at the Seventh Indian Science Congress,, Nagpur, 1920.

¹ *Agri. Journal of India*, Vol. VIII, 1913, p. 117.

average out-turn is about 700 lb. per acre of either wheat, gram, or *masur*. This brief outline of the system followed in this tract will show that the soil undergoes three distinct phases. There is the dry hot weather season when the soil frequently cracks to considerable depths. This is followed by a period when the soil is submerged by the monsoon rainfall and again by a growing season when the percentage of moisture in the soil gradually falls from full saturation to the hot weather state. It should be explained that the soil in itself is a particularly heavy one containing, as will be seen from the figures quoted in Table I, nearly 75 per cent. of clay and silt.

Our attention was drawn to these soils by Mr. G. Evans, Deputy Director of Agriculture, Northern Circle, Central Provinces, and by one of the leading landholders. It was stated that these soils are found to be gradually decreasing in fertility but the peculiarities of the agricultural practice followed, seemed to call for an examination of the bacteriological processes prevailing in the soil. It was also pointed out that the early growth of the wheat plant, by its dwarfed and yellow colour, indicated nitrogen starvation. It will be observed that no manure is applied to this land and the soil depends for its crop-producing power on natural recuperative processes for maintaining soil fertility.

It was further considered that saturation with water during most of the rainy season might possibly tend to diminish the power of the soil to render available the nitrogen contained in it.

II. EXPERIMENTAL.

Experimental plots were laid out in the year 1915-16 on land in the Haveli tract at Kheri near Jubbulpore. Three fields were chosen and cultivated as follows:—

Plot I was not surrounded by a *bund* or embankment and was ploughed in the beginning of the monsoon and harrowed at intervals during the monsoon.

Plot VI was kept flooded until one month before sowing time, when the water was drained off and one harrowing given before sowing.

Plot VII followed the usual practice. It was kept flooded as long as possible and not cultivated at all.

The three plots therefore represent the maximum aeration possible, partial aeration and no aeration.

The following analyses will show that mechanically the soils in the various plots were very similar.

TABLE I

Showing the physical analyses of the soil from the various experimental plots.

	Plot I	Plot VI	Plot VII
Clay	44.10	45.90	45.000
Fine silt	15.40	14.30	14.800
Silt	14.00	12.70	13.300
Fine sand	10.80	8.90	8.300
Coarse sand	2.80	5.70	4.100
Moisture	7.70	7.00	7.200
Loss on ignition	5.56	5.73	6.940
CaCO ₃	0.10	0.14	0.115
TOTAL	100.46	100.37	99.755

The analyses indicate that the soil is a heavy sticky clay. It is black in colour and needs to be cultivated at the proper time or the tilth is destroyed. The maximum saturation capacity, as determined by Hilgard's method, with a soil layer 1 c.m. deep, is about 60 per cent. by weight.

In the first year definite biological work was not possible, but samples of soil were taken at intervals between the beginning of the monsoon and harvest time and determinations of nitrogen as ammonia, nitrogen as nitrates, total organic nitrogen, humus, moisture and calcium carbonate were made.

A résumé of the results is given in Table II (p. 296).

The remarkable feature about these results is the small proportion of easily available nitrogen present in these soils. Further, the stock of nitrogen present in the soil to be drawn on for the future use of the plant is very small. This fact suggested that possibly the nutrition of the wheat plant on embanked land is very closely connected with seasonal bacterial activity in the soil and does not

depend to any great extent upon accumulated plant food stored up in reserve.

During the next season arrangements for bacteriological work were possible, hence a study of the bacterial activity in these soils was taken up. The usual biological analyses of the soils dealing with nitrogen fixation, ammonification, and nitrification, etc., were first carried out and some interesting results were obtained which can be summarized as follows :—

- (1) The soils under experiment appear to be very energetic in nitrogen fixation, that is, they are able, to a more than common extent, to take up nitrogen from the air by bacterial processes.
- (2) Having taken up this nitrogen, they have considerable ammonifying power, that is, they are able rapidly to break down organic nitrogen to the simpler form of ammonia.
- (3) In the conversion of ammonia into nitrate, these soils appear to be distinctly weak, the oxidation only going as far as the nitrite stage, very little nitrate being formed. The figures obtained are tabulated in Table III at p. 297.

Having found from the previous year's results that these soils are of low nitrifying power, experiments were continued during the next year with certain additions. In the first place, a series of moisture determinations were made in order to see to what extent the various methods of treatment modified the water content of the soil. The first determination was made in October after heavy rains, and Plots I, VI, VII contained 35, 40, and 44 per cent. of water, respectively. This showed a considerable difference between the embanked plots but by the 10th November the figures had decreased to percentages of 23, 23, and 29 for the same plots. Further determinations were made in January in the middle of the growing season and the water content of all the plots was uniform at 17 per cent. These figures (Table IV) indicate that in a year of good rainfall an unembanked field is as good as an embanked one, as the soil can only hold a certain amount of water and the impounded water

upon the surface does not materially affect its water content at the important time of the season, that is, from November to February. If the rains stopped early, the moisture conditions of the various plots might be different. Apparently, about 20 to 25 per cent. of moisture is what the soil wants at sowing time.

It may be concluded that in a year of good rainfall no advantage accrues from embankments as regards the water content of the soil, but as no year of low rainfall has occurred during the course of the experiments, the authors are unable to give data for a very abnormal year.

In making observations of the power of the soil for nitrifying ammonium sulphate in Omeliansky's solution, it was noticed that nitrification progressed quickly at a temperature of 30°C., but at the lower air temperature prevailing during the cold weather, nitrification was very slow although it proceeded as far as the nitrite stage (Table III).

In soil medium, with oil cake as material to be nitrified, the same effect was noticed.

In this case, however, it was found that ammonification proceeded rapidly, about 33 per cent. of the organic nitrogen added being ammonified in a period of 15 days. The deficiency in nitrate forming power was not improved by the addition of reasonable quantities of calcium carbonate or copper sulphate¹ (Table V).

In all cases, only about 3 to 5 per cent. of organic nitrogen added to the soil was converted to nitrate within a period of 8 weeks.

The black cotton soil of the Deccan is of somewhat similar texture to the soils under experiment but is given an open cultivation and experiences a lower rainfall. From the figures quoted in Table V it will be seen that the nitrifying power of black cotton soil is very superior to that of Kheri soil even under similar conditions regarding water content, temperature, etc.

Incubation of the soil with the cake at 30-33°C. increased, however, the nitrifying efficiency to a very great extent, though it was much below the ordinary nitrifying capacity of black cotton

¹ Lipman and Burgess. *Univ. Cal. Pub. Agri. Sci.*, Vol. I, No. 6, pp. 127-139.

soil under similar conditions (Table VI). The maximum amount of nitrogen converted into the form of nitrate, within a period of 8 weeks, was only 50 per cent. in the case of Kheri soils as against 85 per cent. in the case of black cotton soil. Water content to the extent of 25 to 30 per cent. seems to be the optimum for nitrification for these soils (Table VII).

The wheat growing area in the north of the Central Provinces extends from Jubbulpore down to Hoshangabad, the whole area being known as the Narbada Valley. In Jubbulpore district the system of embankment is common, but it is not practised in Hoshangabad. In the latter district, the wheat soils are given good open cultivation. The rainfall of the two districts and the soils are not very dissimilar. It is also considered that varieties of wheat grown in Hoshangabad do not suit the conditions prevailing in Jubbulpore Haveli and *vice versâ*.

On determining the nitrifying power of Hoshangabad soil, it was found that it was very superior in this respect to Kheri soil (Table VI). The authors were, therefore, led to investigate the question whether by reason of the small amount of nitrate available in embanked land, wheats grown under such conditions were forced to take in their nitrogen in a form other than nitrate. Pot experiments were conducted at Nagpur in which Hoshangabad wheats were grown on their own soil and on soil from an embanked area, and Jubbulpore wheats on their particular soil and on soil from the open cultivation at Hoshangabad. At the same time the plants were manured with nitrogen either as nitrate or ammonia. Unfortunately with these heavy clay soils it was found almost impossible to obtain good conditions for growth in pot experiments and the results were not very convincing. It was, however, noticeable that nitrogen as ammonia on soils from the embanked tract had a greater manurial effect than the same amount of nitrogen as nitrate. This was more marked with Kheri soils and Jubbulpore wheats than with Hoshangabad and Nagpur soils. The Jubbulpore wheats showed a marked preference for ammoniacal nitrogen particularly on Kheri soil but the Hoshangabad wheats did not evince such a definite partiality.

For the past two years, attention has been particularly paid to the changes which the soil may be undergoing in its nitrifying capacity, and the results will be found in Table VIII. It will be noticed that Plots I and VI show a nitrifying power greater than that of Plot VII, and apparently this nitrifying power is increasing. The results for the years 1917-19 bring out an interesting point indicating the intimate connection between laboratory experiments and field conditions. A bad tilth was obtained in that period and this exerted a depressing effect on both the nitrifying power and the yield of crop.

It was generally observed during the 4 years of experiment that the young plants in Plots I and VI did not show the yellow colour generally attributed to nitrogen starvation.

III. SUMMARY.

1. It was brought to the notice of the Agricultural Chemist, Central Provinces, that the embanked wheat soils of Jubbulpore tract were said to be gradually deteriorating and giving low yields.

2. It was observed that wheat plants in such embanked fields appear weak and yellow in the early stage of their growth, but recover later on.

3. Mechanical analyses of the soil were carried out. The soil is heavy and sticky black in colour but less so than ordinary black cotton soil. It gets very hard and forms tenacious blocks on drying after rains.

4. Biological analysis shows that these soils possess very good power for ammonification and nitrogen fixation, etc., but are rather slow at nitrification.

5. The nitrifying power of the soil increases gradually when rainy weather cultivation is given to the soil.

6. The out-turn of wheat is also considerably increased when some form of rainy weather cultivation is given to embanked wheat soils and wheat seedlings from plots receiving cultivation do not appear yellow and weak in the early stage of their growth.

7. From the experimental results obtained it appears that young wheat plants in embanked fields are subject to some factor which retards their growth. This factor may be due to lack of

available nitrogen or the presence of some deleterious substance formed under anaerobic conditions. It is evident that whatever the cause it is removed by cultivation and aeration during the monsoon months.

8. Experiments with a more precise control over field trials are in progress with a view to determining the most economic form of cultivation. Attention will also be given to determine, if possible, the exact factor which interferes with the growth of young wheat seedlings on embanked soils.

9. Experience gained from this enquiry shows the difficulty of using pot cultures in very heavy soils such as that under experiment. It is impossible to reproduce field conditions in pots when the soil has to be transferred from field to pot culture house.

TABLE II

Showing the amounts of nitrogen as ammonia, nitrate, etc., in various plots.

Plots and samples	Nitrogen as ammonia	Nitrogen as nitrate	Total available nitrogen	Moisture	Carbonate of lime	Humus	Nitrogen
Plot I							
Sample A ..	0.00035	0.00020	0.00055	..	0.12	0.85	0.03
do. B ..	0.00015	0.00066	0.00081	15.34
do. C ..	0.00023	0.00021	0.00044	13.66
Plot VI							
Sample A ..	0.00045	0.00005	0.00050	..	0.14	0.94	0.03
do. B ..	0.00010	0.00053	0.00063	14.33
do. C ..	0.00024	0.00021	0.00045	14.82
Plot VII							
Sample A ..	0.00055	0.00023	0.00078	..	0.11	0.96	0.03
do. B ..	0.00005	0.00045	0.00050	15.67
do. C ..	0.00026	0.00031	0.00057	13.88

TABLE III

Showing nitrification of ammonium sulphate in Omeliansky's solution in mgm. at different temperatures. (100 c.c. dilute solution containing 10.6 mgm. nitrogen was employed.)

	LOWER TEMPERATURE OF THE ROOM						AT 30°C.					
	Plot I		Plot VI		Plot VII		Plot I		Plot VI		Plot VII	
	Nitrite	Nitrate	Nitrite	Nitrate	Nitrite	Nitrate	Nitrite	Nitrate	Nitrite	Nitrate	Nitrite	Nitrate
1st week	5.10	..	traces	..	traces	..	3.85	..	1.78	..	1.49	..
2nd week	1.43	1.43	1.43	..	1.36	..	8.90	..	8.00	..	8.00	..
3rd week	3.57	3.71	3.71	..	3.57	..	9.60	0.85	9.20	..	9.20	..
4th week	8.21	8.21	8.21	..	8.90	8.54	..	6.40	..	6.83
5th week	9.90	..	8.50	..	7.82	9.40	..	7.68	..	8.11
6th week	9.90	0.34	10.70	0.26	11.40	0.26

TABLE IV

Showing percentages of moisture in the various Kheri plots in various years.

	YEAR 1915-16		YEAR 1916-17			YEAR 1917-18	YEAR 1918-19	REMARKS
	Date of sampling		Date of sampling			Date of sampling	Date of sampling	
	31-10-15	1-1-16	20-10-16	10-11-16	26- 1-17	20-10-17	30-10-18	
Plot I	15.34	13.66	34.6	22.9	16.60	25.6	16.9	In the year 1918-19 the samples were taken late owing to unavoidable reasons. Due to absence of late rains sowing was done rather earlier. The plots however received sufficient rain just in the right time when the plants were about 6 inches high.
Plot VI	14.33	14.82	39.7	22.6	17.20	30.9	14.6	
Plot VII	15.67	13.88	43.9	28.9	16.60	31.6	20.0	

TABLE V

Showing nitrification of cake in Kheri and black cotton soil at lower temperature with and without addition of substances like chalk, copper sulphate, etc. (Cake supplied at the rate of 60 mgm. per 100 gm. of the dry soil.)

	SOIL AND CAKE							SOIL + CAKE + CALCIUM CARBONATE 1 %							SOIL + CAKE + COPPER SULPHATE 1 %							SOIL + CAKE				
	Plot I		Plot VI		Plot VII		Plot I		Plot VI		Plot VII		Plot I		Plot VI		Plot VII		Plot I		Plot VI		Plot VII		Black cotton soil	
	% N as NH ₃	Total % N as nitrified	% N as NH ₃	Total % N as nitrified	% N as NH ₃	Total % N as nitrified	% N as NH ₃	Total % N as nitrified	% N as NH ₃	Total % N as nitrified	% N as NH ₃	Total % N as nitrified	% N as NH ₃	Total % N as nitrified	% N as NH ₃	Total % N as nitrified	% N as NH ₃	Total % N as nitrified	% N as NH ₃	Total % N as nitrified	% N as NH ₃	Total % N as nitrified	% N as NH ₃	Total % N as nitrified	% N as NH ₃	Total % N as nitrified
2 weeks ..	31.10	—	23.20	—	26.00	—	33.60	—	24.2	—	28.00	—	23.2	—	23.2	—	18.60	—	23.2	—	23.2	—	23.2	—	29.74	2.12
4 weeks ..	32.53	—	31.10	—	27.89	—	32.60	traces	33.6	—	32.60	—	31.1	—	31.1	—	25.10	—	31.1	—	28.0	—	28.0	—	12.08	54.03
6 weeks ..	31.64	5.230	30.71	—	32.53	—	15.12	5.4	16.8	—	18.72	—	27.0	—	27.0	—	30.71	—	27.0	—	33.6	—	33.6	—	0.93	76.74
8 weeks ..	24.17	0.801	25.10	2.54	31.64	traces	22.40	11.2	25.1	6.5	26.13	traces	26.3	—	26.3	—	24.20	—	26.3	—	28.9	—	28.9	—	1.86	82.96

TABLE VI

Showing nitrification of cake in Kheri black cotton and Hoshangabad soils incubated at 30°C. (Cake = 60 mgm. nitrogen per 100 gm. dry soil employed.)

	Plot I		Plot VI		Plot VII		Black cotton soil		Hoshangabad soil	
	% N as NH ₃	Total % N nitrified	% N as NH ₃	Total % N nitrified	% N as NH ₃	Total % N nitrified	% N as NH ₃	Total % N nitrified	% N as NH ₃	Total % N nitrified
2nd week ..	41.0	—	38.2	traces	39.2	traces	18.6	54.0	40	13.68
4th week ..	28.0	21.0	28.0	17.8	31.1	10.8	3.7	81.3	—	31.00
6th week ..	23.2	26.7	23.2	21.5	15.8	23.5	2.8	76.8	—	64.00
8th week ..	16.8	42.8	14.8	42.8	9.3	46.9	0.9	85.4	—	76.80

TABLE VII

Showing nitrification in Kheri soil Plot I at different saturations at 30°C. (Cake = 60 mgm. nitrogen per 100 gm. dry soil employed.)

	1/3 SATURATION = 20 % MOISTURE		3/8 SATURATION = 22.5 % MOISTURE		1/2 SATURATION = 30 % MOISTURE	
	% N as NH ₃	Total % N nitrified	% N as NH ₃	Total % N nitrified	% N as NH ₃	Total % N nitrified
2 weeks ..	33.60	0.41	34.39	0.41	36.25	0.53
4 weeks ..	37.18	1.20	34.39	7.08	26.13	20.26
6 weeks ..	41.00	4.56	30.71	14.39	22.40	27.72
8 weeks ..	38.31	8.26	25.10	29.88	13.01	51.09

TABLE VIII

Showing the rate of nitrification in different plots in different years in sampled soil with 60 mgm. nitrogen as cake and optimum moisture content. (Soils were incubated at 30°-33°C. Amount of nitrogen nitrified is represented in terms of percentages and includes both nitrite and nitrate nitrogen found.)

	1915-1916			1916-1917			1917-1918			1918-1919			REMARKS
	Plot I	Plot VI	Plot VII	Plot I	Plot VI	Plot VII	Plot I	Plot VI	Plot VII	Plot I	Plot VI	Plot VII	
After 2 weeks	Nil	Nil	Nil	traces	traces	traces	2.66	7.40	6.60	3.4	1.3	1.4	In the year 1917-18 the texture of Plot I was spoilt due to untimely cultivation resulting in the formation of very hard clods and that in Plots VI and VII was also not quite good.
„ 4 weeks	9.8	2.5	2.5	21.0	17.8	10.8	5.32	10.66	8.53	13.0	8.9	7.7	
„ 6 weeks	15.5	14.8	13.8	26.7	21.5	23.5	6.40	19.20	14.92	27.7	21.6	17.7	
„ 8 weeks	25.6	27.6	21.3	42.8	42.8	46.0	15.96	29.84	21.32	38.4	42.7	29.9	

TABLE IX

Showing average out-turn of wheat grain per acre in lb.

Plot I	683
Plot VI	679
Plot VII	562

Selected Articles

THE FUTURE OF WHEAT PRODUCTION WITH SPECIAL REFERENCE TO THE EMPIRE.*

IN view of the importance of the question of the future of wheat production, the present article has been prepared by Mr. A. S. Judge, lately Chief Collector of Customs, Burma, from published information and material available at the Imperial Institute.

WHEAT IN RELATION TO OTHER CEREALS.

In dealing with the question of the consumption and disposal of the wheat crops of the world, it is essential that those of other cereals should be taken into consideration, for in times of shortage these grains are substituted for wheat, and some of them provide the staple food of the inhabitants of various parts of the world.

World's production of cereals.

Wheat and rice are the two principal cereals which provide food for mankind ; millets, rye, maize, barley, and oats, especially the first three, are used as human food in many countries, but are more generally used in Western countries for feeding live-stock. The annual production of wheat in the world amounts to about 110,000,000 tons, while that of rice, assuming that the out-turn in China is equal to that of India, is about 90,000,000 tons. Rice is the staple food of the majority of the inhabitants of India, China, Siam, Japan, Korea, Formosa, the Philippine Islands, Ceylon, and the Malay Peninsula and Archipelago ; it may be estimated that more than one-third of the human race are rice-eaters. Wheat is the principal bread grain of the Western nations, and the world's production of this grain is almost entirely converted into flour, in the course of which process various by-products are obtained.

* Reprinted from the *Bulletin of the Imperial Institute*, Vol. XVII, No. 2.

which are used as cattle food. Wheat provides food for the majority of the inhabitants of Europe, America, Australasia, Northern Africa, and of those parts of Asia where rice is not the staple food.

In Northern and Central Europe, black bread made from rye takes the place of wheaten bread among the poorer classes. The estimated production of rye in the world is about 45,000,000 tons, of which more than one-half is raised in Russia, and one-fourth in Germany. Rye is also grown in the United States, and during the war Scandinavian countries obtained their requirements of rye and rye flour largely from this source.

There is an increasing demand for wheaten flour throughout the world; it has been replacing rye in Europe, and in Germany the average consumption of wheat per capita advanced from 130 lb. for the ten years ending 1889 to 190 lb. for the ten years ending 1912; in Asia, Africa, and South America also natives prefer wheaten flour to their ordinary diet, and the demand for this flour will advance as the material prosperity of the people improves. It is fortunate, therefore, that vast tracts of virgin land are available for wheat-growing in Canada, Argentina, Australia, and Siberia, and that the old-world granary of Mesopotamia, after centuries of neglect and misrule, will again provide abundant supplies of food for mankind. The rice-lands in Eastern countries with their teeming populations have, on the other hand, nearly all been brought into cultivation, and although lands suitable for rice are available in Africa and America, it seems doubtful whether rice will be cultivated on an extensive scale in these countries.

The quantity of maize produced in the world is probably greater than that of wheat, and the demand for this grain is constantly increasing. Maize is a prolific crop: it is estimated that it takes a little more than half of the acreage laid down to wheat to provide the same yield of maize. The United States contribute at present about 70 per cent. of the total world's production; Argentina, Brazil, Mexico, Peru, India, Egypt, Russia, Rumania, Hungary, and Italy are also large producers, and British South Africa, with a suitable climate for this crop, promises in the future to supply large quantities of maize. In Europe and North America

maize is chiefly used for feeding live-stock, and the wonderful development of the pork industry of the United States is directly related to the maize crop. In parts of South America, Africa, Asia, and of Southern and Eastern Europe, maize provides food for the people. Although corn-flour is largely eaten in all civilized countries, this flour alone cannot be made into a light porous loaf, as can wheaten flour, owing to the difference in the character of its gluten.

Barley is an important crop in Europe, especially in Russia and Germany; it is also extensively cultivated in North America, Northern Africa, Japan, China, India, and Asiatic Turkey. The annual production in the world cannot be short of 50,000,000 tons. In Europe and North America the grain provides food for cattle, and the best qualities are also largely used by distillers and brewers, the by-products which result forming valuable food for cattle. Barley is eaten, to some extent, by the inhabitants of Northern Africa, and also in parts of Asia; its principal use is, however, as fodder for cattle. During the war, barley meal was used in most of the European countries for admixture with wheaten flour in the manufacture of bread.

The annual production of oats in the world is estimated at about 65,000,000 tons; oats are raised principally in Europe and North America, mainly as food for cattle. An increasing quantity of oatmeal and other preparations of this grain is now being consumed throughout the world; in 1918 the United States exported over 150,000 tons of oatmeal, rolled oats, etc.

Millets are grown extensively in Asia, Africa, and also in Russia, and the Balkan States. It is not possible to frame any reliable estimate of the quantity of this grain produced in the world. In India 52,000,000 acres are devoted to millets, and the supply of human food obtained from this source is only of less importance than rice. In China also there is a large cultivation, and in Japan the estimated out-turn of grain is 500,000 tons. The production in Egypt is 250,000 tons, and millets are grown in many other parts of Africa. The production in Russia in 1912 was about 2,500,000 tons. During the same year Russia produced 1,200,000 tons of buckwheat. France and the United States each produced about

400,000 tons of this grain, which is also grown in other parts of the world.

World's consumption of cereals.

The following statement shows the average consumption per head of population, in certain countries, of wheat, rye, barley, oats, and maize for the five years 1909-13:

Country	Wheat	Rye	Barley	Oats	Maize	Total
	lb.	lb.	lb.	lb.	lb.	lb.
United Kingdom	360	3	115	181	99	758
France	493	64	61	292	59	969
Belgium	505	195	123	204	128	1,155
Netherlands	263	241	113	140	201	958
Denmark	245	500	409	622	238	2,014
Sweden	158	251	114	433	17	973
Russia	180	244	72	155	18	669
Spain	340	66	156	41	98	701
Italy:	370	8	13	37	179	607
Germany	191	323	213	269	27	1,023
Austria	217	213	121	174	73	798
Hungary	310	84	120	105	479	1,098
Rumania	181	3	22	70	481	757
Canada	755	15	226	1,339	211	2,546
United States	319	18	81	349	1,564	2,331
Argentina	354	3	14	28	408	807
Japan	31	—	87	3	4	125
Egypt	191	—	46	—	311	548
Australia	328	—	28	116	125	597

The above statement has been prepared from the Statistical Notes published by the International Institute of Agriculture, Rome. The consumption covers not only human food, but also cereals required for feeding live-stock, and for industrial purposes; seed requirements are, however, excluded.

The consumption of rice in the Western countries of Europe and in America may be estimated at between 8 and 10 lb. per capita; the pre-war average in the United Kingdom was 8 lb., but latterly it has been twice as great. In Italy and Spain, where rice is grown, the consumption is over 25 lb., and in Egypt it is over 50 lb. In Japan, where rice is the staple food of the people, the consumption is about 400 lb. In Italy, Russia, Egypt, and Japan millets and buckwheat are largely consumed.

There are no estimates showing the quantity of cereals required for human consumption in the countries mentioned above. It

may be estimated, however, that the average consumption per capita is 4 cwts. of grain, equivalent to about 300 lb. of flour or meal. The quantity of flour or meal obtained from grain varies according to the quality of the grain; it is, however, generally estimated that 133·3 lb. of wheat or barley, 153·8 lb. of rye, 166·6 lb. of oats, and 117·6 lb. of maize are required to produce 100 lb. of meal or flour. The amount of cereals consumed in different countries varies considerably: in France and Belgium, for instance, the mass of the people eat more bread and farinaceous food than those in England and America, who are accustomed to a more liberal meat diet. More wheaten flour is consumed in France and Belgium than in any other country, the high rate of consumption of wheat in Canada being due to the fact that in the past this grain was often given to cattle. An examination of the statement given above shows that wheat is the principal cereal consumed in the Western countries of Europe, whereas in the Central and Northern countries generally rye is more largely eaten than wheat. In Rumania wheat is extensively grown for export, maize being the chief diet of the people.

Source of European supplies of cereals.

The following table shows the average production of cereals in certain countries of Europe for the five years 1909–13 (1,000 tons):—

Country	Popula- tion	Wheat	Rye	Bar- ley	Oats	Maize	Rice	Millets, buck- wheat, spelt	Total
United Kingdom ..	45,400,000	1,623	20	1,422	2,998	—	—	—	6,063
France ..	40,000,000	8,644	1,245	1,049	5,156	566	—	400	17,060
Belgium ..	7,500,000	405	580	94	618	—	—	—	1,697
Denmark ..	2,800,000	145	451	543	776	—	—	—	1,915
Spain ..	20,000,000	3,550	702	1,626	422	674	350	3	7,327
Italy ..	35,000,000	4,989	135	220	536	2,548	500	130	9,058
Germany ..	65,000,000	4,156	11,325	3,344	8,642	—	—	400	27,867

The average production, surplus of imports over exports, and consumption per capita of cereals in each country for the five years 1909-13 were as follows :

		Average production	Average surplus of imports over exports	Average consumption
		cwts.	cwts.	cwts.
United Kingdom	..	2.6	4.3	6.9
France	8.5	1.1	9.6
Belgium	4.5	6.2	10.7
Denmark	13.7	5.3	19.0
Spain	7.3	4	7.7
Italy	5.1	1.1	6.2
Germany	8.5	1.6	10.1

Continental countries, as a rule, protect their agricultural industries by imposing import duties on cereals. In Germany the import duty on a quarter (8 bushels) of wheat was 11s. 10d. ; in France 12s. 3d. ; and in Italy 13s. The import duties in flour were on a higher scale. Belgium and Denmark admitted wheat free of duty.

The above table shows how dependent this country is on imported grain. With the exception of Norway and Finland, no other country in Europe is so dependent on outside supplies. Denmark, in proportion to her population, imports a greater quantity of grain than the United Kingdom ; this is due, however, to the fact that her live-stock industry is relatively much more highly developed. The following table shows the number of live-stock in the two countries in 1912 :

		Cattle	Sheep	Pigs
		No.	No.	No.
United Kingdom	..	11,914,635	28,967,495	3,992,549
Denmark	2,253,982	726,879	1,467,822

The estimated number of poultry in Denmark was 13,000,000, for the feeding of which a large quantity of cereals would be required.

The number of live-stock in the two countries for every thousand inhabitants is as follows :

		Cattle	Sheep	Pigs
		<i>No.</i>	<i>No.</i>	<i>No.</i>
United Kingdom	..	262	638	88
Denmark	804	259	524

In Great Britain for every 100 acres under crops or grass there are on an average 23 head of cattle, and in Ireland 34 ; in Denmark the number is 32, and in Belgium, before the war, there were 42. Taking cows and heifers only, there are in Great Britain 9·5, and in Ireland 11, to each 100 acres ; whereas in Denmark and Belgium, before the war, the number was twice as large as in Great Britain.

The belief appears to obtain in some quarters that the choice of farmers in this country lies between wheat and milk. It has been maintained that the breaking up of grass-lands for cereals will result in the reduction of the number of cattle. This has not been the experience of farmers in Denmark, where there is very little pasturage and yet the head of cattle is, in proportion to the cultivated area, greater than in England. Corn and live-stock are not competitive products, unless cereals are grown on a large scale for sale, leaving no home-grown keep for animals. In Denmark less than 8 per cent. of the cereals grown consists of wheat, whereas in Great Britain the percentage of wheat to other cereals is nearly 30 per cent. Now that the national emergency has passed, and large supplies of wheat are available in Canada and other British Dominions, the question arises whether the cultivation in this country of oats and green crops for feeding stock would not pay better than wheat. In considering the relative advantages of growing wheat or oats, it should be borne in mind that the rates of ocean freight for oats are from 20 to 30 per cent. higher than for wheat, which is a heavier grain. The dairymen in this country rely principally on pasturage

during the summer months, whereas in Belgium and Denmark, where pasturage is limited, the farmers by intensive cultivation raise green crops for feeding cattle. For many years before the outbreak of war a decline in the acreage of arable land was a regular feature in the annual returns of agriculture in Great Britain. The reasons generally assigned for the reduction of arable land were the increase in the cost of cultivation, the growing scarcity of qualified labour, and the fall in prices of agricultural produce, due to the intensity of foreign competition. There is less risk and outlay involved in farming grass-land, and less labour is required; it is admitted, however, that a larger head of stock cannot thus be carried, and in fact that the number may be less than under a mixed system of farming.

The following table shows the average acreage under cereals and the average number of cattle and sheep in the United Kingdom over a period of years :

Period	Wheat	Barley	Oats	Total	Number of cattle	Number of sheep
	<i>Acres</i>	<i>Acres</i>	<i>Acres</i>	<i>Acres</i>		
1873 ..	3,670,000	2,574,000	4,198,000	10,442,000	10,153,000	33,982,000
1884-88 ..	2,543,600	2,349,100	4,314,900	9,207,600	10,614,000	29,351,000
1894-98 ..	1,853,600	2,232,500	4,335,900	8,422,000	10,924,000	30,467,000
1904-08 ..	1,675,000	1,903,300	4,206,900	7,785,200	11,660,000	29,747,000
1909-13 ..	1,888,300	1,847,300	4,061,200	7,796,800	11,849,000	30,016,000
1914-18 ..	2,238,700	1,737,400	4,529,300	8,505,400	12,298,000	28,239,000
1914 ..	1,906,000	1,873,000	3,899,000	7,678,000	12,184,000	27,904,000
1918 .	2,793,000	1,839,000	5,605,000	10,237,000	12,451,000	28,849,000

Although in 1917 the cultivated area in Ireland represented 31 per cent. of the total acreage under crops and grass in the United Kingdom, her share of the total acreage under wheat was only 6 per cent., of barley 10 per cent., and of oats 30 per cent. Ireland possessed, however, 40 per cent. of the total head of cattle and 13 per cent. of the sheep. In 1918 both the acreage under cereals

and the number of cattle in the United Kingdom were greater than in any year for the last thirty-five years. England is one of the few countries in Europe where the number of sheep has been maintained in recent years. In most of the Continental countries sheep have decreased as the area of arable land has increased, and the same tendency is noticeable in the more closely settled districts of Australia and Argentina.

The value of farm and dairy produce imported into the United Kingdom is very large, and much of it comes from Denmark. The total value of imports of eggs, butter, and bacon in 1914, with the share of Denmark in the trade, was as follows :

				Total value of imports	Share of Denmark
				£	£
Eggs	8,652,800	2,546,979
Butter	24,014,276	11,038,637
Bacon	18,225,568	9,936,454
			Total ..	50,892,644	23,522,070

With closer settlement on the land and more intensive cultivation it should be possible to increase largely the home supplies of farm and dairy produce.

The average net imports of cereals (flour and meal being reduced to grain) into countries in Europe for the five years 1909-13 are shown in the following table :

	Wheat	Rye	Barley	Oats	Maize	Total
	<i>Tons</i>	<i>Tons</i>	<i>Tons</i>	<i>Tons</i>	<i>Tons</i>	<i>Tons</i>
United Kingdom ..	5,880,000	30,000	1,046,000	963,000	2,047,000	9,966,000
France ..	1,188,000	81,000	132,000	433,000	503,000	2,337,000
Belgium ..	1,340,000	124,000	330,000	119,000	438,000	2,351,000
Netherlands ..	598,000	293,000	241,000	117,000	552,000	1,801,000
Denmark ..	171,000	208,000	3,000	66,000	298,000	746,000
Norway ..	104,000	262,000	99,000	10,000	30,000	505,000
Sweden ..	191,000	97,000	—	66,000	42,000	396,000
Spain ..	168,000	—	—	—	247,000	415,000
Italy ..	1,448,000	16,000	18,000	118,000	363,000	1,968,000
Switzerland ..	460,000	18,000	25,000	181,000	101,000	785,000
Germany ..	1,859,000	—	3,245,000	47,000	812,000	5,973,000
Austria ..	1,397,000	316,000	91,000	191,000	594,000	2,589,000
Total ..	14,804,000	1,445,000	5,230,000	2,311,000	6,032,000	29,822,000

The principal exporting countries of the world for the five years 1909-13 were as follows :

	Wheat	Rye	Barley	Oats	Maize	Total
	<i>Tons</i>	<i>Tons</i>	<i>Tons</i>	<i>Tons</i>	<i>Tons</i>	<i>Tons</i>
Russia ..	4,467,000	707,000	3,769,000	1,005,000	711,000	10,659,000
Germany ..	—	671,000	—	—	—	671,000
Hungary ..	1,111,000	348,000	252,000	159,000	219,000	2,089,000
Rumania ..	1,460,000	96,000	390,000	141,000	1,138,000	3,225,000
Bulgaria ..	302,000	49,000	40,000	1,000	234,000	626,000
Canada ..	2,580,000	—	119,000	238,000	—	2,937,000
United States ..	2,910,000	24,000	180,000	64,000	924,000	4,102,000
Argentina ..	2,586,000	7,000	16,000	617,000	2,940,000	6,166,000
British India ..	1,349,000	—	226,000	—	20,000	1,595,000
Algeria ..	144,000	—	114,000	58,000	—	316,000
Australia ..	1,345,000	—	2,000	—	—	1,347,000
Total ..	18,254,000	1,902,000	5,108,000	2,283,000	6,186,000	33,733,000

The United States and Argentina send large quantities of wheat and flour to countries outside Europe ; in other respects the trade was mainly with Europe. It will be seen that the importing countries in Europe obtained 55 per cent. of their requirements from other European countries, of which Russia supplied 35 per cent. and Rumania 11 per cent. During the war the Western countries of Europe could not draw on Russia or Rumania ; this shortage was, however, largely made good by much heavier imports from the United States and Canada, as the following table will show :

AVERAGE EXPORTS FROM THE UNITED STATES AND CANADA—1914-15 TO 1917-18.

	Wheat	Rye	Barley	Oats	Maize	Total
	<i>Tons</i>	<i>Tons</i>	<i>Tons</i>	<i>Tons</i>	<i>Tons</i>	<i>Tons</i>
Canada ..	4,712,000	19,000	222,000	663,000	—	5,616,000
United States ..	5,576,000	346,000	526,000	1,512,000	1,172,000	9,132,000
Total ..	10,288,000	365,000	748,000	2,175,000	1,172,000	14,748,000

In 1917-18 the Union of South Africa exported over 200,000 tons of maize, and Brazil nearly 240,000 tons.

VARIETIES AND QUALITIES OF WHEAT.

There are many varieties of wheat grown in the world. All the best wheats grown, however, fall under the group "Common Wheats." The grain of the common bread wheat varies both in colour and quality, and may be either soft or hard. Soft wheat, termed "weak" by the miller, generally yields flour which makes a somewhat small loaf of dense texture; hard wheat, termed "strong," makes a larger and a porous loaf. As flour manufactured from hard wheat will carry a large percentage of moisture, a greater number of loaves of equal weight can be made from a given quantity of this flour than from the same quantity of flour obtained from soft wheat. The dense-eared types with weak grain give a heavier yield per acre than the hard wheats, and on this account they are largely cultivated in England, France, Germany, and in many of the older and closely settled countries. In countries with severe winters, high summer temperature and low rainfall, strong varieties with low yields are grown. The best descriptions of hard red wheat are produced in the United States, Canada, and Southern and Eastern Russia. Generally speaking, the question of strength or weakness of grain is dependent on the variety grown, and upon soil and climate; high summer temperature and low rainfall favour nitrogen content and flintiness; cooler and damper climates, on the other hand, favour starch production. It has been maintained that very high yield and superior strength could not be contained in the same variety; recent experiments made by the Agricultural Departments in India have proved, however, that this view is not correct, as excellent results, both as regards yield and quality, have been obtained from some new types which have been created by selection and cross-breeding and distributed among the cultivators in India. The average quality of home-grown wheats is low, and as wheats of the highest quality can be produced in England, efforts are now being made to obtain new varieties of prime quality and high yielding capacity. In recent years the standard of excellence

of flour has been raised, and there is a constant tendency towards the use of hard red wheats, with the result that the proportion of such wheats now grown in the world is much larger than it was twenty years ago.

Wheats of widely different characteristics are required by British millers, and home-grown wheat is nearly all mixed with Canadian and other foreign wheats, containing a high percentage of nitrogenous matter, to give the right proportion of milling and baking qualities for our bread-eaters. In many mills flour is never made from one straight lot of wheat; sometimes as many as four or five different lots are blended to obtain a well-balanced product. The chief constituents of flour are starch and gluten (albuminoids), which are found in an average proportion of 88 per cent. of starch and 12 per cent. of gluten. The gluten may be as low as 6 or 8 per cent. in soft wheats, and as high as 15 per cent. in hard wheats. The highest gluten content is possessed by the light-amber wheats of the durum group, which are grown extensively in Southern Europe and Northern Africa, and also in North America and Southern Russia. From the flour of this wheat macaroni and similar Italian pastes are prepared. The flour extraction of wheat varies in accordance with the quality of the grain. In America it is estimated that a good sample of Kansas Turkey wheat, a hard winter wheat, properly milled, will yield products approximating the following percentages: bran 12 per cent., shorts 14 per cent., total flour 72 per cent., which allows 2 per cent. for wastage and evaporation of moisture. Since the middle of the nineteenth century the milling process has been made much more efficient, partly by the substitution of rollers for millstones, and partly by improvements in arrangements for cleaning the grain and sorting out the various products obtained at different stages of the process. In normal times the average yield of flour from wheat in England is about 70 per cent., with about 28 per cent. of bran and pollards in nearly equal proportions. Usually two kinds of flour are made from one mixture. In Hungary and other parts of the Continent, where a dark flour can be sold or mixed with rye flour, yields as high as 75 and 78 per cent. are obtained, and several grades of flour are made. During the war

the flour extraction prescribed in this country varied with the quality of the wheat, but at first 81 per cent. was the standard, raised successively to 83, 88, and finally to 90 per cent. for some qualities. In Algeria the flour extraction for soft wheat was at first fixed at 74 per cent., and for hard wheat at 81 per cent. From March 1, 1917, the flour extraction in Germany was as high as 94 per cent.

THE PRODUCTION AND DISTRIBUTION OF WHEAT IN THE WORLD.

Wheat has a range of cultivation in the world, both as to elevation and latitude, greater than that of any other cereal. It is now grown successfully in the tropics and near the Arctic Circle. According to the estimates framed by the International Institute of Agriculture, Rome, the average area under wheat for the five years 1909-13 was about 250,000,000 acres, and the average yield of grain about 100,000,000 tons. These estimates do not include, however, the statistics for Serbia, Albania, Montenegro, Thrace, Greece, Finland, and Portugal in Europe, and only relate to returns from a part of Asiatic Russia and from India and Japan in Asia, to the Union of South Africa, Algeria, Tunis, and Egypt in Africa, and to the United States, Canada, Argentina, Uruguay, and Chile in America. The European States omitted from the returns produce close on a million tons of wheat. China, Persia, and Asiatic Turkey are all large producers, but unfortunately no reliable statistics are available. It has been estimated that 7,500,000 acres are devoted to wheat in the Ottoman Empire, and the production may be estimated at over 3,000,000 tons. Before the war Turkey was exporting both wheat and flour, and with more settled conditions and improved communications a great expansion may be expected in this direction. The Persians, like their neighbours in Turkey, are largely bread-eaters, and not only supply their own requirements, but are able to export small quantities of wheat. Wheat has been grown in China from the most ancient times, and the production must be very large, as it has been estimated that one-third of the population of China does not eat rice. Wheat is grown in nearly every province

in China, and is the staple food in the north. Travellers in many parts of China have recorded the fact that fields of wheat are the most common feature in the landscape. According to American Consular reports, Manchuria raises about 10,000,000 bushels of wheat, and is capable of producing 300,000,000 bushels. Wheat is grown extensively in Morocco, and in normal times the exports exceed 30,000 tons; in Abyssinia wheat is the staple food of the people. In Mexico and Brazil wheat is cultivated, and the production is increasing. It may be fairly estimated that wheat throughout the world at the outbreak of the war occupied 275,000,000 acres, and supplied about 4,000,000,000 bushels or 110,000,000 tons of grain. After deducting the seed requirements, which may be estimated at 11,000,000 tons, on the basis of 100 lb. of seed to the acre, there would be available as food approximately 100,000,000 tons of wheat, equivalent to about 75,000,000 tons of flour.

In the Northern Hemisphere the wheat harvest begins in India in March, and continues in one country or other until September, the largest area being reaped in July and August. In December and January, Australia and Argentina gather their harvests. The world's harvest is usually reckoned as being finished in February.

The following table shows the production, imports, exports, and consumption of wheat in certain countries for the five years 1909-13. (The trade in flour, expressed in its equivalent weight of grain, is included.)

Country	Average production	Average surplus of imports over exports	Average surplus of exports over imports	Average consumption
	<i>Tons</i>	<i>Tons</i>	<i>Tons</i>	<i>Tons</i>
United Kingdom	1,621,000	5,880,000	—	7,501,000
France	8,644,000	1,188,000	—	9,832,000
Belgium	405,000	1,344,000	—	1,749,000
Netherlands	131,000	598,000	—	729,000
Denmark	145,000	171,000	—	316,000
Carried over ..	10,946,000	9,181,000	—	20,127,000

Country	Average production	Average surplus of imports over exports	Average surplus of exports over imports	Average consump- tion
	<i>Tons</i>	<i>Tons</i>	<i>Tons</i>	<i>Tons</i>
Brought forward ..	10,946,000	9,181,000	—	20,127,000
Norway	8,000	104,000	—	112,000
Sweden	220,000	191,000	—	411,000
Russia in Europe, excluding Finland	18,180,000	—	4,467,000	17,713,000
Russia in Asia (9 Governments)..	4,000,000	—		
Spain	3,550,000	168,000	—	3,718,000
Italy	4,989,000	1,448,000	—	6,437,000
Switzerland	90,000	460,000	—	550,000
Germany	4,156,000	1,859,000	—	6,015,000
Austria	1,655,000	1,397,000	—	3,052,000
Hungary	4,621,000	—	1,111,000	3,510,000
Rumania	2,389,000	—	1,459,000	930,000
Bulgaria	1,190,000	—	301,000	889,000
Canada	5,571,000	—	2,580,000	2,991,000
United States	18,688,000	—	2,910,000	15,778,000
Argentina	4,282,000	—	2,586,000	1,696,000
Uruguay	195,000	—	35,000	160,000
Chile	609,000	—	65,000	544,000
British India	9,573,000	—	1,349,000	8,224,000
Japan	657,000	110,000	—	767,000
Union of South Africa	148,000	161,000	—	309,000
Egypt	928,000	212,000	—	1,140,000
Algeria	952,000	—	143,000	809,000
Tunis	169,000	20,000	—	189,000
Australia	2,241,000	—	1,345,000	896,000
New Zealand	211,000	—	20,000	191,000
Total ..	100,218,000	15,311,000	18,371,000	97,158,000

The average production of wheat in Europe for the five pre-war years, assuming that the production of the European countries

not shown in the above table was 1,000,000 tons, amounted to 53,000,000 tons. The only countries in Europe producing surplus wheat for export were Bulgaria, Rumania, Serbia, Hungary, and Russia. The remaining countries in Europe imported 14,804,000 tons of wheat, of which 7,338,000 tons were supplied by the countries mentioned above, and 7,466,000 tons were obtained from over-sea sources, mainly from Canada, the United States, Argentina, Australia and British India. During the war the surplus wheat from Russia could not be exported, and owing to the disturbed condition of the country it is probable that production has been much reduced. Since the outbreak of the war a great change in the land tenure has occurred in Russia, Rumania, and Hungary. Before the war the land in Russia was largely held in communal or in private ownership, and agriculture on the privately owned land was of a more advanced character, and gave a higher yield. Commercial farming on a large scale had made considerable progress, and wheat cultivation had been rapidly increased. In 1904 it was estimated that 17,627,000 acres of the wheat acreage was in private hands, and 26,126,000 acres in communal ownership. Under the communal system the land is held in common ownership by the villages, and is distributed at certain intervals among the members of the community for individual cultivation. The redistribution of the land tends to discourage high cultivation and manuring, and there was a growing tendency for the richer peasants to rent land from their poorer neighbours. Since the revolution took place in Russia the peasants have apparently taken possession of the land, and if the large farmers, who worked on modern lines, are eliminated, it must follow that production will decline, as the peasants will at first be poorly equipped with capital and machinery. In Rumania and Hungary the large estates have to a great extent been broken up into small farms. Eventually the productivity of the land will undoubtedly be enhanced by the new system of farming, but it will be interesting to see what immediate result the change in the ownership of the land will have on the production of cereals on a large scale for export. It remains to be proved whether the small farmer can afford to grow wheat in these countries to the same extent

as the late landowners who farmed on an extensive scale, and made wheat their main crop.

The following table shows the average production of wheat for the four years 1914-17, compared with the five years 1909-13, in Allied and Neutral countries in Europe :

Name of country	1909-13	1914-17
	<i>Tons</i>	<i>Tons</i>
United Kingdom	1,621,000	1,772,000
France	8,644,000	5,814,000
Netherlands	131,000	143,000
Denmark	145,000	164,000
Norway	8,000	9,000
Sweden	220,000	234,000
Spain	3,550,000	3,744,000
Italy	4,989,000	4,466,000
Switzerland	90,000	106,000
Total ..	19,398,000	16,452,000

France and Italy both suffered by the invasion and occupation of their territories by the enemy. Outside Europe there was a great expansion in wheat cultivation, as the following statements will show :

Name of country	1909-13	1914-17	1918
	<i>Tons</i>	<i>Tons</i>	<i>Tons</i>
Canada	5,574,000	7,379,000	5,724,000
United States	88,688,000	21,799,000	25,009,000
Argentina	4,282,000	3,579,000	5,950,000
British India	9,573,000	9,448,000	10,337,000
Australia	2,241,000	3,129,000	3,134,000
Total	40,358,000	45,334,000	50,154,000

The acreage under wheat in the above-mentioned countries in 1918 had increased by 31,000,000 acres, and was 27 per cent. larger than the average acreage for the five pre-war years. There is at the present time a sufficiency of wheat, even without the help of Russia, to meet the requirements of the world, and with an extended area under cultivation in many countries there should be no danger of shortage in the immediate future. The question of the transport and distribution of the crops is, however, a difficult one, and freight charges will be high for a long time.

The area under wheat, production, and yield per acre in various countries of the world during three periods are given in the following table. The statement is incomplete, as statistics regarding several wheat-growing countries are not available. It may be estimated, however, that the countries not represented produce about 10 per cent. of the total world's production.

Name of country	AREA SOWN			TOTAL HARVEST			YIELD PER ACRE		
	Million acres			Million bushels			Bushels per acre		
	1881-90	1891-00	1909-13	1881-90	1891-00	1909-13	1881-90	1891-00	1909-13
United Kingdom ..	2.7	2.0	1.9	76	60	60	28	30	32
France ..	17.2	17.1	16.0	301	305	317	17	18	20
Belgium ..	0.6	0.5	0.4	18	16	15	30	33	37
Netherlands ..	0.6	0.6	0.6	17	18	22	28	30	36
Denmark ..									
Norway ..									
Sweden ..									
Switzerland ..									
Russia-in-Europe ..	30.2	36.2	61.2	244	300	666	8	8	11
Portugal ..	0.7	0.7	0.9	7	7	8	10	10	9
Spain ..	9.0	9.1	9.5	100	92	130	11	10	13
Italy ..	11.3	11.3	11.6	118	123	183	10	11	16
Germany ..	4.7	4.9	4.8	104	125	153	22	25	32
Austria ..	2.7	2.7	3.0	43	43	60	16	16	20
Hungary ..	6.8	8.2	9.0	118	143	169	17	17	19
Rumania ..	3.4	3.7	4.6	42	52	88	12	14	19
Bulgaria ..	2.4	2.4	2.9	35	35	44	15	15	15
Serbia ..	3.6	3.6	3.6	40	40	40	11	11	11
Greece ..									
Turkey-in-Europe ..	95.9	103.0	130.0	1,263	1,359	1,955	13.1	13.2	15
India ..	26.7	25.2	29.2	259	243	351	10	10	12
Russia-in-Asia (9 Governments) ..	8.4	10.6	9.5	74	100	120	9	9	12
Japan ..	1.0	1.1	1.2	13	19	24	13	17	20
Canada ..	2.3	3.1	10.5	38	55	204	16	18	19
United States ..	37.1	43.1	47.1	427	559	685	12	13	14
Argentina ..	2.0	5.7	15.0	24	65	147	12	11	10
Uruguay ..	0.4	0.6	0.8	4	6	6	10	10	7
Chile ..	0.9	1.0	1.0	12	14	21	13	14	21
Union of South Africa ..	0.2	0.3	0.7	2	2	6	7	7	9
Egypt ..	1.2	1.3	1.3	12	13	34	10	10	26
Algeria ..	3.1	3.2	3.5	21	24	35	7	8	10
Tunis ..	0.8	1.0	1.3	5	6	6	6	6	5
Australia ..	3.2	4.1	7.6	27	30	90	8	7	12
New Zealand ..	0.3	0.3	0.3	8	7	7	25	25	25
Total ..	87.6	100.6	129.0	926	1,143	1,736	10.5	11.3	13.4
Grand Total ..	183.5	203.6	259.6	2,189	2,502	3,691	11.9	12.0	14.1

One of the most important features in the above statement is the rapid increase in the area under wheat in European Russia. The average area sown advanced from 36,000,000 acres between 1891-1900 to 61,000,000 acres between 1909-13, and the average production rose from 300,000,000 bushels to 666,000,000 bushels. The extension of wheat cultivation had, moreover, by no means reached its limit when the outbreak of war checked further progress. The returns from Italy are also remarkable, as the increase of 60,000,000 bushels in the third over the second period was almost entirely due to the increase in the yield per acre. With the exception of Portugal, Serbia, Greece, and Turkey, regarding which countries reliable statistics are not available, every country in Europe obtained a higher yield per acre. Compared with the yields of 42 bushels per acre in Denmark, 37 bushels in Belgium, and 32 bushels in England and Germany, the average yield of 15 bushels per acre for the whole of Europe is low, but with more scientific methods of agriculture and improved seed there can be little doubt that better results will be obtained in the backward countries.

Outside Europe the greatest advance in wheat-growing has been made in the following countries :

	1891-00	1909-13	1918
	Area sown	Area sown	Area sown
	Million acres	Million acres	Million acres
Canada	3.1	10.5	17.3
United States	43.1	47.1	58.9
Argentina	5.7	15.0	17.9
India	25.2	29.2	35.5
Russia-in-Asia	10.6	9.5	14.5*
Australia	4.1	7.6	11.0
Total ..	91.8	110.9	155.1

*Area sown in 1915.

There was a general improvement in the average yield per acre, which is, however, still very low in most of the countries. The crops in Australia suffer from drought, and in Argentina from drought and locusts, and in both these countries the average quantity of seed sown is only a little more than one bushel to the acre. In India rust is the chief enemy, and accounts for the low average yield. Rust is the most widespread and serious disease from which wheat suffers; neither spraying nor seed treatment have been successful in checking the disease. Rust-resistance varies greatly geographically, and depends also on the kind of rust: varieties resistant in one locality may not be so in another. Known rust-proof varieties are generally poor yielders, but by selection and hybridization some progress has been made in raising good-cropping rust-proof types of wheat in different countries.

That there has been a great improvement in wheat-growing is evident from the fact that, whereas the total area sown advanced by less than 25 per cent. in the third over the second period, the total production rose by nearly 48 per cent. In 1898 the late Sir William Crookes estimated that the wheat-growing countries could only add 100,000,000 acres to the wheat area of the world, and this additional area would produce 1,270,000,000 bushels, just enough to supply the world's requirements up to 1931. About half the allotted period had elapsed in 1913, and although only 50,000,000 acres had been added to the wheat area, the production had increased by 1,191,000,000 bushels, nearly equal to the total production estimated for the additional 100,000,000 acres. Since the outbreak of the war, further extensions, amounting to nearly 50,000,000 acres, have been added, and vast areas of new land are still available in Canada, Argentina, Brazil, Australia and Siberia. In the United States and European Russia further extensions can be made, and in Asiatic Turkey and Northern Africa under settled conditions and with improved communications much larger areas will be brought into cultivation. When the forecast was made in 1898 it was apparently not recognized that the North Western Provinces of Canada possessed some of the most favourably situated wheat-growing lands in the world, and that the great

sheep-runs of Australia and Argentina, with their scanty rainfall, were also suitable for wheat-growing.

It is difficult to estimate the total area of new land in the world which could be made available for wheat-growing; it must, however, be far in excess of the area now devoted to wheat. In Australia it has recently been estimated that the area, with over 10 inches of rain in the growing season, available for grain in New South Wales, Victoria, South Australia and Western Australia, is nearly 50,000,000 acres. There are also immense areas of good land situated in the drier zones of the four States mentioned above which under irrigation or with improved methods of cultivation and improvement in drought-resisting wheats will eventually come under cultivation. In Queensland and the Northern Territory there are great areas of land, both within and outside the tropics, where climate and soil are quite suitable for wheat-growing. In South America new lands suitable for wheat-growing probably equal those available in Australia, and Canada and Siberia will eventually provide even larger areas for wheat. Not only are there large reserve areas of land available to meet the growing requirements of the world, but the average yield per acre is being steadily improved. Under ordinary agriculture and with improved types of drought and rust-resisting wheats there is every reason to expect that the present average yield of 13 bushels per acre will be doubled, and with intensive cultivation the yield could be trebled. The fears expressed in some quarters that there will be a wheat crisis before the end of this century are without foundation. It has been predicted that the maximum world's production of wheat will be 6,000,000,000 bushels, and that the earth may in the end be able to feed permanently 1,000,000,000 wheat-eaters. With an average yield of 26 bushels to the acre the existing wheat area of 300,000,000 acres would produce 8,000,000,000 bushels of wheat.

PRODUCTION AND TRADE IN THE CHIEF COUNTRIES OF
THE WORLD.

United Kingdom. The following statement shows the wheat production and the quantities and values of wheat and flour imported since 1861.

Period	Average annual production of wheat	WHEAT		FLOUR		Percentage of flour to total imports of wheat and flour	Average value of wheat per ton
		Average imports	Average value	Average imports	Average value		
	<i>Tons</i>	<i>Tons</i>	£	<i>Tons</i>	£		£ s. d.
1861-75 ..	3,000,000	1,724,000	20,087,000	252,000	4,041,000	12·7	11 13 0
1876-90 ..	2,272,000	2,791,000	26,343,000	647,000	8,865,000	18·8	9 8 9
1891-05 ..	1,520,000	3,720,000	25,540,000	971,000	9,424,000	20·7	6 17 3
1906-10 ..	1,575,000	4,843,000	39,550,000	614,000	6,493,000	12·6	8 3 3
1911-14 ..	1,628,000	5,125,000	43,484,000	528,000	5,673,000	9·3	8 9 8
1915-17 ..	1,766,000	4,669,000	71,275,000	579,000	11,783,000	11·0	15 5 3

There was a great fall in the price of wheat during the latter half of the nineteenth century, brought about by the development of new wheat lands abroad, and the remarkable reduction in the cost of sea-borne transport. An average level of about 50s. a quarter was maintained over long periods up to 1874, and then for ten years the average was about 45s. After this the price fell rapidly until in 1894 a minimum of 22s. 10d. was reached. For about ten years prices ruled low, and then there was a recovery, and the average price in 1909 was 36s. 11d. In 1910-11 the price fell to 30s. 11d., and in 1913 the average price was 32s. 4d. After the outbreak of war, owing to the difficulties of transport, there was an enormous rise in prices. In 1873, 3,700,000 acres were devoted to wheat in the United Kingdom, but with the fall in prices land rapidly went out of cultivation, and in 1904 the acreage sown was only 1,400,000, the lowest level reached. For the five pre-war years the average area under wheat was about 1,900,000 acres; during the war the wheat acreage was largely extended under the stimulus

of the Corn Production Act, until in 1918 the acreage was 2,800,000. Agriculture is one of the most essential industries, as the permanent material prosperity of a nation depends largely on the full development of the agricultural resources of the country. Unfortunately farming in this country did not prosper during the period when large and cheap supplies of corn, meat, and dairy produce were imported from abroad, with the result that between 1871 and 1913 the area under arable cultivation in Great Britain was reduced by 4,000,000 acres, or by more than one-fourth, and a large proportion of the rural population either emigrated or moved into already congested industrial centres in search of employment.

The average consumption of wheat (imported flour expressed in its equivalent weight in grain) in the United Kingdom for the five years 1909-13 was 7,500,000 tons, of which 20 per cent. was produced in the country, and the balance imported. The sources of our wheat supplies are varied, but those countries which send substantial and regular contributions are few.

The shares of the principal countries from which the United Kingdom draws supplies of wheat are shown in the following table; flour, expressed in its equivalent weight in grain, is included:

	1907	1908	1909	1910	1911	1912	1913	1914	1915	1916	1917	1918
Canada ..	13.1	16.4	17.2	17.1	16.9	21.9	22.5	29.7	23.5	23.7	21.3	25.1
Australia ..	7.4	5.3	9.2	11.5	13.0	10.4	8.7	10.5	0.1	3.7	10.5	4.6
India ..	15.8	2.7	12.9	15.1	18.0	20.5	15.3	9.1	13.7	4.9	2.5	0.8
Total from British Empire ..	36.4	24.5	40.0	44.1	48.5	53.1	46.5	50.6	37.5	32.6	34.6	30.6
United States ..	28.8	36.3	22.2	15.2	17.9	20.9	34.8	35.3	47.2	63.0	58.7	52.3
Argentina ..	19.0	29.2	17.8	12.8	13.3	15.3	12.3	5.6	12.0	4.0	6.1	15.5
Russia ..	9.9	4.7	15.8	24.3	16.2	7.3	4.1	6.3	0.8	—	0.1	—
Total from Foreign Countries ..	63.6	75.5	60.0	55.9	51.5	46.9	53.5	49.4	62.5	67.4	65.4	69.4

The outstanding feature of the trade during the war was the great increase in the imports from the United States.

The imports of wheaten flour since 1909, with the principal sources of supply, have been as follows :

	1909	1910	1911	1912	1913	1914	1915	1916	1917	1918
	<i>Tons</i>	<i>Tons</i>	<i>Tons</i>	<i>Tons</i>	<i>Tons</i>	<i>Tons</i>	<i>Tons</i>	<i>Tons</i>	<i>Tons</i>	<i>Tons</i>
From British Empire ..	129,200	160,000	188,100	235,500	225,400	173,800	168,500	236,800	290,400	366,300
Foreign countries	423,300	338,000	315,100	273,900	372,900	329,100	355,000	261,100	426,500	951,600
Total	552,500	498,000	503,200	509,400	598,300	502,900	523,500	497,900	716,900	1,317,900
From Canada	103,000	139,200	163,400	200,200	208,400	161,300	168,000	211,300	197,700	278,200
Australia ..	26,100	20,400	22,200	34,500	17,500	12,400	100	25,000	92,500	84,000
France ..	26,700	21,900	20,000	18,500	15,000	18,200	3,200	—	—	—
Germany ..	29,300	29,400	14,100	18,500	22,800	10,800	—	—	—	—
Austria-Hungary	5,400	6,200	5,300	5,800	4,000	2,800	—	—	—	—
United States	346,400	251,400	250,800	201,100	307,800	277,900	337,000	259,100	402,100	898,200
Argentina ..	4,200	5,000	4,400	5,000	9,500	2,900	4,400	800	800	100
China ..	—	—	—	—	—	—	—	—	5,800	46,500

The United States and Canada are the principal contributors, followed by Australia ; before the war France and Germany sent fairly large quantities of flour. During the last ten years the milling industry in the United Kingdom has been greatly developed ; the average quantity of wheat imported between 1896-1900 was 3,332,000 tons, whereas the average imports for the five years 1909-13 amounted to 5,166,000, an increase of 1,834,000 tons. The imports of flour fell, however, from an average of 1,055,000 tons in the earlier period to 532,000 tons in the later period. In 1917, owing to the question of freight, imports of flour were above the average of the ten preceding years, whilst in 1918, they were greatly in excess of the average for 1896-1900. At one time flour milling was carried on at the principal centres of production, but the great development in the sea-borne trade, and low freights, led to the

establishment of flour mills in many of the chief ports in this country, such as London, Liverpool, Hull, Glasgow and Leith, where most of the wheat is now dealt with. The average quantity of wheat milled in the United Kingdom during the five years 1909-13 was about 6,800,000 tons, which, on the basis of 70 per cent. of flour, would yield about 4,800,000 tons of flour, 900,000 tons of bran, and about the same quantity of offals. The development of the milling industry is a most satisfactory feature in the trade of the country, as not only does the industry provide employment for capital and labour, but the by-products produced in the country are of great value to the farmers. Unfortunately in pre-war years these by-products were extensively exported to Denmark and Germany. The export trade in flour is not of great importance: in 1913 it amounted to about 80,000 tons, valued at £856,000, the chief customers being Russia, Norway, the Canary Islands, Egypt and Malta. There is a considerable export trade in biscuits, worth £1,561,000 in 1913; in 1917 the value of this trade was £1,752,000 but the volume was 20 per cent. less than in 1913.

Canada. The rapid development of wheat-growing in Canada is reflected in the following statement.

Period			Acreage	Production
				<i>Tons</i>
1881-90	2,300,000	1,000,000
1901-10	5,900,000	2,950,000
1909-13	10,522,000	5,571,000
1914-17	13,771,000	7,379,000
1918	17,344,000	5,724,000

Though wheat is grown in nearly every province the great wheat belt is the western prairie, and the finest wheat region is the rich valley of the Saskatchewan, where the grain grows to perfection, and the yield averages over 26 bushels to the acre. On the prairie lands, which were first taken up, wheat is being grown year after year without rotation and without manure. In time this must lead

to soil exhaustion, but there are vast tracts of land still available, the land area of the three Prairie Provinces amounting to 446,000,000 acres. The further north wheat is grown, up to a certain limit, the better it is. The bulk of the prairie wheat is spring sown, and the chief dangers with which the farmer has to contend are hail in August and early autumn frost. The prevalence of smut is another draw-back, which lowers the yield and value of the grain.

The average exports of wheat and flour for the five years 1909-13 were 2,580,000 tons of grain, and for the four years 1914-17, 4,712,000 tons. The United Kingdom takes nearly the whole of the grain, and about two-thirds of the flour exports. In 1913 the exports of grain amounted to 2,100,000 tons, and of flour to 350,000 tons; the corresponding figures for 1916 were 3,800,000 tons of grain and 435,000 tons of flour. Canada also supplies British South Africa, the West Indies, Denmark and Norway with flour.

Australia. Wheat is the most important farm crop in Australia; approximately half the cultivated area is under wheat. The area under wheat is, however, small relatively to the area suitable and available for the cultivation of this crop. The question of the available land and the limits of profitable cultivation was closely studied after the outbreak of war, and it has been estimated that the present average production of 103,000,000 bushels in the four principal producing States, New South Wales, Victoria, South Australia, and Western Australia, could be increased five-fold. In addition Queensland has large areas which will undoubtedly be cultivated in wheat as the country develops. The average yield of wheat per acre in Australia is low, in New South Wales the average is under 11 bushels, and in South Australia, where the crop frequently fails to mature, the average yield is only 8 bushels. With such small returns wheat only pays in Australia because of the low cost of production. Actual figures of the cost of growing wheat on large farms in districts of less than 20 inches mean annual rainfall have shown that the crop can be sown and harvested for from 21s. to 23s. per acre, yielding 12 bushels. The quality of the wheats grown in Australia is not equal to the hard Canadian wheats, but the grain is of even grade, and has good milling qualities.

The following statement shows the progress made in wheat cultivation in Australia :

Period			Acres under wheat	Production
				<i>Tons</i>
1860-1	182,000	70,000
1881-90	3,200,000	720,000
1908-09 to 1912-13	6,791,000	2,241,000
1913-14 to 1916-17	10,727,000	3,129,000

In 1916-17 the production was 4,139,000 tons. The average quantity exported during the five pre-war years was 1,345,000 tons. During the war large stocks of wheat accumulated in Australia as shipping was not available for its transport. In normal times the United Kingdom takes over 70 per cent. of the total exports of grain, and about 15 per cent. of the flour. Australia supplies flour to South Africa, Portuguese East Africa, the Straits Settlements and the Philippine Islands. In 1913 it was estimated that 37,000,000 bushels, or about 1,000,000 tons of wheat, were milled in Australia.

India. Wheat is grown in all the provinces of India, but principally in the north-western part of the Indo-Gangetic plain, and in the Central Provinces, Central India and Bombay. About 35 per cent. of the total area is under irrigation either in whole or in part.

The area under wheat, and the production since 1891, are shown in the following table :

Period			Average area under wheat	Average production
				<i>Tons</i>
1891-1900	25,200,000	6,200,000
1905-09	28,000,000	8,500,000
1909-13	29,200,000	9,570,000
1914-17	31,070,000	9,440,000
1918	35,470,000	10,330,000

In recent years the extension of irrigation in the Punjab has brought into cultivation large areas of land. The large increase in the cultivation in 1918 was due, however, to the substitution of wheat for other crops. In Upper Burma, especially in the Shan States, land suitable for wheat is available, and will be cultivated when communications are improved and settlers attracted to the land. There is no immediate prospect of largely extending the wheat area in the principal wheat districts of India, where most of the land is cultivated, except by substituting wheat for other crops; the production can, however, be increased by improved methods of cultivation and by employing improved strains of wheat. The introduction on a large scale of the improved Pusa wheats, which are rust-resisting, and give a greater yield than some of those at present grown, will, in time, increase the production. Wheat and barley are often grown together, and consequently the wheat shipments frequently carry a percentage of barley. Under the terms of the Indian wheat contract of 1907, the admixture of barley was limited to 2 per cent. In recent years a great improvement has been made in shipping grain free from dirt, but the 2 per cent. allowance of barley is sometimes exceeded. Soft wheats are largely grown in India for export; for local consumption hard wheats are preferred. In the drier districts the durum varieties are cultivated, and a few hard winter wheats are to be found in the North. The substitution of superior types of wheat for the soft wheats now grown would not only meet the local demand, but also the requirements of the export trade. The exports of wheat from India, which average less than 15 per cent. of the total production, are influenced by the yield of other food crops, and in times of scarcity the exports fall away. Owing to the failure of the monsoon rains in 1918, wheat is being imported into India from Australia.

Between 1909-13 the exports of wheat and flour averaged 1,349,000 tons of grain. The United Kingdom was the best market for the grain; Continental countries also drew supplies from India. In 1913-14, 80,000 tons of flour were exported, principally to Eastern countries. The flour-milling industry in India is making good progress, but the bulk of the wheat consumed locally is converted

into flour in the primitive native mills, and the flour extraction is much greater than is customary in Western countries. The consumption of wheaten flour in India is increasing.

Mesopotamia. This country is one of great promise for cereal production. Before the war wheat and barley grown in Mesopotamia were shipped from Basra. The volume of the trade was not large, and it was carried on under great difficulties. Plans had been prepared for constructing important irrigation works which would have brought large areas of land into cultivation. Under Turkish rule, however, little progress had been made in carrying out these works, and the exactions of the local officials gave little encouragement to the Arab cultivators to extend their holdings. Since the war, under British administration, large areas have already been brought into cultivation by the extension of irrigation canals, and under a just rule cultivators are now able to enjoy the fruits of their labour. Communications by road and river have been improved, and Basra, transformed into an up-to-date port, promises in the near future to be an important centre of the cereal trade; its position in regard to India is of some importance, as the surplus crops of Mesopotamia will be a safeguard for India when the monsoon rains fail in that country.

British East Africa. During recent years the cultivation of wheat has been taken up by farmers with considerable success. The Nasin Gishu Plateau, covering an extensive area at an altitude of from 6,000 to 7,000 feet, is an excellent wheat country as regards both yield and quality; the country is flat and free from timber, and offers every facility for growing wheat on a large scale. Proximity to the railway is one of the important factors in growing wheat for export, but with improved communications there should be an outlet for the surplus produce of the country. Rust has proved troublesome, but as the result of experiments, rust-resisting varieties of seed are being found, and it should be possible for this country to produce wheat on a large scale.

Northern Africa. More than four-fifths of the total area cultivated in Egypt is capable of growing wheat, but so long as cotton remains the highly remunerative crop it is, there is very

little chance of extending wheat cultivation. During 1915 and 1916, owing to restrictions in the cultivation of cotton, the wheat area was extended and there was a surplus of grain for export. Under normal conditions, however, Egypt does not grow enough cereals for her own requirements.

Algeria and Tunis produce at present about 1,200,000 tons of wheat, of which Algeria exports about 150,000 tons. Hard durum wheats are largely grown by the natives, and the yield per acre is very low. The French colonists in Algeria, who cultivate the ordinary French varieties of wheat, obtain very good returns.

Wheat and barley are extensively grown in Morocco, and before the war the wheat exports averaged about 30,000 tons. With the improvement in the position of the natives under a better government, more land will come under cultivation, and by the provision of roads and railways opening up new districts, and reducing the cost of transport to the ports, there should be a great advance in the export trade. There are numerous flour mills in Morocco, and also factories for making Italian pastes, for which the hard Moorish wheat is very suitable.

Russia. Before the war wheat cultivation in Russia was making great progress, especially in Little Russia, and the regions of the Middle and Lower Volga, where the finest qualities of wheat are grown. In the Caucasus, Turkestan and Western Siberia the wheat areas were also being extended. Wheat exports had been advancing, and for the five pre-war years amounted on an average to nearly 4,500,000 tons a year. The quantity exported varied greatly from year to year : in 1908 it was as low as 1,500,000 tons, and in 1910 it was over 6,000,000 tons. Siberia has hitherto been little developed as a wheat-growing country ; in Eastern Siberia rye is grown, and forms the chief food of the people. This country, with the neighbouring Chinese Province of Manchuria, contains vast tracts of land suitable for wheat. Owing to the upheaval in Russia and the utter disorganization of all means of transport, it cannot be expected that exports of cereals on a large scale will be renewed, even for some time after peace has been restored.

United States. At the present time the United States is the greatest wheat-producing country in the world. The estimated production of wheat in 1919 is 1,300,000,000 bushels, or about 34,800,000 tons, which represents more than one-fourth of the world's production of this cereal. The following statement shows the great advance made in the cultivation since the outbreak of the war :

Period			Average area	Average production	Average yield per acre
			<i>Acres</i>	<i>Bushels</i>	<i>Bushels</i>
1891-1900	43,100,000	559,000,000	13.0
1900-09	46,678,000	659,509,000	14.0
1909-13	47,068,000	685,259,000	14.5
1914-17	53,038,000	799,320,000	15.0
1918	58,852,000	917,000,000	15.5
Estimated 1919	1,300,000,000	

The Government encouraged farmers to grow wheat by various concessions and by fixing the price of wheat in advance of sowing ; for the 1919 crops the farmer was guaranteed \$2.20 per bushel, which compares favourably with the average farm price of 87 cents per bushel obtained between 1909 and 1913. Prior to the outbreak of war exports had been declining : the average exports for the five pre-war years were 2,900,000 tons, whereas between 1900 and 1902 they had averaged 5,790,000 tons. This decline was caused partly by the small annual increase in production, and also by the rapid increase in population, and by a considerable increase in per capita consumption. With increased production, and economy in consumption during the war, exports have rapidly advanced and averaged 5,576,000 tons between 1914-17. The exportable surplus for 1919 is estimated at from 350,000,000 to 400,000,000 bushels, or rather less than one-third of the estimated production. Various kinds of wheat are grown in the United States. The hard spring wheat, comprising about one-third of the total production, is grown principally in Minnesota and the two Dakotas, and is of fine quality, similar to the wheat produced in the Middle Volga region of Russia.

About two-thirds of the wheat is winter sown, and a very large proportion of this is raised in the Central Western States, of which Kansas is the most important. The wheats grown in the Pacific and Western Intermontane districts are generally soft and starchy. Much unimproved land suitable for wheat still remains, and the yield per acre, which is low, can be improved. The flour manufacture of the United States is of great magnitude, and the flour export trade much the largest in the world. Between 1903-07 the exports of flour averaged 1,335,000 tons; before the war the average had fallen to about 1,000,000 tons, but during the war the average was nearly 1,500,000 tons. The United Kingdom is one of the principal customers for flour; South American countries also draw their supplies largely from this source. During the war France and Italy had to indent extensively on the United States.

Argentina. Although at so early a date as 1585 wheat grown in La Plata was milled at the city of Cordoba, it was not until 1890 that Argentina ceased to import both wheat and flour. In recent years the production of wheat has increased to a remarkable extent, as the following statement will show:

Period	Area under wheat	Production	Exports
	<i>Acres</i>	<i>Tons</i>	<i>Tons</i>
1890-91	1,981,000	790,000	370,000
1899-1900	8,027,000	2,587,000	1,804,000
1907-08	14,227,000	4,900,000	3,400,000
1909-13	15,785,000	4,282,000	2,586,000
1914-17	17,864,000	5,900,000	

The principal type of wheat cultivated is the semi-hard red grain of Italian origin, which does not degenerate; soft French and Russian varieties, and also hard durum wheats for the local manufacture of macaroni are also grown. In the colder southern regions a fine quality of hard winter wheat is now being cultivated. The principal wheat areas are in the provinces of Buenos Ayres, Cordoba, and Santa Fé, but it is probable that the wheat belt will

tend gradually more south, and that La Pampa will eventually become the chief source of supply. The breaking up of large estates has enabled the people to buy small farms, and has encouraged settlement on the land. The average yield of wheat per acre is small, as the crops are liable to damage from locusts and drought. With improved cultivation and abatement of the locust plague Argentina should be able to raise much larger crops. There are numerous flour mills in the country, and exports of flour have averaged about 120,000 tons, the bulk of which goes to Brazil.

Brazil. Wheat was formerly grown in the three most southern States, but the cultivation was abandoned because of the prevalence of rust. The advance in the material condition of the people of the country has resulted in a demand for wheaten bread in place of bread made from mandioca flour, and to meet this demand, flour and wheat have been largely imported from Argentina. For some years past the Government have given every assistance and encouragement to farmers to grow wheat, and good progress has been made in the southern States, where there are extensive areas of land suitable for wheat and also well provided with transport facilities. There appears to be every prospect that Brazil will be able to supply her own requirements in course of time, and also have an exportable surplus.

THE GROWTH OF THE SUGARCANE.*

BY

C. A. BARBER, C.I.E., Sc.D., F.L.S.

II

IN the last article the growth of the sugarcane plant was traced from the planting of the seed or set to the stage when the actual canes appear above ground. This embraces the first of two well defined periods of growth. The second period covers the whole subsequent growth in the cane field and consists essentially of the lengthening and ripening of the crop of canes. To recapitulate, the manner in which the main stem gives off leaves, branches and roots was described, together with the way in which each of these branches develops. A complex mass of shoots is thus formed underground, each of which sends up its leaves above the surface, for the purpose of obtaining fresh supplies of food from the air while, at the bases of the leaves, it gives off series of ever thicker roots which penetrate the soil, and supply it with watery solutions of the salts needed for its further growth. In this growth, the parts, originally laid down in one plane, alter their relative positions according to their individual needs of space in the ground and in the air, and it was pointed out that many of them are crushed out of existence in the process. The roots and leaves develop much more rapidly than the stem bearing them, and, when the latter emerge from the ground, the leaves are already three to

* Reprinted from the *International Sugar Journal*, November, 1919.

four feet in length, and the plant is furnished with a mass of fibrous roots, penetrating deep into the soil. This, the first period of growth, is mainly subterranean, and lasts until the stems of different orders of branching begin to appear between the bases of the lower leaves. The main points to be kept in view, in this period, are the upward increase in the thickness of the stems, the protrusion of buds from the leaf axils and the increasing length and thickness of the new sets of roots formed on successive joints. The new leaves, meantime, become larger and broader at their base, soon completely encircle the joint till they overlap and enclose the younger parts in a set of enveloping sheaths. The length of successive joints also increases until all the growing parts are raised above the level of the ground.

The early stages of growth were traced both in cane seedlings and in plants grown from sets, and it will not be out of place here to refer to the reasons why the latter method of propagation is always adopted in sugarcane cultivation. While flowering is very common in the sugarcane, seedlings cannot be grown on an estate scale for several reasons. There are many kinds in which flowers are not found at all. In others, the flowers in the arrow are imperfect or, even when apparently perfect, turn out to be sterile. Again, when good seed is found in abundance, it is so small that planting from seed would be a very difficult and tiresome operation on a plantation. The time taken between sowing and reaping, as has already been pointed out, is much greater in the case of seed-sown plants than in those grown from cuttings. While a set will produce its bunch of canes in about 12 months, the plant produced from seed needs more like 16 to 18 months for it to reach maturity. As will be seen later, the canes in a bunch vary a good deal among themselves, but this is much more prominent in canes grown from seed. An even field cannot be expected from seed-grown canes. Lastly it is only within recent years that it has become generally known that good canes can be raised from seed, but, even if it had not been so, the vegetative method of planting would always have held, for the following reason. Plants produced from sets are exactly like their parents, and all the good and bad qualities of the variety are handed

down intact. The set is merely a piece of the parent plant cut off and given a prolonged existence. On the other hand, all seedlings differ from their parents. Sometimes these differences are so small that they are immaterial, and this is the case with cereals and other plants cultivated for their seeds; but, in the sugarcane, potato, apple, mango, orange, the variations are so great that a large number of worthless plants appear if seed is sown. Thus, besides the lateness of the crop grown from sugarcane seed, it would consist of a heterogeneous mass of canes differing in ripeness, sweetness, thickness, and every conceivable property. This subject has been introduced here because the writer has, not infrequently, been asked to send seeds of good cane varieties, raised on cane seedling experiment stations, for growth on a crop scale.

The second period of growth consists, primarily, of the elongation of the stems by the formation, in rapid succession, of much larger joints than those found underground, in other words, of the formation of canes. The two periods are much more pronounced in grasses or grain crops, and the growth in the second period is, in these cases, obviously for the purpose of lifting the flower into the air, so that pollination can be effected, and raising the fruit from the ground so that it can mature in the sun and be scattered abroad. The wild sugarcanes are still propagated by seed, and the habit has survived in the cultivated forms, although it is no longer necessary for them to be spread in this way. As we have noted, many cultivated canes still form flowers and seeds, and this formation closes the second period of growth. When the young canes are detected between the lower leaf-sheaths, they have already reached about normal thickness, and practically nothing is added afterwards in this direction. Further, no more branching or root formation is expected or desired. This is due, in the first place, to the absence of the forcing influence of the moist earth, and, in the second, to the repressive influence of light, at any rate on root formation. "Shooting" and "Rooting" therefore cease abruptly, and, although the buds and root-eyes continue to be formed in each joint as usual, they remain dormant or inactive. But it is because of their presence that it is possible to plant any cut piece of cane, with the

certainty that it will grow into a new plant. The moment darkness, together with moist earth, are present, both bud and root push their way out and commence growing.

Branching and rooting of the aerial portion of the cane plant are undesirable from many points of view, and it will be well to consider the matter in some detail. They weaken the plant, use up stored sugar and, by changing a further portion of it to the uncrystallizable form, decrease the richness of the juice. The canes of a healthy field crop should be as free as possible of lateral shoots and masses of roots, and, if these appear, we must adopt any means at hand to check their development. In many moist climates, where the rain collects in the bases of the older leaves, we find, on tearing them off, that the buds are shooting and the roots protruding. The usual remedy for this is to strip away the dying leaves at intervals. This "trashing" of the canes is regularly done in certain tracts, and might, perhaps, be extended elsewhere. In North Bengal, for instance, where trashing is unknown, it is easy, after stripping the canes at harvest, to mark the exact points in the formation of the cane, when the rains set in and when they ceased to flood the land. About half-way up the cane, the joints bear protruding buds and masses of crumpled roots, while these are not present above or below. It is accordingly suggested that, at the outburst of the monsoon, a thorough trashing should be tried, to see if this loss of energy can be prevented.

When canes fall down and lie on the ground, shoots and roots are not long in making their appearance on the joints of the fallen plant, owing to the comparative absence of light and the contact with the moist soil. The canes, in recovering their normal position, become curved and twisted, and the difficulty of reaping and handling are increased. Various means are adopted in different places to prevent this "lodging" of the canes, from earthing them up at the base to tying them roughly together. Probably the latter method reaches its greatest development in the Godavari district of the Madras Presidency, where abundant irrigation and rich soil, coupled with forcing heat, cause the canes to grow to an enormous height (Plate XVII, fig. 1). In one case a field was observed by the writer

in this locality, with an average height of twenty-five feet. As this part of India is liable to be visited by violent cyclonic storms during the growing season (Plate XVII, fig. 2) a series of " wrappings " have been introduced, and form an important part of the cane cultivation. Several of the older, but still firmly adhering, leaves of the cane are twisted to form a band, with which it is tied to its neighbours, while still quite small; and the whole field is treated in this way (Plate XVIII, figs. 1 and 2). In a well-grown field as many as seven successive wrappings are done, and the last two or three are performed from the tops of immense three-legged stools; the operation costing a great deal then, because of its comparative slowness. But this is not all. The bunches of cane shoots thus brought together are fastened to upright bamboos sunk in the ground, and these are of three sizes. At first thin bamboos support the canes of a single bush; later on, larger and thicker ones bring several bushes together, and, lastly, tall, thick bamboos complete the work and unite several of the full grown clumps together. The bamboos, especially the large ones, last for several years and are carefully stacked at harvest time; but it will be readily understood that the practice, as a whole, is a very expensive one. The following notes were compiled at the Samalkota Sugar Cane Farm. The wrappings in a fairly good crop may be put down as costing Rs. 37-12-0 per acre. The bamboos, which are floated down the Godavari River in rafts from the hills, will cost Rs. 100 per acre in a freshly started plantation, and, after that, an annual charge of Rs. 26 should cover the cost of replacements. After three or four years, the old bamboos may be sold for odd fencing, etc., at from Rs. 6 to Rs. 8 per acre per annum. There is thus a recurring charge for bamboos of about Rs. 20 per acre per annum.

Shooting of the cane, often accompanied by rooting, is met with when there is any sudden check in growth. This check may be due to accidental injuries, the attack of insect pests or other causes, and, if arrows are formed, the upward growth of the cane ceases. In these cases, the roots and leaves still actively growing and sending up masses of formative material, the stream of nutriment is sufficient to force the buds to activity and they shoot out and form bunches of



Fig. 1. A tall plot of Striped Mauritius Canes, 12 months old.
These produced 7 tons of jaggery to the acre.



Fig. 2. The effect of a Cyclonic Storm on an unwrapped field.



Fig. 1. Wrapped Cane, Samalkota Farm.



Fig. 2. Full stand of Red Mauritius Canes, 10 months old.

green leaves. As flowering often takes place before reaping, this is difficult to check. The cutting of the young arrows makes little or no difference, and the formation of seed is of far less detriment to the crop than the shooting of the buds. Many of the new seedlings flower profusely, which is not to be wondered at when we remember that they arise of necessity from freely flowering parents. But the matter should receive some attention, and, when possible, such new varieties should be introduced as have a minimum of this habit. When flowering commences, all growth in length ceases in the sugar-forming joints, and thus the weight of cane per acre is reduced; but it does not appear that flowering is of itself detrimental to the richness of the juice, because, as the results of many analyses, it has been found that at harvest canes that have arrowed frequently show a richer juice than those that have not.

When all is said and done, the best way in which to rid one's self of undesirable characteristics in plants is by the selection and growth of varieties which prove themselves to be free from them in the locality concerned. We have now reached the stage of fighting diseases in crops by indirect methods. The *sereh* in Java was mastered by abolishing ratoons, raising planting material in separate hill nurseries, but chiefly by the introduction of new kinds of cane; and most faults in the canes can be combated by a similar trial of new varieties, coupled with good cultivation and special attention to drainage—in other words, in giving the newly introduced canes every chance of normal, healthy growth. And the matters of shooting and rooting and the lodging which encourages them should be approached in the same manner. Some varieties shoot and root much more than others, and the extent to which they do so varies greatly in different places. Many new seedlings with excellent properties of yield and juice are liable to fall, and show this tendency more in some climates and soils. A cane which will stand erect in a stiff, clayey soil, will, for instance, fall all over the place in light alluvium; and this accounts for the extraordinary favour extended to *White Tanna* in the light soils of Bengal. The most interesting case met with by the writer was that of a seedling, raised in the Coimbatore sugarcane station, which produced a tufted bush of shoots with two or three long canes emerging therefrom.

These canes never rose from the ground, but crept along its surface. One of them was found winding in and out like a snake among the neighbouring seedlings, and, upon being extricated, measured twenty feet in length.

REPORT OF THE LINCOLN TRIALS.*

THE Report of the Tractor Trials held under the auspices of the Society of Motor Manufacturers and Traders, during the month of September 1919, is at last published. It is rather an imposing publication, perhaps it is fairer to say that in importance it compares well with the event which it concludes. I use the word "concludes" advisedly, since, as was widely advertised prior to the trials, they were not complete, nor was their purpose served in its entirety, until the observations of the interested spectators were supplemented by the advice of the experts who were appointed judges and technical advisers. Properly to have fulfilled its purpose, there can be no denying that it should have been issued within, at the most, a few weeks of the conclusion of the trials. However, this much can at least be said: the compilers have done their work well, and the Report is worth waiting for.

It is conveniently divided into four sections. The first part gives the regulations and conditions governing the trials; it is concluded by a map of the ground. The second portion gives the report of the technical adviser and includes a number of useful tables. The third part is also the work of the technical adviser; it embodies technical descriptions of each and every tractor, each description being accompanied by an illustration of the machine to which the text refers, as well as a reproduction of the chart which graphically shows the tractor's behaviour during the dynamometer test of its drawbar capacity. The fourth part contains the judges' report of the tractors and implements. There are, in addition, some supplementary illustrations, showing the types of dynamometer used, and the form of interchangeable rim used by the Garner tractor. The Report occupies in all just one hundred

* Reproduced from *Country Life*, dated 17th January, 1920.

pages, of which it may be said that a single one omitted would have been missed.

TECHNICAL ADVISER'S THE LION'S SHARE.

The technical adviser, Mr. G. W. Watson, appears to have been responsible for the lion's share of the work. His Report is summarized under ten heads; (1) Drawbar dynamometer tests, (2) Ploughing resistance dynamometer tests, (3) Ploughing heavy land, (4) Ploughing cliff land, (5) Haulage tests, (6) Threshing tests, (7) Mechanical construction, (8) Safety of operation, (9) Results of test on oil, (10) Brief descriptions of each make and type of tractor engaged.

With the method of carrying out the dynamometer tests, I do not propose to deal. I described it at some length a short time ago. The important results are tabulated, in company with essential technical data regarding each tractor, in Table I, which also contains much useful information directly obtained as a result of the drawbar tests. Perhaps that column which will make the most direct appeal is the one in which the capital cost per 100 lb. of drawbar pull is given for each tractor. The actual horse power available at the drawbar, when the tractor is travelling at its normal speed, is calculated and tabulated, as is also a figure for the "efficiency of adhesion" of the machine. The last named is obtained by proportioning the drawbar pull to the weight of the tractor. Its value, as Mr. Watson points out, lies rather in the indication which it gives of the efficacy of the type of spud employed. No information, unfortunately, is vouchsafed as to the type of spuds actually used by each tractor during the trials, so that the information will be of direct use to the individual manufacturer only, although the user will, of course, reap the benefit ultimately.

PLOUGHING RESISTANCE.

It was a novel and sound idea to ascertain the ploughing resistance of every field in which trials were held. Mr. Watson states that it was his intention to go further than this, and test each individual type of plough, from which bold venture he was prevented

by the difficult transport conditions then prevailing. For strictly accurate results such tests are perhaps necessary. At the same time the labour involved would be considerable, as I doubt whether it would be sufficient to make comparative tests in one class of soil only, and to test each type of plough in each class of soil would be work for an army of technical advisers, even of such as Mr. Watson evidently is. The results of these tests are given, in conjunction with other data relating to the performances of the tractors in the fields concerned. That is to say, the ploughing resistance of the heavy land is tabulated with the figures which give the performance of the machine in that land (Table II), while those obtained from the light land are similarly collated with the data in connection with the work performed there. In the heavy land, the soil is, with two exceptions, classed as heavy clay, and the resistance, apart from the two exceptions named, varies from 10·90 lb. to 12·30 lb. per square inch of the sectional area of the furrows cut. That is to say, for a furrow 10 in. wide by 5 in. deep, the resistance would vary from fifty times 10·90 lb. to fifty times 12·30 lb., namely, 595 lb. to 615 lb. The difference in the nature of the soils worked on the second day of the trials is much greater than this. They vary from light loam through medium to heavy loam, and the ploughing resistance from 7·91 lb. to 11·40 lb. per square inch, so that a plough cutting a furrow 10 in. wide by 5 in. deep might call for an effort of anything between 395 lb. and 570 lb.

Other figures of interest in these two tables (II and VI) refer to the delays which occurred to the tractors during the day. The stoppages were remarkably few. Lengthy stops only occurred in connection with the ploughs. Mechanical troubles of any consequence occurred only in respect of two tractors, and apart from these the maximum time lost by any tractor was thirteen minutes.

ACRES PER HOUR.

Most of the important data have been separated from Tables II and VI, and are repeated in smaller tables, of which III, IV and V give the ploughing capacity of the tractors in acres per hour, the fuel cost per acre, and the fuel cost per hundred pounds of drawbar

pull respectively while operating in the heavy soil. Tables VII, VIII and IX give corresponding figures for the work performed in the light land. On account of their simplicity, I do not doubt that these tables will make the most direct appeal to the lay reader, particularly as the information which they give answers so aptly the questions which the farmer naturally asks when he is endeavouring to discover the type of tractor most suited to his needs. The figures will no doubt surprise many. In no case, for example, on the heavy land does any tractor accomplish the "even time" of tractor working ploughing "an acre an hour." The nearest approach is made by the Fiat, which turned over an average of 0·87 or nearly seven-eighths of an acre per hour. On the light land one tractor exceeded the average of an acre per hour. The tractor concerned was, however, the only steam-engined machine present. Of internal combustion engined machines the Fiat again showed to best advantage, accomplishing 0·93 acre per hour. Twenty-three out of thirty-four tractors averaged more than half an acre an hour on heavy land, and all but five of the thirty-seven which demonstrated on the light land exceeded that amount. The average of all the tractors on the heavy land was 0·578 acre per hour, and on the light land 0·653 acre per hour.

FUEL COSTS.

In regard to cost of fuel per acre most divergent results are recorded. Certain machines used petrol throughout, and therefore show to considerable disadvantage on the fuel account, even if they may have the advantage of the others in other directions. Apart from these, however, the difference between best and worst is almost 200 per cent. in excess of the former. On the heavy land, for instance, whereas the Blackstone Track-layer ploughed an acre at a cost of 3s. for fuel, and tops the list on that account, the Illinois used paraffin costing 8s. 11d. while doing the same work. It is only fair to point out that the latter machine was cutting soil a little stiffer than that which fell to the portion of the Blackstone, and was, moreover, ploughing to a depth of 6 in. as against the Blackstone's 5 in. An even greater discrepancy is observable between the

performance of the paraffin users on the light land. While the Fiat, which again heads the list, cuts an acre for 2s. 5d. the corresponding figure for the Pick is 8s. 4d. and in this case, although the Pick was cutting half an inch deeper than the Fiat, the soil which it was working was considerably lighter in texture than was the case with the least expensive worker. Some of the difference may be due to variation in plough draught, although there is no evidence either for or against this assumption. In any event, he would be a bold man who would assert that any one plough could be 200 per cent. more difficult to haul than the lightest draught implement made. The average cost of fuel per acre on the heavy land, considering paraffin-burning tractors only, was 5s. 1½d., and on the light land 4s. 2½d.

FUEL COST IN RELATION TO DRAWBAR EFFORT.

I was at first somewhat puzzled and I anticipate that many readers of the Report will be similarly at a loss to understand the object in publishing Tables V and IX, which give the cost per hundred pounds of drawbar pull per acre ploughed. After consideration I have come to the conclusion that the object is that of correcting the previous tables which give the cost per acre, in which tables the incidence of drawbar pull, or depth ploughed, is not taken into account. Thus in the heavy land the Blackstone Track-laying tractor costs least of any for fuel per acre ploughed, but when the pull exerted is taken into account it is beaten by the Clayton and the Overtime, both of which pulled four-furrow ploughs as against the Blackstone's three. However, since the soils worked by the three tractors were pretty much the same in all cases and the depth of ploughing the same too, it would appear that the smaller machine is really the more economical after all. The evidence, however, is not conclusive.

HAULING AND THRESHING.

All the machines which demonstrated their ploughing capacity were not entered for the hauling and threshing. As a matter of fact, only eleven took part in the hauling test and thirteen in the

threshing trials. The results were generally satisfactory but figures showing the comparative performances of the tractors are not given for reasons which are explained in the Report. The outstanding lesson of the haulage test was the superiority of rubber tyres. Every machine fitted with rubber tyres made the ascent of the somewhat steep hill successfully. Of the steel-tyred tractors only the heavy weights, which the judges state are too heavy to be suitable for tillage operations, were able to perform satisfactorily. That the tractors all came through the threshing test without trouble only goes to confirm what I have pointed out in these columns, that given a tractor engine which is in good condition, and provided that the corn is fed judiciously, there is hardly a tractor on the market which is not capable of driving a full-sized thresher. It is when the machine has to be hauled from place to place that trouble commences, the standard types of thresher weighing five tons.

MECHANICAL CONSTRUCTION.

As regards the mechanical construction of the tractors, the Report is a favourable one. One or two exceptions to this general rule are mentioned, and the technical adviser's opinion as regards safety of operation is also favourable, except as regards two machines. No special results seem to have accrued from the tests of the used engine oil; whatever there are seem to be negative. Probably the truth is that the trials were not of sufficient length to affect the oil one way or the other.

DESCRIPTIONS: THE DYNAMOMETER CHARTS.

With the descriptions of the tractors we do not need to concern ourselves here. Each is followed by a brief specification of the machine, the data therein contained being largely the same as that which is tabulated in Table I, with additions. The dynamometer chart for each machine concludes each description.

JUDGES' REPORT.

The judges have been outspoken, but somewhat brief. Not a few manufacturers will find themselves disagreeing very strongly

with the opinions expressed, which in a way is as it should be. At the same time, there will be many, I anticipate, who will complain, with some show of justice, that the judges have not been sufficiently explicit. It hardly seems fair, for example, to say, as occurs in the Report of one machine, that "Its performance.....was not satisfactory," without amplifying the statement by indicating the direction wherein lay the fault. Reading through the Report, it becomes apparent that the authors are of the opinion that the limit of tractor weight for satisfactory use on the soil, except when the weather is particularly favourable, is 2 tons 10 cwts. With that opinion there will be few to disagree. On the other hand they appear to think that the heavier machines are well adapted for haulage on the road, and the farmer who wishes for a general purpose machine will have to decide for himself as to how far he can reconcile these conflicting conditions. Where a machine is considered as a hauling engine, the tendency appears to have been to condemn it if it is not properly equipped with a double set of brakes and springs. The judges, too, have set their faces against any tractor which, in preparation for threshing, has to be reversed into position; in several cases they state: "It is inconvenient to set in position on account of the fact that it must be placed with its rear wheels towards the thresher." They are equally intolerant of the tractor which has to be set transversely to the belt drive.

THE REPORT.

The Report is available to the general public, and I am asked to state that all enquiries concerning it should be addressed to the Tractor Trial Organizer, the Society of Motor Manufacturers and Traders, Limited, 83, Pall Mall, London, S. W. 1. Its price is 3s. post free and remittances must accompany orders.

Notes

MOTOR TRACTOR TRIALS AT NAGPUR.

A VERY interesting "meet" was held at Nagpur during the week beginning on the 16th February, 1920, for the purpose of testing motor tractors. Of the tractors which were expected to compete only five were present. These were as follows:—

			<i>Rated</i>	<i>Weight</i>
			<i>B. H. P.</i>	
F. I. A. T.	25	6,000 lb.
Lanson	25	6,500 "
Austin	25	2,900 "
Fordson	22	2,600 "
Cleveland	21	3,000 "

Though the numbers were few yet the interest of these trials lies in the fact that it is the first time that tractors have been tried in black cotton soil. These black cotton soils dry and crack very deeply and, when cultivated, turn up in big concrete-like blocks. Under these conditions a light machine, travelling partly on the land and partly in the furrow, is completely at sea, however useful such light machines have proved themselves in other parts of India.

The F. I. A. T. with a drawbar adjustment, which enables the tractor to work on the land while having sufficient power and weight to stand the consequent side pull, was quite capable of tackling any class of land put before it.

Neither the drivers nor the implements were up to the standard of the tractors. The former obviously lacked the experience which will come with time. In some cases drivers did not lift their ploughs at the headlands and thus put a strain on the plough beams which no implement is designed to stand.

The implements were all of the self-lift type. Riding ploughs would have made much better work, the extra man involved is of little moment compared to the resulting advantages.

None of the tractors had any mechanical trouble during the week in spite of the severe strain involved, and this is a good proof of the standard of mechanical perfection to which tractors have now attained.

The Agricultural Department of the Central Provinces is to be congratulated on the success of the demonstration. Messrs. Clouston, Allen, Plymen and the other members of the staff, along with the numerous visitors who were enrolled as judges and observers, had a very arduous week.

It is obvious, however, that with some 50-60 makes of tractors presently on the market, trials of a more extensive nature are required. Trials for all India are needed, and from the data provided by them, the various provinces will be able to select according to their special requirements. [G. S. HENDERSON.]

* * *

CATTLE SALE AND DEMONSTRATION AT PUSA.

A PUBLIC AUCTION of surplus cattle from the pedigree dairy herd was held at Pusa on the 17th March, 1920. These sales, first started in 1917, have created a considerable amount of interest and have undoubtedly focussed public attention on the possibilities of dairy cattle breeding in India. The cattle were brought forward in excellent bloom considering the character of the season, and the following prices were obtained.

			Rs.	₹	P.
Montgomery bull-calves	14	1,525	0 0
Cross bred bull-calves, Montgomery cow × Ayrshire			15	705	0 0
bull			6	1,260	0 0
Montgomery cows	6		
			TOTAL	3,490	0 0

The next sale will be held in November and, among other stock, over 20 cows are expected to be exposed.

On the morning preceding the sale a demonstration on tractor implements was held. Both sale and demonstration were well

attended. A representative gathering of planters was present and general opinion testified to the enormous importance that the tractor movement foreshadows to India. [G. S. HENDERSON.]

* * *

THE USE OF SOME SALT WATER PLANTS AS FODDER.

THERE are a number of plants the use of which as fodder is well known to the cultivators in one tract, but is altogether unknown in another. This may be due to the fact that good nutritious fodder may be scarce in the first and ample in the other. The poverty of the agricultural areas in the Ratnagiri district has taught its people to put to use every bit of available land for agricultural purposes, and when it is not possible to make such use of it, an attempt is made to employ such plants as may be naturally growing on poor land for some economic purpose. In that district fodder-growing areas are poor and limited. The cultivators therefore have to fall back upon such plants as can naturally grow on the poorest of soil and can take care of themselves. In the tidal rivers and creeks along the west coast also, there are immense areas which are naturally covered with several kinds of mangroves, and with grasses and holly-like shrubs. The people of the Ratnagiri district have learnt long ago the use of these plants as fodder. These plants grow in salt water and naturally contain a considerable quantity of salt. They are, nevertheless, fed, even in normal years, as green fodder to milch cattle and if possible to work animals also.

The holly-like *Marandi* (*Acanthus ilicifolius*) is a spiny plant about three to four feet in height. It is erect and unbranched. Its leaves resemble those of holly (*Ilex*) from which it derives its specific name. The plant is generally cut before it flowers and chopped up into small bits of three inches long. They are then beaten with a strong rod so that all the spines are completely broken down. This is the only precaution that is to be taken in preparing the stuff for feeding. For one animal a man can prepare the stuff, ready for feeding, in half an hour. In the beginning a small quantity of *bhusa* or cotton seed or any other similar food may be added to the feed before giving it to cattle. About twelve to fifteen

pounds per day can be given to an animal which begins to like it in about a couple of days. When the animal is accustomed to it, the *bhusa* and cotton seed may be dispensed with. The spiny nature of the plant need not deter one from using it; the spines are not at all dangerous as in the case of the prickly pear; even young boys can be readily trained to prepare fodder from it.

The *tivir* (*Avicennia officinalis*) is a large spineless shrub and covers large areas in the creeks. This plant can be readily distinguished from other mangroves by its peculiar roots which project in large numbers above the surface of the mud. Branches of this plant may be cut and fed to cattle.

The *lavi* (*Æluropus villosus*) is a small grass about twelve to fifteen inches long and grows in salt water mud. This is simply pulled out of the mud with its roots. It is first washed in salt water so as to remove the greater part of its mud and again in fresh water to remove every trace of mud. It is immediately fed to cattle—preferably to milch cattle. About ten to fifteen pounds is given to every animal. There is however a limited quantity of this grass available in the tidal creeks.

The first two plants are very common in all the creeks and rivers of the west coast of India. They are apparently never utilized by cattle owners of the Kolaba, Thana and Surat districts. They are strongly recommended to use these plants as long as they are available and thus increase the supply of fodder. [H. P. PARANJPYE.]

* * *

EXPERIMENTS WITH PEANUTS IN MESOPOTAMIA.

AN interesting account of a successful experiment which has been carried out at Fellujah, on the river Euphrates, about thirty-eight miles west of Baghdad, with peanuts (or groundnuts) has been furnished by the United States Consul at Baghdad. One of the most remarkable facts about Mesopotamian agriculture is the scarcity of oil-seeds among the crops grown in the country. Practically no oil-seeds are grown, with the exception of a little sesamum and linseed. In other oriental countries oil-seeds are quite commercial crops. India, for instance, has its linseed, cotton-seed, coconut, gingelly,

rape-seed, sesamum and peanuts, while Egypt has its cotton and sesamum and China its soy-beans. Considerable interest, therefore, is attached to an experiment with peanuts carried out at the Fellujah gardens. The plot was only a small one, about one-tenth of an acre being sown. The crop was sown in June and lifted in November. The person in charge of the garden had no experience of this crop, and sowed somewhat too thickly and overwatered, yet the crop, when first lifted, gave 2,550 lb. of nuts, which, when dried, gave 1,800 lb. per acre. Peanuts are already in considerable demand in the country, large quantities being imported from India. At present the nut is consumed in a parched state or is used for making sweetmeats. Later on, when the production exceeds this local demand, the surplus will find a ready export as an oil-seed. The variety grown at Fellujah is a tight-husked variety, with a very attractive bright-red skin, known as the small Japanese. It was not known in Mesopotamia before, and local merchants who have seen samples have been much interested. It has the advantage of being quick growing, requiring comparatively little water, and being easy to dig. Demonstration plots at various centres were to be arranged for this year by the Agricultural Department, and it should be possible to establish this crop on a commercial scale in a short time. [*Journal of the Royal Society of Arts*, dated Feb. 6, 1920.]

PERSONAL NOTES, APPOINTMENTS AND TRANSFERS, MEETINGS AND CONFERENCES, ETC.

WOODHOUSE-SOUTHERN MEMORIAL FUND.

THIS fund is now closed. The total amount of the fund is Rs. 2,578-4-0 (including Rs. 24-2-0 interest allowed by the Bank and deducting Rs. 7-14 discount on cheques). Rs. 317 was specially contributed by subscribers for the memorial to Mr. Southern and Rs. 180 for that to Mr. Woodhouse. The final allotment, therefore, is :—

			Rs.	As.	P.
Woodhouse Memorial	1,220	10	0
Southern Memorial	1,357	10	0

It is proposed to send Rs. 1,200 to the Government of Bihar and Orissa and Rs. 1,300 to the Government of the Punjab for the purpose of endowing a Memorial Prize in the Provincial Agricultural College. The balance of Rs. 78-4 will be expended on enlarged photographs of the deceased officers to be hung in the Council Room of the Agricultural Research Institute at Pusa.

J. MACKENNA,

23rd March, 1920.

*Agricultural Adviser to the
Government of India.*

THE HON'BLE SIR CLAUDE HAMILTON ARCHER HILL, K.C.S.I., C.I.E., has resigned his office as an Ordinary Member of the Council of the Governor General of India, in charge of the Department of Revenue and Agriculture, with effect from the 11th April, 1920.

* * *

THE HON'BLE SIR THOMAS HENRY HOLLAND, K.C.S.I., K.C.I.E., has been appointed to be a Temporary Member of the Council of the Governor General of India in the vacancy caused by the resignation of the Hon'ble Sir Claude Hamilton Archer Hill, K.C.S.I., C.I.E.

* * *

THE HON'BLE MR. R. A. MANT, C.S.I., I.C.S., Secretary to the Government of India in the Department of Revenue and Agriculture, has been granted privilege leave for three months with effect from the 27th March, 1920. He reverts to the Punjab on the expiry of the leave.

* * *

MR. J. HULLAH, I.C.S., has been appointed to officiate as Secretary to the Government of India in the Department of Revenue and Agriculture, with effect from the 27th March, 1920.

* * *

THE services of MR. J. MACKENNA, M.A., C.I.E., I.C.S., Agricultural Adviser to the Government of India and Director of the Agricultural Research Institute, Pusa, are replaced at the disposal of the Government of Burma, with effect from the afternoon of the 30th April, 1920.

* * *

MR. F. M. HOWLETT, B.A., F.E.S., Imperial Pathological Entomologist, is appointed to the charge of the office of the Forest Zoologist at the Forest Research Institute and College, Dehra Dun, in addition to his own duties, with effect from the 7th February, 1920.

* * *

MR. C. M. HUTCHINSON, B.A., M.A.E.B., Imperial Agricultural Bacteriologist, has been granted combined leave for eighteen months, with effect from the 10th April, 1920.

MR. J. H. WALTON, B.A., B.Sc., Assistant Agricultural Bacteriologist, has been appointed to officiate as Imperial Agricultural Bacteriologist during the absence of Mr. Hutchinson on leave.

*
* *

DR. W. H. HARRISON, D.Sc., Imperial Agricultural Chemist, has been granted combined leave for eighteen months with effect from the 15th April, 1920, or any subsequent date from which he may avail himself of it.

*
* *

WE offer our hearty congratulations to Mr. H. E. Annett, Agricultural Chemist, Bengal, who has been awarded the degree of D.Sc. by London University in recognition of his work of alkaloids.

*
* *

COLONEL A. SMITH, F.R.C.V.S., Principal, Bengal Veterinary College, has been granted combined leave for six months from the 25th March, 1920.

*
* *

MR. P. J. KERR, M.R.C.V.S., I.C.V.D., Superintendent, Civil Veterinary Department, Bengal, on return from leave, is appointed temporarily, with effect from the 26th March, 1920, to the post of Second Imperial Officer, Bengal Veterinary College, and to act as Principal of that College during the absence, on leave, of Colonel A. Smith.

*
* *

MR. D. QUINLAN, Superintendent, Civil Veterinary Department, Bihar and Orissa, was on privilege leave for a fortnight with effect from the 25th February, 1920.

*
* *

MR. P. B. RILEY, M.R.C.V.S., has been appointed to the Indian Civil Veterinary Department, with effect from the 21st March, 1920, and has been posted to Bihar and Orissa as Second Superintendent, Civil Veterinary Department.

*
* *

COLONEL J. FARMER, C.I.E., F.R.C.V.S., Chief Superintendent, Civil Veterinary Department, Punjab, has been granted

combined leave for eight months with effect from the 20th February, 1920.

* * *

MR. T. F. QUIRKE, M.R.C.V.S., has been confirmed in the Indian Civil Veterinary Department, with effect from the 8th February, 1920, and has been placed on special duty in the office of the Chief Superintendent, Civil Veterinary Department, Punjab.

* * *

THE University of Bombay has conferred the degree of M.A.G. on Mr. G. S. Kulkarni, Acting Assistant Professor of Mycology, Agricultural College, Poona.

* * *

THE HON'BLE DIWAN BAHADUR L. D. SWAMIKANNU PILLAI, Avargal, I.S.O., is appointed to act as Director of Agriculture, Madras.

* * *

MR. R. CECIL WOOD, M.A., from date of relief of his appointment as acting Director of Agriculture, is appointed to act as Deputy Director of Agriculture, Livestock, Madras.

* * *

RAI BAHADUR K. RANGA ACHARYAR, Avargal, Government Lecturing and Systematic Botanist, Coimbatore, has been on privilege leave for two months from the 22nd March, 1920.

* * *

MR. G. EVANS, C.I.E., M.A., Deputy Director of Agriculture, Central Provinces, has been granted an extension of leave for two months.

* * *

MR. C. W. WILSON, M.R.C.V.S., Superintendent, Civil Veterinary Department, Central Provinces, has been granted combined leave for eight months from the 19th March, 1920.

* * *

MR. W. N. HARVEY, Deputy Director of Agriculture, Northern-Eastern Circle, Gorakhpur, has been granted combined leave for

eight months and eight days with effect from the 15th March, 1920.

* *

MR. A. McCracken, I.C.S., Burma, has been appointed Assistant Rice Commissioner, Rangoon, from the 12th February, 1920.

* *

CAPTAIN T. D. STOCK, who has been appointed by His Majesty's Secretary of State for India to the Indian Agricultural Service and who has been posted to Burma to fill the post of Economic Botanist in the local Department of Agriculture, reported his arrival at Rangoon on the forenoon of the 24th December, 1919.

* *

MR. D. F. CHALMERS, I.C.S., Director of Agriculture, Burma, has been granted privilege leave for six months with effect from the date on which he may avail himself of it.

* *

MR. C. R. P. COOPER, I.C.S., Officiating Registrar, Co-operative Societies Department, Burma, is placed in charge of the Office of Director of Agriculture, Burma, in addition to his own duties, in place of Mr. D. F. Chalmers proceeding on leave.

Reviews

Les Amendas et l' Huile de Palme (Palm Kernels and Palm Oil.)—By
E. BAILLAUD and A. STIELTJES. Institut Colonial de Marseille ;
1920.

THIS volume is chiefly an analysis of the evidence given before the British Committee on Edible and Oil-producing Nuts and Seeds, which reported to Parliament in June 1916. It contains much that is of interest to India, especially in view of the discussion on the conservation of oil-cakes in the country which took place at the recent meeting of the Board of Agriculture at Pusa.

The oil-producing nut and seed industry is one which was greatly influenced by the war, and the authors consider that England alone of the countries engaged has been able to profit by developing its market for edible oils. The major part of this development has been concerned with the African oil palm, *Elaeis*, but coconut and other oil-producers, such as groundnut, sesamum, etc., have also shared. Great Britain has, in fact, not only captured a great part of the trade in oil palm products formerly centered in Hamburg, but has also encroached extensively on the hitherto undisputed supremacy of Marseilles in the other edible oils.

It is pointed out that, before the war, Germany, having a people who consume edible oils largely under normal (pre-war) conditions, concentrated on the crushing of products such as *Elaeis* kernels and copra which give a high yield of oil, while in England, edible oils being in relatively small demand, the seeds such as linseed giving the best cakes and industrial oils were most dealt in. This initial advantage in the edible oil industry was developed by the Germans by means of protective duties which enabled the German manufacturer to obtain a higher price for his oil in Germany than

that at which he could export it, by subsidies to shipping companies and probably (though absolute proof of this is not advanced) to the manufacturers, and by low rates of transport to factories in the interior of the country. It is believed that the Germans could sell their oils in Germany at £ 2 a ton more than English manufacturers could get in England. The German machinery was also more efficient than that used in England which left considerably more oil in the cake. The net result was that Germany sent annually about 50,000 tons of palm kernel oil to England in the years just preceding the war and a further considerable quantity reached England in the form of margarine through the intermediary of Dutch houses. On the other hand it was impossible for other countries to sell oil or margarine in Germany at a profit on account of the heavy duties on these products, while the raw material was allowed to enter free.

The war put an end to this. The result was an enormous development of the edible oil industry in Great Britain. In February 1919, the production of margarine in England was 8,000 tons a week as against 1,500 tons in 1913, and was approximately sufficient to meet the British demand. The total production of vegetable oils reached 331,808 tons in 1917 and 380,270 tons in 1918. Almost all classes of oil-producing nuts and seeds shared in this increase: the importation of groundnuts rose from 15,000 tons in 1913 to 137,750 tons in 1917; of copra from 14,000 to 50,400 tons, and of palm kernels from 36,000 to 249,000 tons (equalling the pre-war German figure) in the same period. This occurred without any special Government action other than the encouragement by the Food Controller of importation by private agency, and the control of the margarine factories so as to secure the application of uniform formulæ. Maximum prices were fixed for the latter. Arrangements were made for the imposition of an export tax of £ 2 per ton in British colonies on oil palm products to foreign countries but no action on this was taken during the war (though steps have recently been taken to enforce it).

In France, Government acquired the whole output of its colonies and prohibited importation from other sources. The

result was disastrous. When groundnuts were selling in England at 74 francs per 100 kilos, palm kernels at 63 francs and copra at 87 francs, French manufacturers had to pay 126, 142 and 215 francs respectively. Against a normal importation of 256,000 tons of undecorticated groundnuts, 237,000 tons of decorticated groundnuts and 112,000 tons of copra, France could only get in 1918, 73,000, 9,000 and 21,000 tons respectively, plus 40,000 tons of palm kernels and 14,000 tons of palm oil. Even by paying twice the price prevailing in England, factories could not obtain anything like their requirements : many had to close, while England was building up a new industry.

Furthermore, beyond a first effort in 1916, nothing was done in France to popularize the use of oil palm cake, which was scarcely known previously. The result is that at present it fetches less than half the price of coconut cake. Yet intrinsically it is scarcely inferior to the latter and in Germany was actually preferred before the war for feeding milch cattle, giving, it was claimed, a slight increase in fats in the milk. In England efforts were made by the Board of Agriculture, Experiment Stations and Agricultural Colleges to advocate its use, and there was an ample supply available at relatively low prices when other feeding stuffs were scarce. It is now getting a price which is in relation with its intrinsic value and is in the neighbourhood of coconut cake though of course inferior to that of linseed.

It is not to be wondered at, therefore, that as soon as the importation of copra again became feasible, the French industry abandoned the use of oil palm kernels, and in the spring of 1919 sent about 80,000 tons of the latter to Germany out of their stocks of about 100,000 tons.

Another circumstance tending to aggravate the situation in France, in view of the fact that the French colonies cannot at present supply more than one-fifth of the French demand, is the growth of the oil crushing industry in the eastern tropics during the later stages of the war. This growth is especially noticeable in India, the Dutch Indies and the Philippines. No less than 53 oil crushing factories have been recently started in the Dutch colonies,

42 of which are in Java. These have a capacity of some 250,000 tons of copra annually. In the Philippines also the export of coconut oil has grown from 13,500 tons in 1915 to 115,280 tons in 1918 while copra has fallen in the same time from 82,000 to 55,000 tons.

All this, the authors think, will make it most difficult to revive the French industry behind tariff walls. They consider that the proper course to take is to stimulate production in such commodities as groundnuts, copra and palm kernels in the French colonies while entering into open competition with rival countries in the purchase and sale of oil nut and seed products. [E. J. B.]

* * *

Blood-sucking Insects of Formosa. Part I. Tabanidæ (with Japanese species).— By Dr. T. Shiraki, Government Entomologist, Taihoku Agricultural Experiment Station, Formosa; 1918. 445 pages and 11 plates. (No price stated.)

THIS monograph of the Japanese species of Tabanidæ includes several that are recorded as found in India and Burma also, the following species being listed as occurring within Indian limits, viz., *Chrysops dispar*, *C. mlokosiewiczi*, *Tabanus sexcinctus*, *T. bicinctus*, *T. abbreviatus*, *T. indianus*, *T. crassus*, *T. sanguineus*, *T. fulvimedius*, and *T. birmanicus*, all of which are fully described and illustrated in the coloured and line plates. The descriptions are unusually full, covering sometimes eight pages of print, so that this book should be of considerable assistance to all engaged in work in Indian Tabanidæ. [T. B. F.]

* * *

**ANNUAL REPORT OF THE DISTRICT AGRICULTURAL
ASSOCIATION OF BIRBHUM AND ITS BRANCH
ASSOCIATIONS FOR 1919-20.**

THE report begins with a general survey of the progress made since the main Association was constituted fifteen years ago. A new epoch in its short history began in the year 1918-19 when a realization of the difficulties of satisfactorily meeting the needs

of agriculturists scattered throughout the district set decentralization afoot. Rapid strides were made in the organization of Branch Associations to deal with smaller territorial units each comprising a *thana*, and, by the end of the year, 30 such associations were established. A steady growth in their development has continued, and their number has now reached 87. Each Association has 20 to 50 members, but some have as many as 150. Their work has spread into many channels bringing practical and visible benefits not only to their members but also to local cultivators in general. Some of their most noteworthy activities, worthy of emulation by similar associations in other districts, were the successful inauguration of useful schemes of re-excavation of irrigation tanks, construction of *bunds*, embankments and canals, consolidation of agricultural holdings, opening of agricultural night classes in Middle English Schools in different parts of the district and conservation of manures. We congratulate Mr. G. S. Dutt, I.C.S., under whose able guidance, as President, the Associations have made such healthy and commendable progress. [EDITOR.]

NEW BOOKS

ON AGRICULTURE AND ALLIED SUBJECTS

1. Essays on Wheat, by Prof. A. H. R. Buller. Pp. xv+339. (London : Macmillan and Co., Ltd.) Price, 2.50 dollars.
2. Physiology of Farm Animals, by T. B. Wood and Dr. F. H. A. Marshall. Part I : General, by Dr. F. H. A. Marshall. Pp. xii+204. (Cambridge : At the University Press.) Price, 16s. net.
3. A Biochemic Basis for the Study of Problems of Taxonomy, Heredity, Evolution, etc., by Prof. E. T. Reichert. Part I. Pp. xi+376+34 plates. Part II. Pp. vii+377-834. (Washington : Carnegie Institution.)
4. A Text-book of Quantitative Chemical Analysis, by Dr. A. C. Cumming and Dr. S. A. Kay. Third Edition. Pp. xv+416. (London : Gurney and Jackson ; Edinburgh : Oliver and Boyd, 1919.) Price, 12s. 6d. net.
5. Chemical Calculation Tables : For Laboratory Use, by Prof. H. L. Wells. Second Edition, revised. Pp. v+43. (New York : John Wiley and Sons, Inc. ; London : Chapman and Hall, Ltd., 1919.) Price, 6s. 6d. net.
6. Applied Economic Botany : Based upon Actual Agricultural and Gardening Projects, by Dr. M. T. Cook. (Farm Life Text Series.) Pp. xviii+261. (Philadelphia and London : J. B. Lippincott Co., 1919.) Price, 7s. 6d. net.
7. Agriculture and the Farming Business, by O. H. Benson and G. H. Betts. Pp. xvi+778. (London : Kegan Paul and Company, Limited, n.d.) Price, 10s. 6d. net.

THE following publications have been issued by the Imperial Department of Agriculture in India since our last issue :—

Bulletins.

1. Notes on Practical Salt Land Reclamation, by G. S. Henderson, N.D.A., N.D.D. (Bulletin No. 91.) Price, As. 6.
2. *Syngamus laryngeus* in Cattle and Buffaloes in India, by A. Leslie Sheather, B.Sc., M.R.C.V.S., and A. W. Shilston, M.R.C.V.S. (Bulletin No. 92.) Price, As. 6.
3. A Preliminary Note on the Behaviour in North India of the first batch of Sugarcane Seedlings distributed from the Sugarcane-breeding Station, Coimbatore, by T. S. Venkatraman, B.A. (Bulletin No. 94.) Price, As. 8.

**LIST OF AGRICULTURAL PUBLICATIONS IN
INDIA FROM 1ST AUGUST, 1919,
TO 31ST JANUARY, 1920.**

No.	Title	Author	Where published
GENERAL AGRICULTURE.			
1	<i>The Agricultural Journal of India</i> , Vol. XIV, Part V, and Vol. XV, Part I. Price Re. 1-8 or 2s. per part : annual subscription Rs. 6 or 9s. 6d.	Edited by the Agricultural Adviser to the Government of India.	Messrs. Thacker, Spink & Co., Calcutta.
2	Scientific Reports of the Agricultural Research Institute, Pusa (including the Report of the Imperial Cotton Specialist) for 1918-19. Price Re. 1-4 or 2s.	Issued from the Agricultural Research Institute, Pusa.	Government Printing, India, Calcutta.
3	Report on the Progress of Agriculture in India for 1918-19. Price Re. 1-4 or 2s.	Agricultural Adviser to the Government of India, Pusa.	Ditto.
4	Proceedings of the Board of Agriculture in India held at Pusa on the 1st December, 1919, and following days (with appendices). Price As. 12 or 1s. 3d.	Ditto.	Ditto.
5	Notes on Practical Salt Land Reclamation, Pusa Agricultural Research Institute Bulletin No. 91. Price As. 6.	G. S. Henderson, N.D.A., N.D.D., Imperial Agriculturist, Pusa.	Ditto.
6	A Preliminary Note on the Behaviour in North India of the first batch of Sugarcane Seedlings distributed from the Sugarcane Station, Coimbatore, Pusa Agricultural Research Institute Bulletin No. 94. Price As. 8.	T. S. Venkatraman, B.A., Ag. Government Sugarcane Expert, Madras.	Ditto.
7	The Effect of Manuring with Superphosphate and Sannai on the Yield of Crops on Indigo Planters' Estates in Bihar—especially of Rabi Crops in the season 1918-19. Pusa Research Institute Indigo Publication No. 6. Price As. 6.	W. A. Davis, B.Sc., A.C.G.I., Indigo Research Chemist, Pusa.	Ditto.

LIST OF AGRICULTURAL PUBLICATIONS—*contd.*

No.	Title	Author	Where published
<i>General Agriculture—contd.</i>			
8	Guide to Agricultural Section, Pusa. (<i>Not for sale.</i>)	Compiled by Agricultural Section, Pusa.	Government Printing, India, Calcutta.
9	Annual Report of the Board of Scientific Advice for India for the year 1918-19.	Issued by the Board of Scientific Advice for India.	Ditto.
10	Quinquennial Report on the Average Yield per Acre of Principal Crops in India for the period ending 1916-17. Price As. 12 or 1s. 2d.	Issued by the Department of Statistics, India.	Ditto.
11	Report on the Production of Tea in India in the Calendar Year 1918. Price As. 8.	Ditto	Ditto.
12	Estimates of Area and Yield of Principal Crops in India, 1918-19. Price As. 8.	Issued by the Department of Statistics, India.	Ditto.
13	Report on the Operations of the Department of Agriculture, Bengal, for the year 1918-19 (including Expert Officers' Reports). Price Rs. 2 or 3s.	Issued by the Department of Agriculture, Bengal.	Bengal Secretariat Press, Writers' Buildings, Calcutta.
14	Annual Reports of Expert Officers of the Department of Agriculture, Bengal, for the year 1917-18. Price Re. 1-12 or 2s. 6d.	Agricultural Department of Bengal.	Ditto.
15	Insect of Ganja, Bengal Department of Agriculture Bulletin No. 1 of 1919. Price A. 1.	Ditto	Ditto.
16	Annual Report of the Department of Agriculture, Bihar and Orissa, for 1918-19. Price As. 6 or 6d.	Issued by the Department of Agriculture, Bihar and Orissa.	Government Press, Bihar and Orissa, Patna.
17	Report on the Administration of the Department of Agriculture of the United Provinces for the year ending the 30th June, 1919. Price As. 8 or 1s.	Issued by the Department of Agriculture, United Provinces.	Government Press, United Provinces, Allahabad.
18	Report on the Agricultural Experiments in the Central Circle, United Provinces, for the year ending 30th June, 1919.	Ditto	Ditto.
19	Report on the Agricultural Stations of the Western Circle, United Provinces, for the year ending 30th June, 1919.	Ditto	Ditto.

LIST OF AGRICULTURAL PUBLICATIONS—*contd.*

No.	Title	Author	Where published
<i>General Agriculture—contd.</i>			
20	Combined Report of the Partabgarh and Benares Agricultural Stations of the United Provinces for the year ending 30th June, 1919.	Issued by the Department of Agriculture, United Provinces.	Government Press, United Provinces, Allahabad.
21	Annual Report of the Department of Agriculture, Punjab, for the year ending 30th June, 1919, Part I. Price As. 7.	Issued by the Department of Agriculture, Punjab.	Government Printing, Punjab, Lahore.
22	Annual Report of the Department of Agriculture, Punjab, for the year ending 30th June, 1919, Part II. Price Rs. 2-12 or 7s. 1d.	Ditto	Ditto.
23	Season and Crop Report of the Punjab for 1918-19. Price Re. 1 or 1s. 6d.	Ditto	Ditto.
24	Annual Report of the Lawrence Gardens, Lahore. Price As. 2.	Ditto	Ditto.
25	Prospectus of the Punjab Agricultural College, Lyallpur. (<i>Not for sale.</i>)	Ditto	Ditto.
26	Tables of the Agricultural Statistics of the Punjab for the year 1918-19.	Ditto	Ditto.
27	Annual Report of the Department of Agriculture, Bombay Presidency, for 1918-19. Price As. 14 or 1s. 9d.	Issued by the Department of Agriculture, Bombay.	Government Press, Central Bombay.
28	Season and Crop Report of the Bombay Presidency. Price As. 8 or 1s.	Ditto	Ditto.
29	Work on the Manjri Farm for 3 years 1915-18, Bombay Department of Agriculture Bulletin No. 90 of 1918. Price As. 7-3 p. or 9d.	J. B. Knight, Professor of Agriculture.	Ditto.
30	The Cultivation of Berseem in Sind Experiments at Sukkar. Bombay Department of Agriculture Bulletin No. 91. Price A. 1 or 1d.	Lokeram L. Relwani, L. Ag.	Ditto.
31	Classification and Description of the Jowars of the Bombay Karnatak. Bombay Department of Agriculture Bulletin No. 92 of 1919. Price As. 10 or 11d.	G. K. Kottur, B. Ag., Cotton Supervisor, Southern Division, Bombay Presidency.	Yeravda Prison Press, Poona.

LIST OF AGRICULTURAL PUBLICATIONS—*contd.*

No.	Title	Author	Where published
<i>General Agriculture—contd.</i>			
32	Report on the Operations of the Department of Agriculture, Madras Presidency, for 1918-19. Price As. 3 or 3d.	Issued by the Department of Agriculture, Madras.	Government Press, Madras.
33	A Soil Survey of the Kistna Delta. Madras Department of Agriculture Bulletin No. 75.	W. H. Harrison, D.Sc., M. R. Ramasami Sivan, B.A., Dip., Agri., and B. Visvanath.	Ditto.
34	Note on Tobacco Cultivation in Godavari Lankas.	Compiled from the experiences of T. H. Barry, Esq., of Cocanada.	Ditto.
35	Control of Important Paddy Pests.	M. R. Ry. D. Bala-krishna Moorthy.	Ditto.
36	Report on the Working of the Department of Agriculture, Central Provinces, for 1918-19. Price Re. 1 or 1s. 6d.	Issued by the Department of Agriculture, Central Provinces and Berar.	Government Press, Nagpur.
37	Report on the (1) Agricultural College, Nagpur, (2) Botanical and Chemical Research, and (3) Maharajbagh Menagerie. Price As. 8.	Ditto	Ditto.
38	Report on the Experimental Farm attached to the Agricultural College, Nagpur, for 1918-19. Price As. 8.	Ditto	Ditto.
39	Report on the Demonstration Work in Northern Circle for 1918-19. Price As. 8.	Ditto	Ditto
40	Farm Yard Manure. Central Provinces Department of Agriculture Bulletin No. III. Farm. Price As. 2.	R. G. Allan, M.A., Principal, Agricultural College, Nagpur.	Ditto.
41	Some Observations on the Cotton Cultivation. Central Provinces Department of Agriculture Bulletin No. IV. Price As. 2.	Ditto	Ditto.
42	Imported Ploughs and their Satisfactory Working. Central Provinces Department of Agriculture Bulletin No. V. Price As. 2.	Ditto	Ditto.
43	Oilcakes: Their Uses as Cattle Food and Manure. Central Provinces Department of Agriculture Bulletin No. VI. Price As. 2.	F. J. Plymen, Deputy Director of Agriculture, Western Circle.	Ditto.

LIST OF AGRICULTURAL PUBLICATIONS—*contd.*

No.	Title	Author	Where published
<i>General Agriculture—concl'd.</i>			
44	Weeds. Central Provinces Department of Agriculture Bulletin No. VII. Price As. 2.	R. G. Allan, M.A., Principal, Agricultural College, Nagpur.	Government Press Nagpur.
45	Annual Report of the Department of Agriculture, Assam, for the 9 months ending 31st March, 1919. Price As. 8 or 9d.	Issued by the Department of Agriculture, Assam.	The Assam Secretariat Printing Office, Shillong.
46	Report of the Agricultural Experiments and Demonstrations in Assam for 9 months ending 31st March, 1920.	Ditto	Ditto.
47	Report on the Operations of the Department of Agriculture, Burma, for the year ending 30th June, 1919. Price As. 8 or 1s.	Issued by the Department of Agriculture, Burma.	Government Printing Office, Burma, Rangoon.
48	Guinea Grass. Burma Department of Agriculture Leaflet No. 52.	A. McKerrel, Deputy Director of Agriculture, Southern Circle, Burma.	Ditto.
49	Summary of Remarks on the Kharif Crop of the North-West Frontier Province for 1919. Price As. 7 or 10d.	Revenue Commissioner, North-West Frontier Province.	N. W. F. P. Government Press, Peshawar.
50	<i>The Journal of the Madras Agricultural Students' Union</i> (monthly). Annual subscription Rs. 2.	Madras Agricultural Students' Union.	Literary Sun Press, Coimbatore.
51	<i>Quarterly Journal of the Indian Tea Association</i> . Price As. 6 per copy.	Scientific Department of the Indian Tea Association, Calcutta.	Catholic Orphan Press, Calcutta.
52	<i>The Journal of Dairying and Dairy-Farming in India</i> (quarterly). Subscription Rs. 5 per annum (including membership).	Published by the Indian Committee of the Dairy Education Association, Quetta.	Messrs. Thacker, Spink & Co., Calcutta.
53	<i>Poona Agricultural College Magazine</i> (quarterly). Annual subscription Rs. 2.	College Magazine Committee, Poona.	Arya Bhusan Press, Poona.
54	<i>Journal of the Mysore Agricultural and Experimental Union</i> (quarterly). Annual subscription Rs. 3.	Mysore Agricultural Experimental Union.	Bangalore Press, Bangalore.
55	<i>Indian Scientific Agriculturist</i> . Annual subscription Rs. 4.	Alliance Advertising Association Ltd., Calcutta.	Bera & Co., Printers, Calcutta.

LIST OF AGRICULTURAL PUBLICATIONS—*contd.*

No.	Title	Author	Where published
AGRICULTURAL CHEMISTRY			
56	The Phosphate Requirements of some Lower Burma Paddy Soils Memoirs of the Department of Agriculture in India, Chemical Series, Vol. V, No. 5. Price Re. 1-12 or 3s. 3d.	F. J. Warth, M.Sc., B.Sc., Agricultural Chemist to the Government of Burma, and Maung Po Shin, Assistant to the Agricultural Chemist to the Government of Burma.	Messrs. Thacker, Spink & Co., Calcutta.
57	Absorption of Lime by Soils. Memoirs of the Department of Agriculture in India, Chemical Series, Vol. V, No. 6. Price Re. 1-2 or 2s.	F. J. Warth, Agricultural Chemist to the Government of Burma, and Maung Po Saw, Assistant to the Agricultural Chemist to the Government of Burma.	Ditto.
58	Proceedings of the First Meeting of Agricultural Chemists and Bacteriologists held at Pusa on the 24th February, 1919, and the following days. Price Re. 1 or 1s. 6d.	Issued from the Agricultural Research Institute, Pusa.	Government Printing; India, Calcutta.
BOTANY			
59	Studies in Indian Sugarcane No. 5. On testing the suitability of sugarcane varieties for different localities by a system of measurements. Periodicity in the growth of the sugarcane. Memoirs of the Department of Agriculture in India, Botanical Series, Vol. X, No. 3. Price Re. 1-12 or 3s.	C. A. Barber, C.I.E., Sc.D., F.L.S., Government Sugarcane Expert, Madras.	Messrs. Thacker, Spink & Co., Calcutta.
MYCOLOGY.			
60	A Pythium Disease of Ginger, Tobacco and Papaya. Memoirs of the Department of Agriculture in India, Botanical Series, Vol. X, No. 4. Price Re. 1-8 or 2s. 6d.	L. S. Subramaniam, Assistant to the Imperial Mycologist, Pusa.	Messrs. Thacker, Spink & Co., Calcutta.
61	Proceedings of the Second Meeting of the Mycological Workers in India held at Pusa on the 24th March, 1919, and following days. Price As. 11 or 1s.	Issued from the Agricultural Research Institute, Pusa.	Government Printing, India, Calcutta.
ENTOMOLOGY			
62	A Contribution to our Knowledge of South Indian Coccidae, Pusa Agricultural Research Institute Bulletin No. 87. Price As. 14 or 1s. 3d.	T. V. Ramakrishna Ayyar, B.A., F.E.S., F.Z.S., Acting Government Entomologist, Madras.	Government Printing; India, Calcutta.

LIST OF AGRICULTURAL PUBLICATIONS—*contd.*

No.	Title	Author	Where published
<i>Entomology—concltd.</i>			
63	Second Hundred Notes on Indian Insects: Pusa Agricultural Research Institute Bulletin No. 89.	Compiled by Entomological Section, Pusa.	Ditto.
64	Rice Hispa. Madras Department of Agriculture Leaflet No. 1.	T. V. Ramakrishna Ayyar.	Government Press, Madras.
65	Hairy Caterpillar. Madras Department of Agriculture Leaflet No. 2.	T. V. Ramakrishna Ayyar.	Ditto.
VETERINARY			
66	Annual Report of the Imperial Bacteriological Laboratory, Muktesar, for the year ending 31st March, 1919. Price As. 4 or 5 <i>d.</i>	Director and First Bacteriologist, Imperial Bacteriological Laboratory, Muktesar.	Government Printing, India, Calcutta.
67	A Malarial Parasite in the Blood of a Buffalo. Pusa Agricultural Research Institute Bulletin No. 90. Price As. 6 or 7 <i>d.</i>	A. L. Sheather, B.Sc., M.R.C.V.S., Director and First Bacteriologist, Imperial Bacteriological Laboratory, Muktesar.	Ditto
68	Proceedings of the First Meeting of Veterinary Officers in India held at Lahore on the 24th March, 1919, and following days (with appendices). Price As. 8 or 9 <i>d.</i>	Issued from the Agricultural Research Institute, Pusa.	Ditto.
69	<i>Spygamus laryngens</i> in Cattle and Buffaloes in India. Pusa Research Institute Bulletin No. 92. Price As. 6.	A. L. Sheather, B.Sc., M.R.C.V.S., Director and First Bacteriologist, and A. W. Shilston, M.R.C.V.S., Second Imperial Bacteriologist, Imperial Bacteriological Laboratory, Muktesar.	Ditto.
70	Annual Report of the Civil Veterinary Department, Bihar & Orissa, for 1918-19.	Issued by the Department of Agriculture, Bihar & Orissa.	Government Press, Gularbagh, Patna.
71	Annual Report of the Punjab Veterinary College, Civil Veterinary Department, Punjab, and the Government Cattle Farm, Hissar, for the year 1918-19. Price As. 10 or 10 <i>d.</i>	Issued by the Department of Agriculture, Punjab.	Government Printing, Lahore.
72	Rinderpest. Madras Department of Agriculture Leaflet No. 4.	F. Ware, M.R.C.V.S., Superintendent, Civil Veterinary Department, Madras.	Government Press, Madras.

LIST OF AGRICULTURAL PUBLICATIONS—*conold.*

No.	Title	Author	Where published
<i>Veterinary—conold.</i>			
73	Annual Report of the Veterinary Department, Assam, for the year ending 31st March, 1919.	Issued by the Civil Veterinary Department, Assam.	Assam Secretariat Printing Office, Shilong.
74	Report of the Civil Veterinary Department, Burma, for the year ending 31st March, 1919. Price As. 12 or 1s. 1d.	Issued by the Civil Veterinary Department, Burma.	Government Printing, Burma, Rangoon.

PUBLICATIONS OF THE IMPERIAL DEPARTMENT OF AGRICULTURE IN INDIA

TO BE HAD FROM

THE OFFICE OF THE AGRICULTURAL ADVISER TO THE GOVERNMENT OF INDIA, PUSA, BIHAR,
and from the following Agents :—

- | | |
|--|---|
| (1) THACKER, SPINK & CO., CALCUTTA. | (7) THACKER & CO., LTD., BOMBAY. |
| (2) W. NEWMAN & CO., CALCUTTA. | (8) SUNDER PANDURANG, BOMBAY. |
| (3) RAI M. C. SARKAR BAHADUR & SONS, CALCUTTA. | (9) RAI SAHIB M. GULAB SINGH & SONS, LAHORE. |
| (4) HIGGINBOTHAMS, LTD., MADRAS. | (10) MANAGER, EDUCATIONAL BOOK DEPOT, NAGPUR. |
| (5) THOMPSON & CO., MADRAS. | |
| (6) D. B. TARAPOREVALA, SONS & CO., BOMBAY. | |

A complete list of the publications of the Imperial Department of Agriculture in India can be obtained on application from the Agricultural Adviser to the Government of India, Pusa, Bihar, or from any of the above-mentioned Agents.

These publications are :—

1. *The Agricultural Journal of India*. A Journal dealing with subjects connected with agricultural economics, field and garden crops, economic plants and fruits, soils, manures, methods of cultivation, irrigation, climatic conditions, insect pests, fungus diseases, co-operative credit, agricultural cattle, farm implements, and other agricultural matters in India. Illustrations, including coloured plates, form a prominent feature of the Journal. It is edited by the Agricultural Adviser to the Government of India, and is issued once every two months or six times a year. *Annual Subscription*, Rs. 6 or 9s. 6d., including postage. *Single copy*, R. 1-8 or 2s.
2. Scientific Reports of the Agricultural Research Institute, Pusa (including the Report of the Imperial Cotton Specialist).
3. Annual Report on the Progress of Agriculture in India.
4. Proceedings of the Board of Agriculture in India.
5. Proceedings of Sectional Meetings of the Board of Agriculture.
6. Memoirs of the Imperial Department of Agriculture in India :
 - (a) Botanical Series.
 - (b) Chemical Series.
 - (c) Entomological Series.
 - (d) Bacteriological Series.
 - (e) Veterinary Series.
7. Bulletins issued by the Agricultural Research Institute, Pusa.
8. Books.

The following are the publications of the last two years :—

- Scientific Reports of the Agricultural Research Institute and College, Pusa (including the Report of the Imperial Cotton Specialist), for the year 1917-18. Price, R. 1-4 or 2s.
- Scientific Reports of the Agricultural Research Institute, Pusa (including the Report of the Imperial Cotton Specialist), for the year 1918-19. Price, R. 1-4 or 2s.
- Report on the Progress of Agriculture in India for the year 1917-18. Price, R. 1-8 or 2s. 3d.
- Report on the Progress of Agriculture in India for the year 1918-19. Price, R. 1-4 or 2s.
- Proceedings of the Board of Agriculture in India, held at Pusa on the 1st December, 1919, and following days (with Appendices). Price, As. 12 or 1s. 3d.

AGRICULTURAL PUBLICATIONS.—(Concl'd.)

- Proceedings of the Second Meeting of Mycological Workers in India, held at Pusa on the 20th February, 1919, and following days. Price, As. 11 or 1s.
- Proceedings of the First Meeting of Agricultural Chemists and Bacteriologists, held at Pusa on 24th February, 1919, and the following days. Price, R. 1 or 1s. 6d.
- Proceedings of the First Meeting of Veterinary Officers in India, held at Lahore on the 24th March, 1919, and following days (with Appendices). Price, As. 8 or 9d.
- Proceedings of the Third Entomological Meeting held at Pusa in February, 1919. (*In the press.*)

MEMOIRS OF THE DEPARTMENT OF AGRICULTURE IN INDIA

BOTANICAL SERIES

- Vol. IX, No. IV. Studies in Indian Sugarcanes. No. 3. The Classification of Indian Canes with special reference to the Saretha and Sunnabile Groups, by C. A. BARBER, sc.D. Price, Rs. 2-4 or 3s.
- Vol. IX, No. V. *Phytophthora Meadii* n. sp. on *Hevea brasiliensis*, by W. McRAE, M.A., B.Sc., F.L.S. Price, R. 1-4 or 2s.
- Vol. X, No. I. The Rice Worm (*Tylenchus angustus*) and its Control, by E. J. BUTLER, M.B., F.L.S. Price, R. 1-4 or 2s.
- Vol. X, No. II. Studies in Indian Sugarcanes, No. 4. Tillering or Underground Branching, by C. A. BARBER, C.I.E., sc.D., F.L.S. Price, Rs. 4-4 or 7s.
- Vol. X, No. III. Studies in Indian Sugarcanes, No. 5. On testing the suitability of sugarcane varieties for different localities, by a system of measurements. Periodicity in the growth of the sugarcane, by C. A. BARBER, C.I.E., sc.D., F.L.S. Price, R. 1-12 or 3s.
- Vol. X, No. IV. A *Pythium* Disease of Ginger, Tobacco and Papaya, by L. S. Subramaniam. Price, R. 1-8 or 2s. 6d.
- Vol. X, No. V. Studies in the Pollination of Indian Crops, 1, by A. HOWARD, GABRIELLE L. C. HOWARD, and ABDUR RAHMAN KHAN. Price, R. 1-4 or 2s. 6d.
- Vol. X, No. VI. "Kumpta" Cotton and its Improvement, by G. L. KOTTUR, B. Ag. (*In the press.*)
- Vol. XI, No. I. Some Aspects of the Indigo Industry in Bihar. Part I. The Wilt Disease of Indigo. Part II. The factors underlying the seed production and growth of Java Indigo, by ALBERT HOWARD, C.I.E., M.A., and GABRIELLE L. C. HOWARD, M.A., with the assistance of CHOWDHURY RAMDHAN SINGH and MAULVI ABDUR RAHMAN KHAN. (*In the press.*)
- Vol. XI, No. II. Studies in Diseases of the Jute Plant. (1) *Diplodia Corchori*, Syd., by F. J. F. SHAW, D.Sc., A.R.C.S., F.L.S. (*In the press.*)

CHEMICAL SERIES

- Vol. V, No. II. "Heart Damage" in Baled Jute, by R. S. FINLOW, B.Sc., F.I.C., F.C.S. Price, R. 1 or 1s. 6d.
- Vol. V, No. III. Experiments on the Improvement of the Date Palm Sugar Industry in Bengal, by HAROLD E. ANNETT, B.Sc., F.I.C.; GOSTA BEHARI PAL, M.Sc. and INDU BHUSHAN CHATTERJEE, L.Ag. Price, R. 1 or 1s. 6d.
- Vol. V, No. IV. Cholam (*A. Sorghum*) as a Substitute for Barley in Malting Operations, by B. VISWANATH, T. LAKSHMANA ROW, B.A., and P. A. RAGHUNATHASWAMI AYYANGAR, Dip. Ag. Price, As. 12 or 1s.
- Vol. V, No. V. The Phosphate Requirements of some Lower Burma Paddy Soils, by F. J. WARTH, M.Sc., B.Sc., and Maung Po Shin. Price, R. 1-12 or 3s. 3d.
- Vol. V, No. VI. Absorption of Lime by Soils, by F. J. WARTH, M.Sc., B.Sc., and MAUNG PO SAW. Price, R. 1-2 or 2s.

ENTOMOLOGICAL SERIES

- Vol. V, No. V. The Rice Leaf-hoppers (*Nephotettix bipunctatus*, Fabr. and *Nephotettix apicalis*, Motsch.), by C. S. MISRA, B.A. (*In the press.*)
- Vol. V, No. VI. *Lantana* Insects in India. Being the Report of an Inquiry into the Efficiency of Indigenous Insect Pests as a Check on the Spread of *Lantana* in India, by Y. RAMACHANDRA RAO, M.A., F.E.S. (*In the press.*)

ENTOMOLOGICAL SERIES.—(Concl'd.)

- Vol. VI. Life-histories of Indian Insects: Microlepidoptera, by T. BAINBRIDGE FLETCHER, B.N., F.L.S., F.E.S., F.Z.S., Imperial Entomologist. (*In the press.*)
- „ No. I. Pterophoridae.
- „ No. II. Carposinidae, Phalonidae, Tortricidae and Eucosmidae.
- „ No. III. Gelechiidae.
- „ No. IV. Cosmopterygidae, (Ecophoridae, Physoptilidae, Xyloryctidae, Stenonidae and Orneodidae).
- „ No. V. Heliozelidae. Heliodinidae. Glyphipterygidae, Blastobasidae and Hyponomeutidae.
- „ No. VI. Gracillariidae.
- „ No. VII. Epermeniidae, Plutellidae and Lyonetiidae.
- „ No. VIII. Tineidae and Nepticulidae.
- Vol. VII, Nos. 1 & 2. New Indian Gall Midges (Diptera), by E. P. FELT, State Entomologist of New York, U. S. A.; and Description of a Phinocyphus larva from Shillong, by MAJOR F. C. FRASER, I.M.S.

BACTERIOLOGICAL SERIES

- Vol. I, No. VII. A Bacterial Disease of Wheat in the Punjab, by C. M. HUTCHINSON, B.A. Price, As. 12 or 1s.
- Vol. I, No. VIII. Pebrine in India, by C. M. HUTCHINSON, B.A. (*In the press.*)
- Vol. I, No. IX. Studies on the Root Nodule Organism of the Leguminous Plants, by N. V. JOSHI, M.Sc., B.A., L. Ag. (*In the press.*)

VETERINARY SERIES

- Vol. II, No. VIII. *Kumfi*: Combined Diffuse Sclerosis and Central Poliomyelitis of Horses, by G. H. K. MACALISTER, M.A., M.D., D.P.H. Price, R. 1-8 or 2s. 6d.
- Vol. III, No. I. The Vitality of the Rinderpest Virus outside the Animal Body under Natural Conditions, by A. W. SHILTON, M.R.C.V.S. Price, As. 12 or 1s.

BULLETINS ISSUED BY THE AGRICULTURAL RESEARCH INSTITUTE, PUSA

- No. 77. Some Camel-feeding Experiments, by H. E. CROSS, M.R.C.V.S., D.V.H., A.Sc. Price, As. 2 or 3d.
- No. 78. Smuts of Jowar (*Sorghum*) in the Bombay Presidency, by G. S. KULKARNI, L.Ag. Price, As. 4 or 5d.
- No. 79. Prussic Acid in Burma Beans, by F. J. WARTH, B.Sc., M.Sc.; and KO KO GYI. Price, As. 2 or 3d.
- No. 80. Are Camels Susceptible to Black Quarter, Hæmorrhagic Septicæmia and Rinderpest, by H. E. CROSS, M.R.C.V.S., D.V.H., A.Sc. Price, As. 4 or 5d.
- No. 81. The Value of Phosphatic Manures in India and the Possibility of their Manufacture on a Larger Scale. Being evidence submitted to the Committee appointed to discuss this question (Subject IX) at the Meeting of the Board of Agriculture, Poona, 1917. Edited, with an Introduction, by W. A. DAVIS, B.Sc., A.C.G.I. Price, As. 4 or 5d.
- No. 82. The Improvement of the Indigenous Methods of *Gur* and Sugar making in the United Provinces, by WILLIAM HULME and R. P. SANGHI. Price, As. 8 or 9d.
- No. 83. Progress of the Sugarcane Industry in India during the Years 1916 and 1917. Being Notes submitted to the Meeting of the Board of Agriculture in India, Poona, 1917. Edited, with an Introduction, by C. A. BARBER, C.I.E., Sc.D., F.L.S. Price, As. 5 or 6d.
- No. 84. The Best Means of Rapidly Increasing the Outturns of Food Crops by Methods within the Power of the Agricultural Department. Being Notes submitted to the Meeting of the Board of Agriculture in India, Poona, 1917. Edited, with an Introduction, by J. MACKENNA, C.I.E., I.C.S. Price, As. 4 or 5d.
- No. 85. Soil Drainage, by R. G. ALLAN, M.A. Price, As. 4 or 5d.
- No. 86. A New Nematode causing Parasitic Gastritis in Calves, by A. L. SHEATHER, B.Sc., M.R.C.V.S. Price, As. 4 or 5d.

BULLETINS ISSUED BY THE AGRICULTURAL RESEARCH INSTITUTE, PUSA—(Concl'd.)

- No. 87. A Contribution to our Knowledge of South Indian Coccidæ, by T. V. RAMAKRISHNA AYYAR, B.A., F.E.S., F.Z.S. Price, As. 14 or 1s. 6d.
- No. 88. Cawnpore-American Cotton: An Account of Experiments in its Improvement by Pure Line Selection and of Field Trials, 1913-1917, by B. C. BURT, B.Sc., and NIZAMUDDIN HAIDER. Price, As. 10 or 1s.
- No. 89. Second Hundred Notes on Indian Insects. Price, R. 1-4 or 2s.
- No. 90. A Malarial Parasite in the Blood of a Buffalo, by A. L. SHEATHER, B.Sc., M.R.C.V.S. Price, As. 8 or 7d.
- No. 91. Notes on Practical Salt Land Reclamation, by G. S. HENDERSON, N.D.A., N.D.D. Price, As. 6.
- No. 92. *Syngamus laryngeus* in Cattle and Buffaloes in India, by A. LESLIE SHEATHER, B.Sc., M.R.C.V.S., and A. W. SHILSTON, M.R.C.V.S. Price, As. 6.
- No. 93. The Orange: The Trial of Stocks at Peshawar, by W. ROBERTSON BROWN. (*In the press.*)
- No. 94. A Preliminary Note on the Behaviour in North India of the first batch of Sugarcane Seedlings raised at the Sugarcane-breeding Station, Coimbatore, by T. S. VENKATRAMAN, B.A. Price, As. 8.
- No. 95. A Note on the Treatment of Surra in Camels by Intravenous Injections of Tartar Emetic, by H. E. CROSS, M.R.C.V.S., D.V.H., A.Sc. (*In the press.*)

INDIGO PUBLICATIONS

- No. 1. A Study of the Indigo Soils of Bihar. The Urgent Necessity for Immediate Phosphate Manuring if Crops are to be Maintained, by W. A. DAVIS, B.Sc., A.C.G.I. Price, R. 1-4 or 2s.
- No. 2. Present Position and Future Prospects of the Natural Indigo Industry, by W. A. DAVIS, B.Sc., A.C.G.I. Price, As. 10 or 1s.
- No. 3. The Loss of Indigo caused by Bad Settling and the means of obviating this. The use of Dhak Gum—its Effect on Yield and Quality, by W. A. DAVIS, B.Sc., A.C.G.I. Price, As. 4 or 5d.
- No. 4. The Future Prospects of the Natural Indigo Industry: The Effect of Superphosphate Manuring on the Yield and Quality of the Indigo Plant, by W. A. DAVIS, B.Sc., A.C.G.I. Price, As. 4 or 5d.
- No. 5. An Improved Method of preparing Indican from Indigo-yielding Plants, by BHAILAL M. AMIN, B.A. Price, As. 2 or 3d.
- No. 6. The Effect of Manuring with Superphosphate and Sannai on the Yield of Crops on Indigo Planters' Estates in Bihar—especially of Rabi Crops in the Season 1918-1919, by W. A. DAVIS, B.Sc., A.C.G.I. (*In the press.*)

BOOKS

- "Indian Insect Pests," by H. MAXWELL-LEFROY, M.A., F.E.S., F.Z.S. Price, R. 1-8 or 2s (*Out of print.*)
- "Indian Insect Life," by H. MAXWELL-LEFROY, M.A., F.E.S., F.Z.S.; and F. M. HOWLETT, B.A. 786 pp. Price, Rs. 20 or 30s. (*Out of print.*)
- "Wheat in India," by ALBERT HOWARD, M.A., A.R.C.S., F.L.S.; and GABRIELLE L. C. HOWARD, M.A. 288 pp. Price, Rs. 5 or 7s. 6d.
- "A Description of the Imperial Bacteriological Laboratory, Muktesar: Its Work and Products," by Major J. D. E. HOLMES, M.A., D.Sc., M.R.C.V.S. Price, As. 8 or 9d.
- "Agriculture in India," by JAMES MACKENNA, M.A., I.C.S. Price, As. 4 or 5d.
- "Some Diseases of Cattle in India. A Handbook for Stock-owners." Price, As. 8 or 9d.
- "The Importance of Bacterial Action in Indigo Manufacture," by C. M. HUTCHINSON, B.A. Price, As. 2 or 3d.
- "Report of the Proceedings of the Second Entomological Meeting, held at Pusa on the 5th-12th February, 1917." Price, Rs. 3.

Report of the Indian Cotton Committee. Vol. I, Report; Vol. II, Maps and Plans. Price R. 1 per volume. (Superintendent: Government Printing, India, Calcutta.)

VOL. XV, PART IV

July, 1920

THE AGRICULTURAL JOURNAL OF INDIA



EDITED BY

The Agricultural Adviser to the Government of India

PUBLISHED FOR

THE IMPERIAL DEPARTMENT OF AGRICULTURE IN INDIA

BY

THACKER, SPINK & CO., CALCUTTA

W. THACKER & CO., 2, CREED LANE, LONDON

Price R. 1-8 or Two Shillings

Agents for the Sale of Government Publications

IN EUROPE

- Constable & Co., 10, Orange Street, Leicester Square, London, W.C.
Kegan Paul, Trench Trübner & Co., 68-74, Carter Lane, E.C., and 25, Museum Street, London, W.C.
Bernard Quaritch, 11, Grafton Street, New Bond Street, London, W.
P. S. King & Sons, 2 & 4, Great Smith Street, Westminster, London, S.W.
H. S. King & Co., 65, Cornhill, E.C., and 9, Pall Mall, London, W.
Grindlay & Co., 54, Parliament Street, London, S.W.
Luzac & Co., 46, Great Russell Street, London, W.C.
W. Thacker & Co., 2, Creed Lane, London, E.C.
T. Fisher Unwin, Limited, 1, Adelphi Terrace, London, W.C.
B. H. Blackwell, 50 & 51, Broad Street, Oxford.
Deighton, Bell & Co., Ltd., Cambridge.
Oliver & Boyd, Tweeddale Court, Edinburgh.
E. Ponsonby, Ltd., 116, Grafton Street, Dublin.
Ernest Leroux, 28, Rue Bonaparte, Paris.
Martinus Nijhoff, The Hague, Holland.

IN INDIA AND CEYLON

- Thacker, Spink & Co., Calcutta and Simla.
W. Newman & Co., Calcutta.
R. Cambay & Co., Calcutta.
S. K. Lahiri & Co., Calcutta.
B. Bannerjee & Co., Calcutta.
The Indian School Supply Depôt, 309, Bow Bazar Street, Calcutta, and 226, Nawabpur, Dacca.
Butterworth & Co. (India), Ltd., Calcutta.
Rai M. C. Sarkar Bahadur & Sons, 75-1-1, Harrison Road, Calcutta.
The Weldon Library, 18-5, Chowringhee Road, Calcutta.
Standard Literature Co., Ltd., Calcutta.
Lal Chand & Sons, Calcutta.
Higginbothams, Ltd., Madras.
V. Kaliyanarama Iyer & Co., Madras.
G. A. Natesan & Co., Madras.
S. Murthy & Co., Madras.
Thompson & Co., Madras.
Temple & Co., Madras.
P. R. Rama Iyer & Co., Madras.
E. M. Gopalakrishna Kone, Madura.
Thacker & Co., Ltd., Bombay.
A. J. Cambridge & Co., Bombay.
D. B. Taraporevala, Sons & Co., Bombay.
Mrs. Radhabai Atmaram Sagoon, Bombay.
Sunder Pandurang, Bombay.
Gopal Narayan & Co., Bombay.
Ramchandra Govind & Son, Kalbadevi, Bombay.
A. H. Wheeler & Co., Allahabad, Calcutta, and Bombay.
N. B. Mathur, Superintendent, Nazir Kanun-i-Hind Press, Allahabad.
Rai Sahib M. Gulab Singh & Sons, Mufid-i-Am Press, Lahore.
A. Chand & Co., Lahore, Punjab.
Ram Krishna & Sons, Lahore.
Superintendent, American Baptist Mission Press, Rangoon.
Manager, the "Hitavada," Nagpur.
S. C. Talukdar, Proprietor, Students & Co., Cooch Behar.
A. M. & J. Ferguson, Colombo, Ceylon.
Manager, Educational Book Depôts, Nagpur and Jubbulpore.*
Manager of the Imperial Book Depôt, 63, Chandney Chauk Street, Delhi.*
Manager, "The Agra Medical Hall and Co-operative Association, Ltd." (Successors to A. John & Co., Agra.)*
Superintendent, Basel Mission Book and Tract Depository, Mangalore.*
P. Varadachary & Co., Madras.*
H. Liddell, Printer, etc., 7, South Road, Allahabad.*
D. C. Anand & Sons, Peshawar.*
Ram Dayal Agarwala, 184, Katra, Allahabad.*
Manager, Newal Kishore Press, Lucknow.*

* Agents for the sale of Legislative Department Publications only.

CONTENTS

(VOL. XV, PART IV.)

ORIGINAL ARTICLES

	PAGE
SOME COMMON INDIAN BIRDS. No. 4—THE CATTLE EGRET (<i>Bubulcus coromandus</i>)	<i>T. Bainbrigg Fletcher, R.N., F.L.S., F.E.S., F.Z.S.; and C. M. Inglis, M.B.O.U., F.Z.S.</i> 373
MR. J. MACKENNA, M.A., C.I.E., I.C.S.	<i>E. J. Butler, D.Sc., M.B., F.L.S.</i> 376
PRINCIPAL FODDERS IN THE CENTRAL PRO- VINCES AND BERAR, INCLUDING THE SMALL BAMBOO (<i>Dendrocalamus strictus</i>)	<i>D. Clouston, C.I.E.; and F. J. Plymen, A.C.G.I.</i> 380
SOME FACTS AND FIGURES REGARDING BANANA CULTIVATION	<i>W. Burns, D.Sc.; and P. G. Dani, B.Ag.</i> 386
SOME NOTES ON COTTON IN SIND	<i>K. I. Thadani, B.Ag.</i> 393
STUDIES IN BIOLOGICAL DECOMPOSITION OF COW-DUNG AND URINE IN SOIL	<i>N. V. Joshi, B.A., M.Sc., L.Ag.</i> 398
COMPARISON OF SALT LANDS IN THE DECCAN AND IN SIND	<i>V. A. Tamhane, M.Sc., L.Ag.</i> 410
HABIT IN SUGARCANES	<i>U. Vittal Rao, L.Ag.</i> 418

SELECTED ARTICLES

THE GROWTH OF THE SUGARCANE, III	425
NOTE ON THE EXHAUSTION OF INDIAN SOILS AND THE METHODS BY WHICH THIS MAY BE REMEDIED	433
THE POSSIBILITIES OF <i>Citrus</i> CULTURE IN INDIA	444
BRITISH CROP PRODUCTION	451

NOTES

PAGE

CONTRIBUTIONS FOR AGRICULTURAL INVESTIGATIONS	460
ORIENTATION OF BANANA INFLORESCENCE	461
A NOTE ON <i>Heliothis (Chloridea) obsoleta</i> , Fb., AS A PEST OF COTTON ..	462
PLANT HYGIENE	464
NEW SOURCE OF ALCOHOL	466
SUGAR FROM THE DOUGLAS FIR	467

PERSONAL NOTES, APPOINTMENTS AND TRANSFERS, MEETINGS AND CONFERENCES, ETC.	468
---	------------

REVIEWS

NOTES ON IMPROVED METHODS OF CANE CULTIVATION	474
AGRICULTURAL STATISTICS OF INDIA, 1917-18, VOL. I	476

NEW BOOKS ON AGRICULTURE AND ALLIED SUBJECTS	478
---	------------

LIST OF ILLUSTRATIONS

The Cattle Egret (<i>Bubulcus coromandus</i>)	Frontispiece.
	Facing page
Plate XIX. Mr. James Mackenna, M.A., C.I.E., I.C.S. ..	376
„ XX. The Indian Sugar Committee	378
„ XXI. Growth of bamboos and feeding of cattle with their leaves	383
„ XXII. Sugarcane buds planted in a tile plot with a lateral hole, and the instrument for measuring the angle of the main shoot	420
„ XXIII. Group of sugarcanes showing their habit	422
„ XXIV. ditto ditto	423
„ XXV. ditto ditto	424

Besides, there are nine charts accompanying Mr. Joshi's paper and two accompanying Mr. Vittal Rao's paper.

*The following Original Articles will appear in our next issue
(September 1920).*

- SOME COMMON INDIAN BIRDS. NO. 5—THE
GOLDEN-BACKED WOODPECKER (*Brachy-
pternus aurantius*) *T. Bainbrigge Fletcher,
R.N., F.L.S., F.E.S.,
F.Z.S.; and C. M.
Inglis, M.B.O.U.,
F.Z.S.*
- THE TOP-WORKING OF INDIAN FRUIT TREES . *W. Burns, D.Sc.; and
P. G. Joshi.*
- THE EXCRETION OF TOXINS FROM THE ROOTS
OF PLANTS *J. N. Mukherjee, B.A.,
B.Sc.*
- IMPROVED FURNACES FOR *Gur* MANUFACTURE . *G. K. Kelkar, B.Ag.*
- THE INFLUENCE OF STOCK AND SCION AND
THEIR RELATION TO ONE ANOTHER . *S. H. Prayag, M.Ag.*
- A PRELIMINARY NOTE ON THE IMPROVEMENT
OF ORANGES *K. P. Srivastava.*
- Gur*-MAKING FROM THE JUICE OF THE DATE-
PALM *V. G. Patwardhan, B.Ag.,
B.Sc.*



THE CATTLE EGRET *BUBULCUS COROMANDUS*.

Original Articles

SOME COMMON INDIAN BIRDS.

No. 4. THE CATTLE EGRET (*BUBULCUS COROMANDUS*).

BY

T. BAINBRIGGE FLETCHER, R.N., F.L.S., F.E.S., F.Z.S.,
Imperial Entomologist ;

AND

C. M. INGLIS, M.B.O.U., F.Z.S.

MOST of the birds dealt with in these articles are of general occurrence and as likely to be found in Calcutta, or any other large town, as in the surrounding country-side, but the subject of our present paper seems to have little use for a town life, although it is one of the "common objects of the country" in most parts of the *mofussil*. According to Stuart Baker, in North Cachar it ascends the hills to 2,200 feet. The Cattle Egret (*Bubulcus coromandus*), as its popular name implies, is an Egret which is especially attached to cattle—frequently accompanying these animals and feeding on the grasshoppers and other insects disturbed as the cattle move about and also picking off insects, ticks and leeches which are attracted to the cattle. It is a very tame bird, even coming into compounds where any cattle are grazing. It is a social bird, generally occurring in parties, accompanying the cattle in the fields and frequently perching on their backs. Sometimes it attends pigs also and relieves them of lice. Occasionally it accompanies

crocodiles and apparently picks leeches or other parasites off them, and sometimes it varies its diet with small fish, tadpoles and aquatic insects. The late C. W. Mason investigated the stomach contents of three birds at Pusa in December 1909 and found that they contained 166 insects, of which three were Carabid beetles which were classed as beneficial, three as neutral, and 160 as injurious, the majority of this last category comprising grasshoppers and flies. There is no doubt but that this bird is decidedly beneficial to the agriculturist in India, not only helping to keep down grasshoppers and other crop-pests, but reducing the numbers of blood-sucking pests which prey upon cattle.

The Cattle Egret is easily recognizable, being a pure white bird with a yellow bill and black legs during most of the year. In the breeding season, which is at the beginning of the rains, some hair-like yellowish plumes grow from the head, neck and back, as seen in the right-hand figure of our Plate ; these nuptial plumes are orange-coloured on the head and neck, those on the back orange-buff varying to pinkish or brownish buff. In Bihar this plumage is assumed in April, but in the case of one colony which was breeding on some mango trees in August there were just as many birds in the pure white as in the usual breeding plumage.

Before legislation took place this Egret suffered the same fate as those with more valuable plumes, but now it appears to be much less molested. It is protected by law throughout the whole year in the Central Provinces, Bombay, Bihar and Orissa, United Provinces, Delhi, Madras, Burma, and Assam.

As noted above, the Cattle Egret is a social bird at normal times, contrary to the habit of most herons during the non-breeding season, and it is probable that this social trait is the direct result of its attendance upon cattle. At the breeding season, however, which is from June to August in regions watered by the South-West monsoon, November and December in the Carnatic, and April and May in Ceylon, this sociability is greatly accentuated and the Cattle Egret at this time breeds together in vast numbers, often in company with other Egrets, Pond Herons and similar marsh-loving birds, making a large untidy nest of sticks, built in a tree,

often in tamarind trees around village ponds, and laying three to five very pale greenish or bluish eggs, almost white, which vary much in size and shape but are typically rather broad ovals, somewhat pointed towards one end, and measuring on the average about 43 mm. long by 33 mm. broad.

MR. J. MACKENNA, M.A., C.I.E., I.C.S.

BY

E. J. BUTLER, D.Sc., M.B., F.L.S.

ON the 30th of April, 1920, Mr. J. MACKENNA, M.A., C.I.E., I.C.S., vacated our editorial chair on his resignation of the post of Agricultural Adviser to the Government of India and Director of the Agricultural Research Institute, Pusa. By his resignation the "Agricultural Journal" has suffered a severe loss, and the Department has to regret the departure of a most distinguished and popular chief.

In his new appointment as Development Commissioner in Burma, he has taken up the highly responsible duties of the first post of the kind established in India, and it is gratifying to know that he will still remain in charge of the agricultural development of a considerable province of the Empire.

Mr. Mackenna's connection with the Agricultural Department extended over a period of 16 years from his first appointment as Director of Land Records and Agriculture, Burma, in 1904. Shortly after this, he attended the first meeting of the Board of Agriculture held at Pusa, in 1905, and, by his active participation in the discussions at this and subsequent meetings—he has attended nine of the eleven hitherto held and presided over three—has taken no small part in shaping the policy of the Department.

In Burma he was responsible for organising the Provincial Department of Agriculture which came into existence as a result of the policy of agricultural development initiated by Lord Curzon's Government in 1905. The first experts that started work on the



Photo by S. C. Ghosal,
Agricultural Research Institute, Pusa.

JAMES MACKENNA, M. A., C. I. E., I. C. S.,
Agricultural Adviser to the Government of India and ex-officio Editor,
"Agricultural Journal of India,"
1913-14 and 1916-20.

improvement of Burmese agriculture, with the advantage of Western experience, did so under his control, and it is fitting that, now that a large increase in expert staff of Burma has been sanctioned and a second period of progress is in sight, he should be back in his old province to exercise a guiding influence over the development of its resources.

He was first called to the charge of the Imperial Department of Agriculture in 1913, when he acted as Agricultural Adviser for a year during the absence of Mr. Coventry on leave. He returned to assume substantive charge when Mr. Coventry retired in 1916, and he held the post until his recent resignation, except for a short period of a month in 1918 when he acted as Secretary to the Government of India in the Department of Revenue and Agriculture, and for six months last year when he was on leave.

This period was one of exceptional strain in the agricultural as in all other departments. During the worst years of the war and the subsequent period of stagnation and slow recovery, the staff was depleted down to the bare minimum required to prevent disorganization. That in the face of these difficulties progress has not ceased is in no little degree due to the optimism with which Mr. Mackenna continued to consolidate the position already gained and prepare for a further advance as soon as conditions again became favourable. It was impossible to hope to expand during those years, but it was possible to prepare for accelerated progress in the brighter times that were coming. The end of the war found him with plans matured or maturing for a large expansion of activities in almost every direction and he had the satisfaction of placing these before Government during the past few months.

Post-war problems of great magnitude have to be faced in connection with some of our most important crops. The war very forcibly demonstrated the disadvantages of being dependent on foreign countries for supplies of the necessaries of life. Cotton and sugar are two of those commodities that the Empire produces in quantity insufficient for its needs, and in both cases India offers one of the most promising fields for development. Mr. Mackenna was instrumental in getting two strong committees appointed to

examine the Indian possibilities of expansion as regards these crops, and as President, first of the Indian Cotton Committee and then of the Indian Sugar Committee, he has spent a considerable part of the last three years in dealing with this question.

The Cotton Committee reported in 1918, and its recommendations have received a strong measure of support from bodies such as the Empire Cotton Growing Committee and the British Cotton Growers Association, as well as from the trade and agricultural authorities in India. They are far-reaching and will take a considerable time to give complete effect to, especially in the matter of securing the necessary staff to carry them out, but they are generally accepted as likely to be effective in improving the quantity and quality of the cotton grown in India.

The Sugar Committee was still sitting when Mr. Mackenna was summoned to Burma, and he had, therefore, to hand over its presidency to Mr. Noyce. Much of the Indian part of the enquiry was then completed and the evidence obtained is amply sufficient to show the need there was for a thorough examination of the position. Though India is one of the two chief producers in the world, there is little doubt that, but for the war, her imports of sugar would be now in excess of a million tons a year, and she is thus far from being in a position to feed herself, much less any other part of the Empire. But, with an area of some three million acres under the crop, it is clear that, if the Committee's recommendations are effective in stimulating the improvement of the present wretchedly low yield per acre, its work will have been of first-rate importance.

Another matter to which Mr. Mackenna devoted much attention was improving the publications of the Department. The "Journal" has greatly increased in popularity under his editorship and the recent decision to issue it every two months, instead of every quarter, should still further stimulate its circulation. His annual report on the Progress of Agriculture in India was regarded as, in many respects, a model for similar Government publications and was deservedly popular. In this connection, reference may also be made to his brochure on "Agriculture in India," where, in a



THE INDIAN SUGAR COMMITTEE.

FROM LEFT TO RIGHT, SEATED:—Mr. B. J. Padshah; Mr. F. Noyce, C. B. E., I. C. S., Vice-President (now President in succession to Mr. Mackenna); Mr. J. Mackenna, C. I. E., I. C. S., President; Mr. J. W. Macdonald; Sirdar Jogendra Singh.
FROM LEFT TO RIGHT, STANDING:—Sir Frank Carter, Kt., C. I. E., C. B. E.; Mr. A. E. Gilliat, I. C. S., (Secretary); Mr. M. Wynne Sayer; Mr. W. W. Craib.

little over a hundred pages, he gives a lucid and interesting account of the work of the agricultural and allied departments up to 1915.

At Pusa, Mr. Mackenna will long be remembered as the most genial and kindly of chiefs. He did much to improve the amenities of life, always difficult in such an isolated place, and showed a practical interest in regard to recreational, medical and educational facilities for the staff.

For the Indian Agricultural Service he worked hard to secure the revision of the terms of service that he held were long overdue. Though he was not himself a member of the Service, he had its interests at heart, and it owes a great deal to his representations on behalf of its members.

We hope that he will not forget his old friends in the Agricultural Department as we know they will not forget him. There may still be opportunities for an occasional meeting and we foresee a further increase in the popularity of Burma as a scene for the touring activities of the Pusa staff. The best wishes of the Department accompany Mr. and Mrs. Mackenna to Burma, where, we hope, they will have a very successful and happy time.

**PRINCIPAL FODDERS IN THE CENTRAL
PROVINCES AND BERAR, INCLUDING
THE SMALL BAMBOO (*DENDROCALAMUS
STRICTUS*).***

BY

D. CLOUSTON, C.I.E. AND F. J. PLYMEN, A.C.G.I.,

(Of the Department of Agriculture, Central Provinces and Berar.)

THE improvement in the breeding of Indian cattle in order to raise the standard of animal at the disposal of the Indian agriculturist involves also improvement in animal management, particularly as regards feeding. Stall-feeding is not only becoming possible but also necessary in some tracts; and in future the farmer will have to provide fodder for his cattle instead of depending upon indiscriminate grazing.

A series of analyses of the common grasses of the Central Provinces and Berar made in the department's laboratory some time ago showed that these grasses are fundamentally low in feeding value. The analyses are sufficiently interesting to be worth quoting.

Composition of common grasses of the Central Provinces and Berar.

Name of grass	Moisture	Oil, etc.	Total nitrogen protein*	Soluble carbo-hydrate	Crude fibre	Ash†	*Including true protein	†Including sand
<i>Ischæmum sulcatum</i> ..	7.38	1.38	3.56	35.75	35.35	16.58	3.19	14.59
<i>Apluda varia</i> ..	7.69	1.82	3.31	40.36	35.52	11.30	2.86	9.39
<i>Setaria glauca</i> ..	7.68	1.75	4.41	43.14	30.02	13.00	3.29	10.16
<i>Iscilemu laxum</i> ..	1.16	1.25	2.89	46.98	31.13	10.59	2.41	8.30
<i>Andropogon annulatus</i> ..	10.34	1.76	2.69	43.57	33.18	8.46	2.00	5.33
" <i>caricosus</i> ..	7.80	1.63	3.89	45.77	32.10	8.81	3.17	5.43
" <i>perthusus</i> ..	10.57	1.83	3.95	47.48	28.62	7.55	2.39	3.93
<i>Ischæmum laxum</i> ..	8.84	1.20	2.97	42.82	34.01	10.16	2.35	8.06
<i>Andropogon contortus</i> ..	6.67	1.06	2.00	50.13	32.91	7.23	1.76	5.02
AVERAGE ..	8.24	1.52	3.30	44.00	32.54	10.41	2.60	7.80

* Paper read at the Seventh Indian Science Congress, Nagpur, 1920.

For purposes of comparison the following analyses of grasses grown in more temperate climates are given. The figures have been collected from various reliable sources.

	Ether extract	Total nitrogen as protein	Nitrogen free extract and soluble carbohydrate	Crude fibre	Ash
United States	3.14	9.21	53.97	25.71	7.97
Germany	2.34	10.74	46.53	34.09	6.30
Queensland	1.93	13.39	49.73	22.53	12.42
New South Wales ..	2.14	9.03	52.81	29.35	6.67

It is clear from a consideration of these figures that in so far as chemical analysis is a guide, the feeding value of Central Provinces and Berar grasses is much below that of the grasses produced in the countries named, particularly with regard to the highly important protein matter. Some of the local grasses have, however, a distinct reputation for feeding purposes, *Ischaemum sulcatum* being sufficient in itself to keep horses and cattle in good condition.

That present methods of chemical analysis are inadequate to deal with the relative values of pasture grasses is generally agreed. Figures given by Wilson¹ show practically no difference in the composition of grass from poor low rented pasture and that from valuable fattening land. Hall and Russell² arrive at the same conclusion in their study of the fattening pastures of Romney Marsh. More discriminating methods of analysis are obviously required, for although a food may contain a sufficiency of mixed protein, it is only of limited value if some necessary specific protein is absent. Further, the estimation of the digestibility of food is full of difficulties, and even when this factor has been determined more or less satisfactorily we are confronted with the question whether the digested portion of the food is entirely or only partially available for animal nutrition.

¹ *Science Progress*, Vol. VII, No. 27, p. 426.

² *Journ. Agri. Science*, Vol. IV, p. 339.

In considering the composition of Indian fodders, however, we are not at present dealing with the finer points of digestibility and availability so much as with the fact that in order to obtain its necessary daily ration of protein an animal has to consume about twice as much Indian fodder grass as would be required if the grass came from a more temperate country. It has been found that the quality of a fodder is susceptible to climatic changes, while Crowther and Ruston¹ in their investigation of the ripening of grass for hay found that poverty in protein was characteristic of fodder grown in dull cool weather.

In view of the apparent poverty of Indian grasses, any other fodders which can be grown easily are deserving of attention. Leguminous fodders are particularly valuable, even the wild bulky legume *Alysicarpus rugosus* has a total protein content of over 13 per cent. The cultivated leguminous fodders like lucerne (*Medicago sativa*), Egyptian clover or *berseem* (*Trifolium alexandrinum*), etc., are naturally of the greatest value where they can be grown, but the fact that they are not found to seed locally militates against their general adoption.

Of the bulky fodders commonly fed to cattle in the Central Provinces and Berar, rice and wheat straw and *juar* stalks are the most important. Many other fodders have been tested on Government farms in the provinces; but with the exception of Egyptian clover (*Trifolium alexandrinum*) and the small bamboo (*Dendrocalamus strictus*) none of them has shown much promise of being suitable for adoption on a large scale. Egyptian clover or *berseem* does best when sown in rice fields about ten days or a fortnight before that crop is harvested. When the monsoon ceases in September, it does well when sown in a standing crop of early rice early in October; but if the rains are more prolonged, it does better if sown later in fields carrying medium or late rice. To secure uniform germination it is all important that the seed should be sown while the surface soil is still damp. By lying in contact with moist soil the seed germinates in four or five days, and the young clover

¹ *Journ. Agri. Science*, Vol. IV, p. 305.



Fig. 1. Young bamboos three years after planting.



Fig. 2. Cattle being fed with bamboo leaves.

plant is well established in about ten days, by which time the rice can be harvested. Clover sown in standing rice does better than that sown in open fields which have had to be cultivated before sowing. This would appear to be due to the fact that in its early stages the young clover plant does better when shaded from the hot glare of an October sun.

The seed rate required for clover broadcasted in standing rice fields is 40 lb. per acre. Within six weeks from the time of sowing the crop attains a height of about 15 inches. If cut at this stage, there will be a second growth ready a month later. Cuttings of from three to four tons per acre can be obtained every month from December till April, if the land is kept slightly moist by irrigation. The best time to irrigate is immediately after cutting. It is very responsive to manuring and it has been observed that when its cultivation is continued on the same land its outturn increases gradually. This may be due to the increase of nitrogen-fixing bacteria in the soil, or to the manurial value of the roots left behind, or to both. As a fodder it is easily the best of those which have been tested up to date in the Central Provinces. If it were possible to raise seed locally, the crop would undoubtedly have a great future; but under existing conditions the yield of seed per acre is only from 60 to 80 lb.

For poor light soils which cannot be irrigated, small bamboo (*D. strictus*) promises to be a most useful fodder, more especially in years of drought. Sir George Watt in his Dictionary of the Economic Products of India describes this bamboo as being densely tufted and gregarious, and as having strong and more or less solid culms of from 30 to 50 feet in height. It occurs on moderately dry hills throughout India and Burma, except in Northern and Eastern Bengal and Assam. It flowers after about 30 years; and after flowering the plants die. This bamboo does very well on the poor gravelly soils of the rice tract of the Central Provinces where the rainfall ranges from about 45 to 60 inches per annum.

Plate XXI, fig. 1, shows the height attained in three years by bamboos grown on "mooram" soils on the Chandkhuri Farm, Raipur. The seedlings were raised in an irrigated nursery and planted out in

the beginning of the rains. The first cutting taken in June after three years' growth yielded 19½ tons of green fodder per acre which was much relished by the farm cattle as will be gathered from Plate XXI, fig. 2. Though the tender twigs and green leaves of the older culms were removed from time to time during the rains no apparent injury was done to the culms. From the outturns already obtained, there is reason to believe that yields of from 40 to 60 tons of leaf per acre can be obtained from this variety of bamboo three years after planting. The analyses of the leaf both in the dry and green state made by the Officiating Agricultural Chemist are given in the statement below. Some analyses of other locally grown fodders are also given.

TABLE II.

Name of fodder	Moisture	Ether extract	Total nitrogen as protein	Soluble carbohydrate	Crude fibre	Ash*	*Including sand
1. Bamboo leaves, green, <i>D. strictus</i> ..	66·07	0·97	6·34	12·75	9·45	4·42	3·58
2. Bamboo leaves, air-dry, <i>D. strictus</i> ..	7·80	2·22	12·93	38·06	24·18	14·81	12·05
3. Bamboo leaves, green, <i>B. arundinacea</i>	63·48	0·89	3·96	16·25	10·32	5·10	3·85
4. Bamboo leaves, air-dry, <i>B. arundinacea</i>	6·86	2·26	10·09	41·46	26·32	13·01	9·81
5. Lucerne, <i>Medicago sativa</i> , dry ..	6·09	2·02	15·20	43·30	23·83	9·56	0·53
6. Berseem, <i>T. alexandrinum</i> , green ..	81·63	0·51	3·22	8·26	4·00	2·38	0·15
7. Juar fodder, <i>Andropogon Sorghum</i> , dry]	6·14	0·89	2·89	58·42	25·37	6·29	3·68
8. Average fodder grass, dry ..	8·24	1·52	3·30	44·00	32·54	10·41	7·80

It will be seen that of the most important constituents of food, viz., protein, oil and carbohydrate, dry bamboo leaves contain

nearly four times as much protein as is contained in the common grasses. The proportion of sand is somewhat high in both, and the proportion of indigestible fibre is greater in grasses than in bamboo leaves. The nutritive value of bamboo leaf appears to be at least equal to that of our grasses, while the yield obtained per acre is very much greater than that obtained from grass on similar soil. For the first cutting taken in June last year the variety *Dendrocalamus strictus* gave, as already pointed out, a yield of $19\frac{1}{2}$ tons per acre on the Chandkhuri Farm. Spear grass (*Andropogon contortus*), which is commonly found on this poor class of gravelly soil at present, ordinarily gives from $1\frac{1}{2}$ to 2 tons of green fodder per acre, which is equivalent to from 350 to 700 pounds of dry grass. It should be possible in parts of India where tracts of poor land are available and where the rainfall is suitable, to establish bamboo fodder reserves from which useful supplies of green fodder could be obtained for 7 or 8 months of the year, and from which bamboo hay could be made for utilization in years of fodder famine. That bamboo hay is a palatable fodder for cattle has been proved on the Telinkheri Dairy Farm, where an experiment is now being carried out to compare its feeding value with that of dry grass. In the green state it is already used as a fodder in certain parts of India. In this state it is supposed to possess medicinal properties and is commonly fed to ponies and cattle suffering from ailments such as "broken" wind and foot-and-mouth.

There are many other uses to which this bamboo could be put: its seed is a most welcome food-grain and its tender culms a welcome vegetable in famine years. Its mature culms are used as rafters and battens, or in the manufacture of mats and furniture. In jungly areas where bamboos are plentiful and where pigs abound, the cultivator fences his cane and vegetable plots with a fence made of split bamboos. There is, in short, good reason to believe that the systematic cultivation of this most useful species is well worth the serious consideration of the Department of Agriculture in this country.

SOME FACTS AND FIGURES REGARDING BANANA CULTIVATION.

BY

W. BURNS, D.Sc.,
Economic Botanist, Bombay;

AND

P. G. DANI, B.A.,
Of Bombay Agricultural Department.

THE following facts and figures are culled from a mass of records of two plantations in the Ganeshkhind Botanical Garden, and may be of some use in giving more accurate information regarding this important crop.

Two varieties were used. In the first plantation was planted a variety locally known as *Soni*, with a medium-sized, very sweet, yellow-skinned fruit. The area of the plot was 23 *gunthas*, that is 23/40ths of an acre. The suckers were put in at 15 feet apart each way, and were 110 in number. The main objects of this plantation were to provide material for

- (1) observation of the development and morphology of the inflorescence and flowers of the banana ;
- (2) study of the problems of pollination, fertilization, and hybridization.

Incidentally other observations were made or recorded in the cultivation sheets, and it is these that are here presented in a highly condensed form.

It should be mentioned that this work passed through the hands of no less than three assistants and hence there was some little trouble in disentangling facts from the records, but the statements now made are sound.

The plantation was destroyed in March 1919. The total yield of raw fruit for the plantation from June 1915 to this date was as follows :

	YIELD	
	for 23 <i>gunthas</i>	calculated per acre
Weight	15,637 lb.	27,194 lb.
Number of fruits	81,066	140,984

The original sucker we called the mother-sucker, and the following suckers that came into bearing on the same stool we called the first, second, etc., sucker-generation. Suckers were cut away from the stool at first so as to leave one in bearing, one half-grown and one just starting. Later on this rule was not strictly observed. The total number of suckers that came into bearing during the time of the experiment was 494, representing the mother generation and up to three sucker generations after it.

The average yield per sucker (mother or daughter) during the period of experiment was 31.65 lb. in weight or 164 fruits in number.

A manurial experiment was carried out, the plot being divided into two, one part treated with a mixture recommended by Dr. Mann and the other receiving local treatment. Later on both plots received the same treatment. The following are the dates and methods of manuring, the quantities given are per stool :—

June 21, 1915	Both plots received 80 lb. farmyard manure per stool, at time of planting.		
June 26, 1916	Sub-plot 1 received 20 lb. poudrette and 1 lb. Dr. Mann's formula, and Sub-plot 2, 40 lb. poudrette.		
Jan. 11, 1917	Do.	Do.	Do.
	(Manurial experiment ended.)		
Feb. 9, 1917	Both plots received 140 lb. farmyard manure and one lb. bone meal per stool.		
June 1, 1917	Do.	Do.	100 lb. poudrette.
Jan. 23, 1918	Do.	Do.	100 lb. poudrette.

The manurial experiment has been recorded in the Annual Report of the Ganeshkhind Botanical Garden for the years 1915-16, 1916-17, and 1917-18 and in Bulletin No. 89 of the Bombay Agricultural Department. There is no need to say more of it here than to state that the pouquette plus Dr. Mann's formula proved the better treatment.

Watering was done at ten-day intervals.

The attached table is a record of the behaviours of three stools (numbers 14, 46, and 77) taken at random in the whole plantation.

Tree No.	Date of harvests	No. of days between harvests	Weight of fruit produced	No. of fruits produced	Fluctuation	
14 mother	1-11-16	1 year and 130 days from planting.	lb. 18	130	..	
A gen.	13-9-17	312	28	183	+53	
B „	1-7-18	288	36	218	+35	
46 mother	23-9-16	1 year and 92 days from planting.	24	154	..	
Sister suckers	{ A gen.	15-5-17	232	31	172	+18
	{ A „	7-8-17	82	60	207	+35
Do.	{ B „	25-5-18	288	44	230	+23
	{ B „	24-6-18	30	53	216	-14
77 mother	31-8-16	1 year and 70 days from planting.	8	104		
Do.	{ A gen.	5-4-17	215	48	248	144
	{ A „	8-4-17	3	41	253	+5
	{ A „	7-8-17	119	25	145	-108
Do.	{ B „	11-5-18	274	16	157	+12
	{ B „	1-6-18	20	50	203	+46
	{ B „	13-6-18	12	40	228	+25
	{ B „	14-7-18	31	52	180	-48

On examining the above table we see that from the date of planting to the date of fruiting of the bunch the average

number of days required is one year, three months and seven days.

From the date of harvest of the mother to that of next generation the interval is 280 days.

The same from A to B is 298 days.

The yield in the first generation is more by an average of 72 fruits than that of the mother, and is still more by an average of 3 in the second generation than the first. (Here the average of three stools is taken.)

The appearance of the inflorescence is always heralded by the appearance of leaves which we have named *transition* leaves, intermediate between a foliage leaf and a bract. The text-figure shows their appearance.

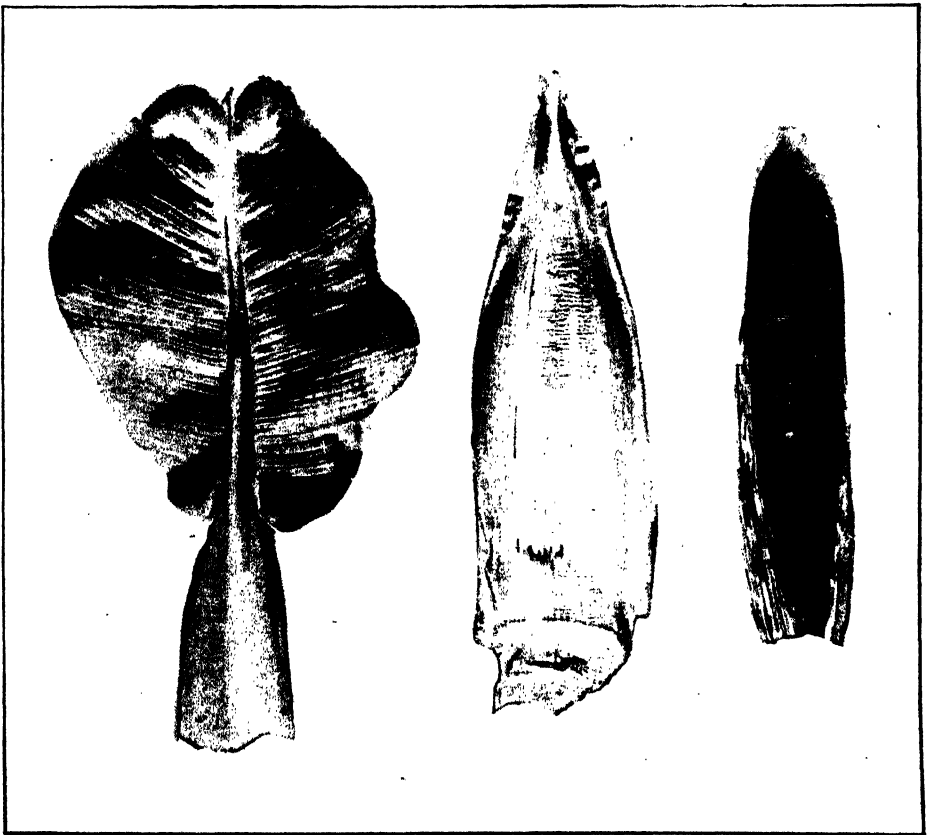

Transition leaves 1 and 2, and first bract of a banana plant.

The average interval between the appearance of the first transition leaf and the harvesting of the bunch was as follows :—

	No. of trees averaged	No. of days
Mother generation	23	121
Sucker „	9	156
„ „	4	153
„ „	4	166

The second plantation consisted of plants of the *Rajeli* variety from Walhe village on the Madras and Southern Mahratta Railway. This variety is elsewhere known as *Rajapuri* or *Gujarathi*. This is a variety more dwarf in habit and with a more angled and slightly coarser fruit than *Soni*. The area planted was 8 *gunthas* (8/40ths of an acre) and the distance between trees each way was 11 feet. The total number of trees was 72. The plantation was begun on July 8, 1916, and destroyed in the beginning of March 1919.

The total yield for the whole plantation during its existence was :—

	YIELD	
	for 8 <i>gunthas</i>	calculated for one acre
Weight	4,687 lb.	23,085 lb.
Number of fruits	17,210	86,050

The average number of sucker generations per stool was two.

The average yield per sucker was 21·27 lb. or 79·30 fruits.

The manurial treatment was as follows :

July 8, 1916 .. 50 lb. of poudrette per stool, at the time of planting.

June 1, 1917 .. 100 lb. of poudrette per stool.

Watering was done at ten-day intervals.

Taking three stools at random (Nos. 24, 32, and 49), the following are details regarding time of fruiting, etc :—

Tree No.	Date of harvest	No. of days between harvests	Weight of fruit produced	No. of fruits produced	Fluctuation
24 mother ..	31-7-17	1 year and 23 days from planting.	lb. 40	114	
A gen. ..	20-4-18	260	70	151	+37
B „ ..	5-8-18	105	29	130	-21
32 mother ..	25-8-17	1 year and 47 days from planting.	40	88	
A gen. ..	27-4-18	242	24	102	+14
B „ ..	10-9-18	133	18	79	-23
49 mother ..	13-9-17	1 year and 65 days from planting.	16	64	
A gen. ..	3-5-18	230	50	149	+85
B „ ..	21-2-19	288	19	62	-87

On examining the foregoing table we see that from the date of planting to the date of fruiting of the mother plant the average number of days required is one year and 45 days.

The interval between dates of successive harvests is—

an average of 244 days from mother to first generation, and

.. .. „ 119 first to second generation.

As to yield there is an average increase of 46 fruits in the first sucker generation and an average decrease of 44 fruits in the second generation.

The following calculations show the probable profits from the cultivation of the *Soni* variety in the Poona District.

Cost of cultivation.

Cost of labour :—man charged at the rate of 8 as. per day.

woman do. do. 4 as. do.
 child do. do. 4 as. do.
 bullock do. do. 4 as. do.

Farmyard manure at Rs. 2 per cart and poudrette at Rs. 2-4-0 per cart.

Two cart-loads are equal to one ton (2,240 lb.)

One basket is equivalent to 20 lb.

56 such baskets make one cart-load.

(The whole time of the existence of the plantation is taken as three years and six months. The following are calculated per acre.)

EXPENDITURE.

No.	Operations, &c.	Rs. A. P.
1	Two ploughings crosswise by an iron plough (T ₂ or Arlington, two pairs and two men for 4 days	8 0 0
2	Disking and harrowing, one pair and one man for the whole day	1 8 0
3	Digging pits; size 2½' x 2½' x 2½'. Pits required for an acre 15 feet apart are 193. One man digs 5 pits in one day, 39 men finish the work in one day	19 8 0
4	Suckers required 200, at the rate of Rs. 10 per 100	20 0 0
5	Manuring at the time of planting, F. Y. M. 80 lb. per plant (14 cart-loads required)	28 0 0
6	Carting manure at R. 1 per cart	14 0 0
7	Planting suckers; one man plants about 25 suckers in one day	4 0 0
8	Harrowing and levelling after planting	1 0 0
9	Preparation of beds and water channels, one man prepares about 16 beds of the size required per day	6 0 0
10	Irrigation charges; water generally given for 10 months in a year excepting rainy season; 30 waterings in all for one year. Irrigation Department charges per acre Rs. 22-8-0 for crop like plantain (G. R. No. 6371, dated 27th June, 1917), for three and half years	78 12 0
11	Watering charges; in all 105 waterings for the whole time of the plantation; one man can irrigate one acre in a day	52 8 0
12	Stirring, digging and weeding the beds once every three months. 12 men can finish it in one day. 14 such operations	84 0 0
13	MANURING: Generally manured every six months. For the method of manuring as described above on page 387 the total cost comes to	173 10 0
14	Land assessment to Government for three years at the rate of Rs. 4 per acre	12 0 0
15	Rent of land on lease for three and half years at the rate of Rs. 20 per acre	70 0 0
16	Harvesting charges; per bunch 3 pies, for 868 bunches	13 9 0
	Total cost	586 7 0
INCOME.		
	Yield per acre in number of fruits, 140,984; sold wholesale on the plot itself at Rs. 10 per 1,000	1,409 13 0
	Subcrop like chillies, etc., taken for the first six months. The net profit per acre for such a crop comes to	50 0 0
	Spare suckers sold at the rate of Rs. 10 per 100	52 0 0
	Total income	1,511 13 0
	Deducting cost of cultivation	586 7 0
	We get a net profit for three and half years	925 6 0
	So, for one year, the net profit for banana cultivation is	265 0 0

SOME NOTES ON COTTON IN SIND.

BY

K. I. THADANI, B.AG.,

Of the Department of Agriculture, Sind.

THE economic significance of natural crossing is a matter of the first importance, as it affects the improvement and introduction of varieties and also distribution of seed. Hence it is worth while to estimate the extent to which it occurs and also to find out an efficient means of protection against it. Professor Gammie, from the failure of emasculated flowers exposed to natural crossing to fertilize, was led to believe that Indian cottons were normally self-fertilized, but the most reliable method of obtaining accurate information on the subject should be based on a study of single plant cultures.

During the course of the writer's selection work on the local cotton (*Gossypium neglectum*) in Sind, he has been dealing with a large number of single plant cultures for the last few years, and the record of the examination of their progeny may give a clue to the present inquiry. The local cotton in Sind is composed of four varieties, two with white flowers, namely, (1) *Neglectum rosea* and (2) *Neglectum cutchica*, and two with yellow flowers, namely, (3) *Neglectum vera* and (4) *Neglectum malvensis*. It has been shown by Leake and corroborated by Fyson that white colour of the petals in the cotton flower is recessive while yellow is dominant. If that is so, the extent of natural crossing can be determined with certainty from the behaviour of the progeny of the white-flowered plants exposed to natural crossing; while the examination of the progeny of the yellow-flowered plants will not help much, as the

first generation hybrids always assume the dominant form and thus escape detection.

In the year 1915-16, sixty-four white-flowered plants were marked in an ordinary field where all forms were growing mixed. Each was picked separately, sown next season in line culture and the progeny examined. Three cultures were lost and the detailed results of the remaining sixty-one cultures may be summarized as under :—

Variety	No. of single plant cultures	No. of cultures breeding true to type	No. of cultures splitting	Percentage of plants affected by natural crossing
<i>Neglectum rosea</i> ..	34	6	28	84
<i>Neglectum cutchica</i> ..	27	8	19	70

In the year 1916-17, fifty white-flowered plants were similarly marked in a mixed field, separately picked and sown next season in line cultures. The detailed results of the examination of the progeny are summarized as under :—

Variety	No. of single plant cultures	No. of cultures breeding true to type	No. of cultures splitting	Percentage of plants affected by natural crossing
<i>Neglectum rosea</i> ..	28	6	22	79
<i>Neglectum cutchica</i> ..	22	5	17	77

Similarly, the selection of ninety-nine white-flowered plants in the year 1917-18, sown next season, gave us the following results :—

Variety	No. of single plant cultures	No. of cultures breeding true to type	No. of cultures splitting	Percentage of plants affected by natural crossing
<i>Neglectum rosea</i> ..	49	19	30	60
<i>Neglectum cutchica</i> ..	50	14	36	72

The results of the selection of 1918-19 are as under :-

Variety	No. of single plant cultures	No. of cultures breeding true to type	No. of cultures splitting	Percentage of plants affected by natural crossing
<i>Neglectum rosen</i> ..	36	16	20	55
<i>Neglectum cutchica</i> ..	10	5	5	50

The results show that vicinism causes from 50 to 84 per cent. of the plants to become affected by natural cross-fertilization. The percentage would be still higher if we were to take into consideration fertilization between sister plants which remain undetected. It has been further found that one plant bears on an average twenty flowers and that the affected plant gets on an average two of its flowers naturally crossed. At that rate the percentage of natural cross-fertilization would amount to from 5 to 8.5 per cent.

Since natural crossing is annually occurring and is a permanent source of trouble, confusion, and error, any practical means of protection against it would be simply invaluable not only from economic considerations, but also in solving genetic problems. In all line cultures, specially in Mendelian work, covering of the plants or the flowers is an absolute necessity. Several devices are resorted to, such as paper covers, muslin bags, nets, rings, sutures, etc. Whatever the device, the labour involved is considerable and there is always a certain percentage of flowers that do not set. Further, Mr. Leake found that the effect of continued covering leads to sterility. Apart from this, the application of these devices is limited to small cultures, being of no avail for cultivation on a field scale where roguing and insolation are the only means of protection.

During the course of the writer's observations on the cotton flower he chanced upon a flower which was marked (among several others) at 10 o'clock in the morning, when it was a full bud, for the purpose of recording the exact time when it would open. After two hours the bud was very much swollen but the tip was

completely sealed, maintaining the shape of the bud, while other flowers had opened their petals wide apart. The particular flower was kept under observation, every hour until evening, but the petals never opened; the bud began to shrivel from 2 o'clock, showing that fertilization had taken place inside. Observations were continued till the next day, but the petals did not open as was expected from the shrivelled appearance of the closed petals on the previous day. It was then properly marked and labelled for collection of seed. When the boll was formed a small bag was put on lest cotton should drop on the ground when the boll burst. The same evening while rambling in his cotton plots the writer found some fertilized flowers with closed petals as distinct from those that had opened as usual. The circumstances led to the search of some more cleistogamic flowers and the writer was able to find about a dozen and a half on which observations were taken during the full course of a day. It may be further remarked that the plants on which cleistogamic flowers were discovered had mostly opened all the flowers except the one closed flower that was found. The case is analogous to that of Nilsson who discovered that in pure lines of oats occasional grains appear that are aberrant either in colour or morphological characters. The variations tested by him either bred true at once, or after one or two generations practically all of the progeny bred true to the character.

Now it remains to be seen if this character is hereditary or if it can be fixed. The very existence of cleistogamic flower suggests that a race could be bred in which the flowers would admit no crossing. In conclusion, the writer is reminded of a passage from Balls who, while describing the various means of protection against natural crossing, says:—

“Another obvious possibility is the discovery or manufacture of a cleistogamic flower which shall absolutely refuse to admit foreign pollen to its style. At one stage of these researches the author seemed to be well on the road to success in this direction and the story of ultimate failure is not without suggestiveness.”

Failing to find anywhere a hint of the existence of uncrossable cotton flowers, Balls was led to experiment on a short style flower in which the opportunity of foreign pollen to reach the style was small, and came to the conclusion that the accessibility of the style was a minor factor in natural crossing under the conditions of our breeding plot.

STUDIES IN BIOCHEMICAL DECOMPOSITION OF COW-DUNG AND URINE IN SOIL.*

BY

N. V. JOSHI, B.A., M.Sc., L. Ag.,

Offg. Assistant Agricultural Bacteriologist, Pusa.

IN a previous paper on nitrification of green manures, read at the last Science Congress, by the writer, it was shown that certain plant tissues, *e.g.*, stems and roots, fail to nitrify in soil, even under optimum conditions of temperature and moisture, and also as a result of further experiments it was suggested that "the failure to nitrify, so far as ascertained, does not depend on the nature of the nitrogenous materials. It is probably due to nitrate reduction occurring in the presence of great quantities of non-nitrogenous materials, such as cellulose and woody tissue." In order to find out whether and, if so, how far this explanation is applicable in the case of other organic nitrogenous materials, experiments with a number of different manures like oil-cakes, cattle-dung and urine, and sheep-fold manure, etc., were initiated, but as it would unduly lengthen the paper if we were to deal with all the substances examined at one time, it is proposed here chiefly to deal with the trials made separately with cattle-dung and urine only. These two materials are of the greatest importance to the agriculturist, especially in India, as they form principally the only sources of manure to the small cultivator in this country where practically no artificial manures or oil-cakes are employed in the usual farm practice, except by planters or rich cultivators. It will perhaps be asked at the outset why experiments with farmyard manure direct were not so far carried out, since farmyard manure

* Paper read at the Seventh Indian Science Congress, Nagpur, 1920.

is the most commonly used manure all over the world, and both the materials experimented with, *viz.*, cattle-dung and urine, are associated together in the farmyard manure as its chief constituents. It may be pointed out, however, in reply that the work on farmyard manure is complicated by the fact that this manure undergoes several chemical and bacterial changes during storage and further the quantities of dung and urine which are added in different places while making up the farmyard manure are subject to such a wide variation that no useful purpose would have been served by taking up the study of farmyard manure at once; especially as it was considered that more useful information could be obtained by studying, in the first instance, the decomposition of the two materials—dung and urine—separately, either before or after fermentation. Besides, the study of the decomposition of these substances separately was more suited to our purpose as the difference in the chemical composition of these substances is already known. The urine of animals contains nearly all the potash and a good deal of nitrogen with only a very small amount of phosphate, while the non-nitrogenous material present is very much smaller as compared with dung which contains a proportionately larger amount of non-nitrogenous materials. The amount of phosphate voided with the dung is also comparatively larger. Moreover, the urine contains the plant foods not in solid form as in the case of the dung, but in solution. It was therefore proposed to see in the first instance which of these two substances in a fresh condition, *i.e.*, before fermentation, is more easily nitrified, as the knowledge whether any particular organic substance would readily decompose in a soil so as to be immediately available to the crop is likely to be very useful to the agriculturist.

The study of the decomposition of these substances after they were separately stored and had undergone fermentation was also further taken up as it was considered to be of practical value from the point of view of conservation of farmyard manure. Owing to fermentation and drainage, the loss from the manure kept in the ordinary way is a very serious item, and the problem of conservation of farmyard manure would be much simplified if it were

known which of these substances is responsible for the serious losses known to occur during storage of this manure. Although it is doubtful whether such a study will confer immediate benefits or solve the problem at once, the writer was led to undertake the investigation in the hope of getting some useful data. The results so obtained form the subject matter of the present paper and are presented here with a view to elicit useful criticism.

While studying the nitrification of cattle-dung and urine, it was the writer's original intention to study and compare the decomposition of sheep dung and urine, but it was not possible to arrange to get these separately. Only sheep-fold manure (*i.e.*, a mixture of dung and urine) was available. Trials with this are included here just to indicate what kind of results can be expected with the mixture of dung and urine obtained.

Cow-dung and urine and sheep-fold manure were brought to the laboratory in fresh condition and were immediately analysed for their moisture and nitrogen content. These being determined, they were then separately added to each kilo of air-dry Pusa soil at the rate of 30 mgm. of organic nitrogen per 100 gm. of dry soil (equivalent to 750 lb. of N per nine inch acre), water was added so as to make up the moisture content of the soil up to 16 per cent., allowance being made for the water already contained in the manures. The manures were then thoroughly mixed with the hand and each lot filled in separate glass bottles covered and kept at 30° C. in the incubator. It would be useful here to mention that the quantities of nitrogen and moisture stated above had been found to be optimum for the Pusa soil for nitrification and were therefore adopted in these experiments.

Samples for analysis were taken after thoroughly mixing the soil, to determine quantitatively the amount of ammonia, nitrite and nitrate formed at the end of each week for the first four weeks, after which time determinations were made at an interval of two weeks.

The methods of analysis were the same as those employed on the previous occasion.¹

¹ Joshi, N. V. *Agric. Journ. of India*. Special Indian Science Congress No., 1919, p. 400.

CHART I.

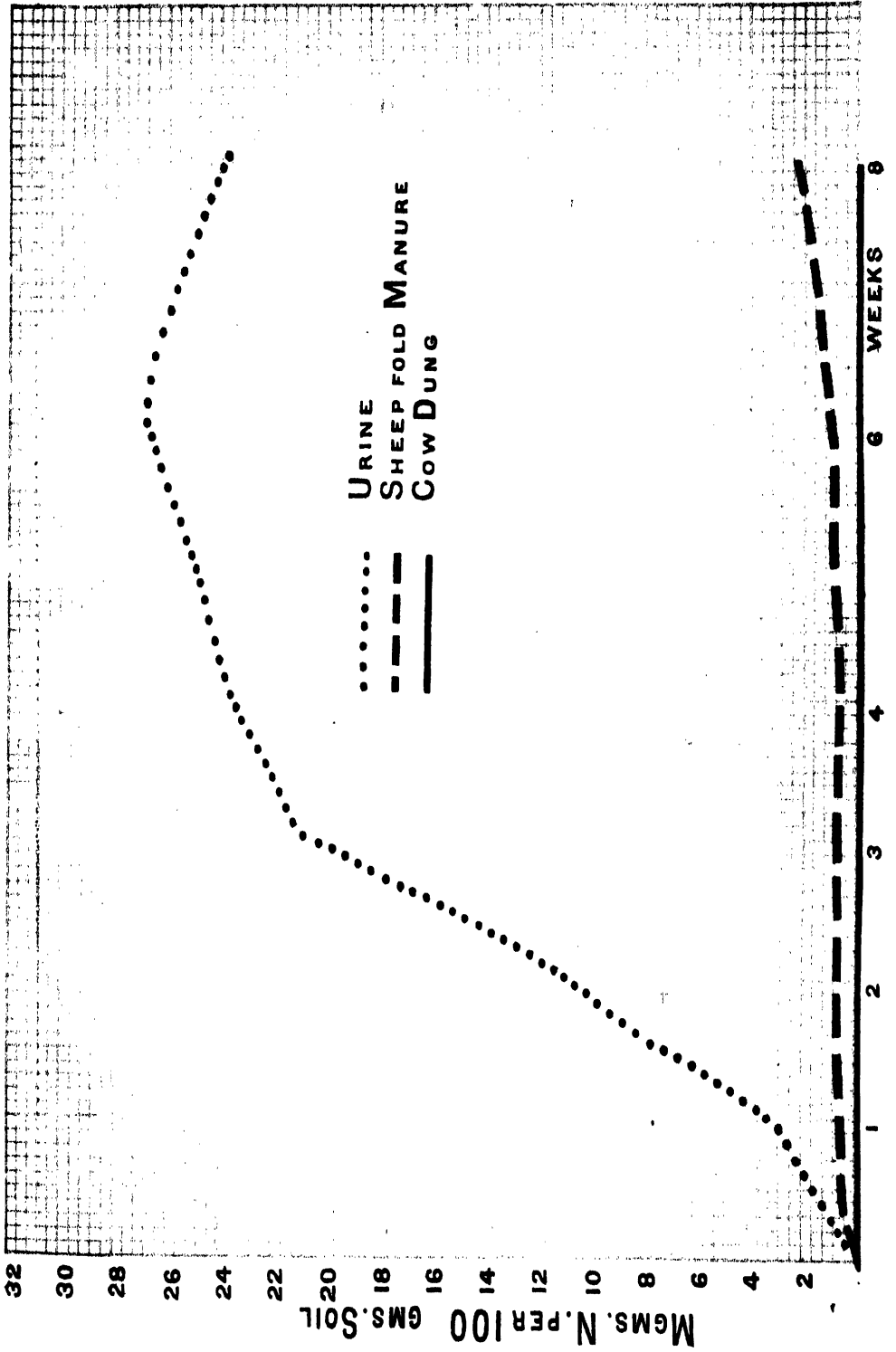
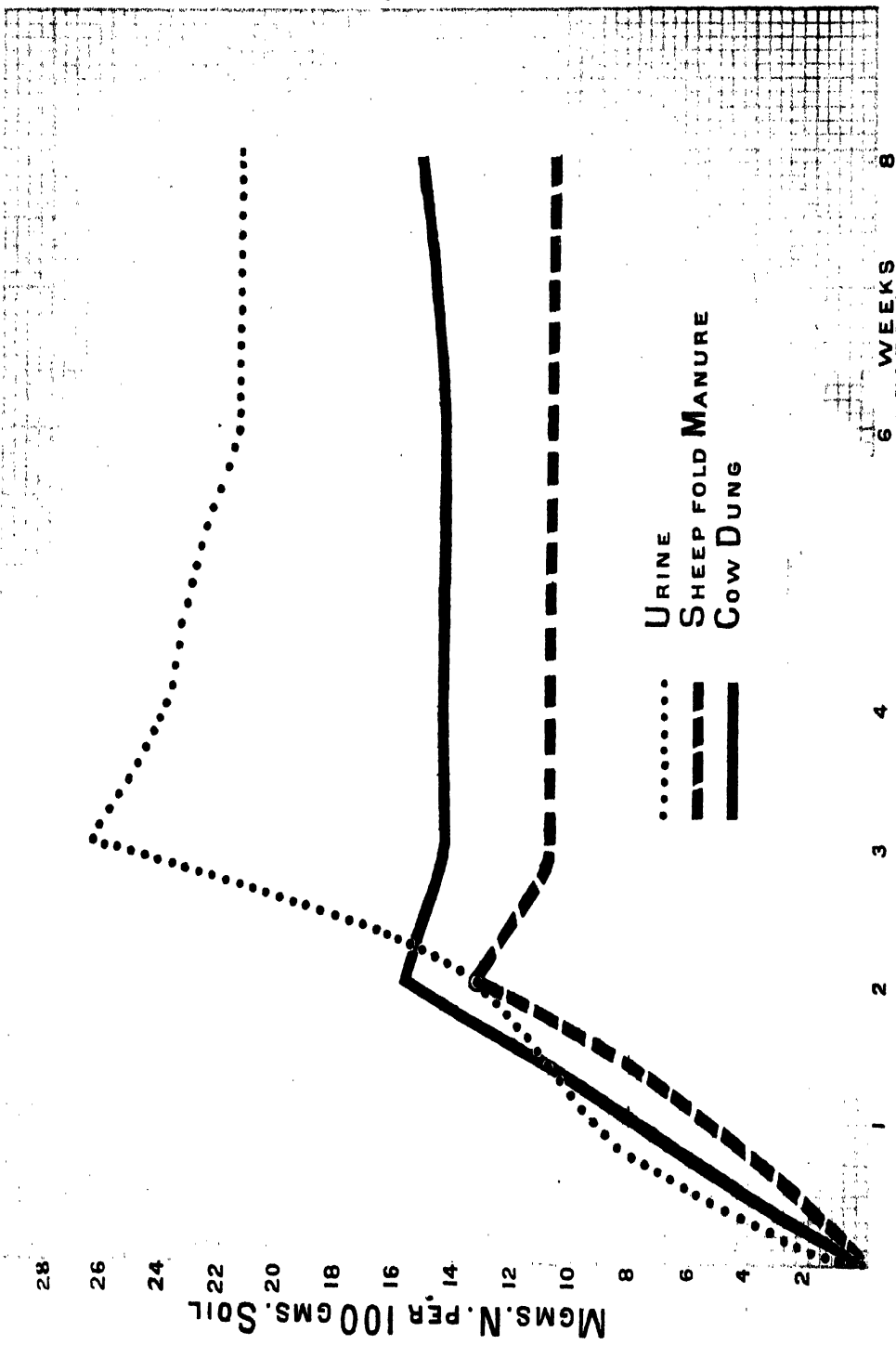

CHART II.



In Chart I, the amounts of nitrates formed by the decomposition of cow-dung, urine and sheep-fold manure, as found by analysis, are plotted in the form of curves. It is clear that cow-dung does not show any nitrate formation. Urine shows the greatest amount of nitrates, while sheep-fold manure, which is a mixture of dung and urine, stands between the two. In the opinion of the present writer these results confirm the previous contention that the absence of nitrate accumulation (as in the case of cow-dung and sheep-fold manure) is due to the nitrate reduction occurring in the presence of great quantities of non-nitrogenous materials such as cellulose, since the nitrates are found to vary inversely as the amount of non-nitrogenous material. Cow-dung, which contains the greatest amount of non-nitrogenous material associated with the nitrogenous one, shows the least amount of nitrates; urine, which has the least amount of non-nitrogenous material associated with the nitrogenous one, has given rise to the greatest amount of nitrate; while sheep-fold manure is intermediate between the two, both as regards its non-nitrogenous content and the amount of nitrates found.

Since farmyard manure consists mainly of dung and urine which have undergone some changes, aerobic as well as anaerobic, in heaps or manure pits, it was proposed to see what effect the storage has on the decomposition of each of these materials singly with special reference to nitrate formation. For this purpose the materials left over after use in the first experiment and kept in open jars with clock glass covers were used. Fresh determinations of nitrogen and moisture content were made and the materials were then separately added to soil on the same basis—30 mgm. N per 100 gm. of soil as before. Chart II gives the results showing that while urine has retained its place as regards high nitrifiability, cow-dung and sheep-fold manure have exchanged places; cow-dung, after storage, is superior to sheep-dung, and further a greater amount of nitrogen has been transformed into nitrates both in the case of the stored cow-dung and sheep-fold manure than the amounts so transformed from these substances in fresh condition.

The results of one experiment were, however, considered insufficient proof, because it was realized that the composition of cow-dung is not uniform in all seasons and might also vary with the food given. Another experiment was therefore arranged on the same lines as before about four months after the first, and this time the addition of straw (which usually finds its way into the manure heap) was introduced as a variation, so that each of the materials used was tried, with and without straw, there being thus six bottles instead of three as in the previous two experiments. The straw added amounted to only 0.5 to 0.6 per cent. of the quantity of dung employed, although the amount of straw heaped together with cow-dung in the manure pit was estimated to be about 20 per cent. of the quantity of dung. This estimate is confirmed by the figures, kindly supplied by Dr. Mann, of one particular experiment lasting for one week made at the Poona Agricultural College Farm.

The figures are as follows :—

Cow-dung	3.886 lb.
Straw	862 lb.

which show that the straw is about 22.2 per cent. of the cow-dung.

The smaller quantity of straw was employed because in some other experiments it had been found sufficient to show its effects on the course of nitrification.

Chart III illustrates the results. It will be seen that they are of the same type as those obtained in the two previous experiments, and further that the addition of straw had the effect of lowering the amount of nitrate found in each case.

In order to see the effect of storage as in the previous case, cow-dung, urine and sheep-fold manure which had remained after use in the third experiment were divided each into two equal lots and each lot was stored in a separate jar. The jars were then divided into two sets. Jars in one set comprising one lot of each of these substances were covered with ground glass plates, which were then made airtight on the edges of the jar by rubber lute with a view to exclude the outside air, thus securing the storage of the materials under anaerobic conditions as far as possible. In the other set the jars had only paper covers and thus had access to

CHART III.

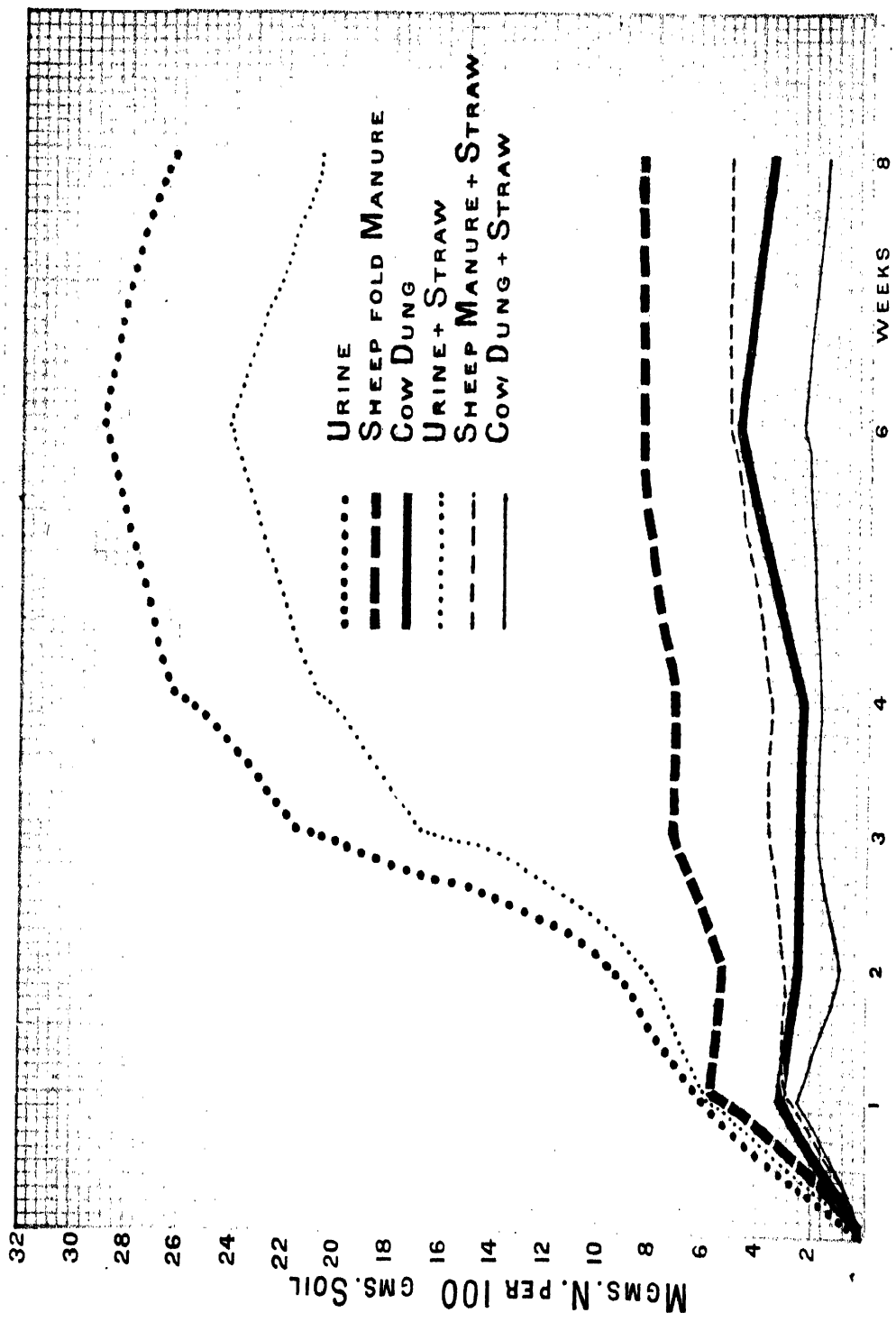

CHART IV.

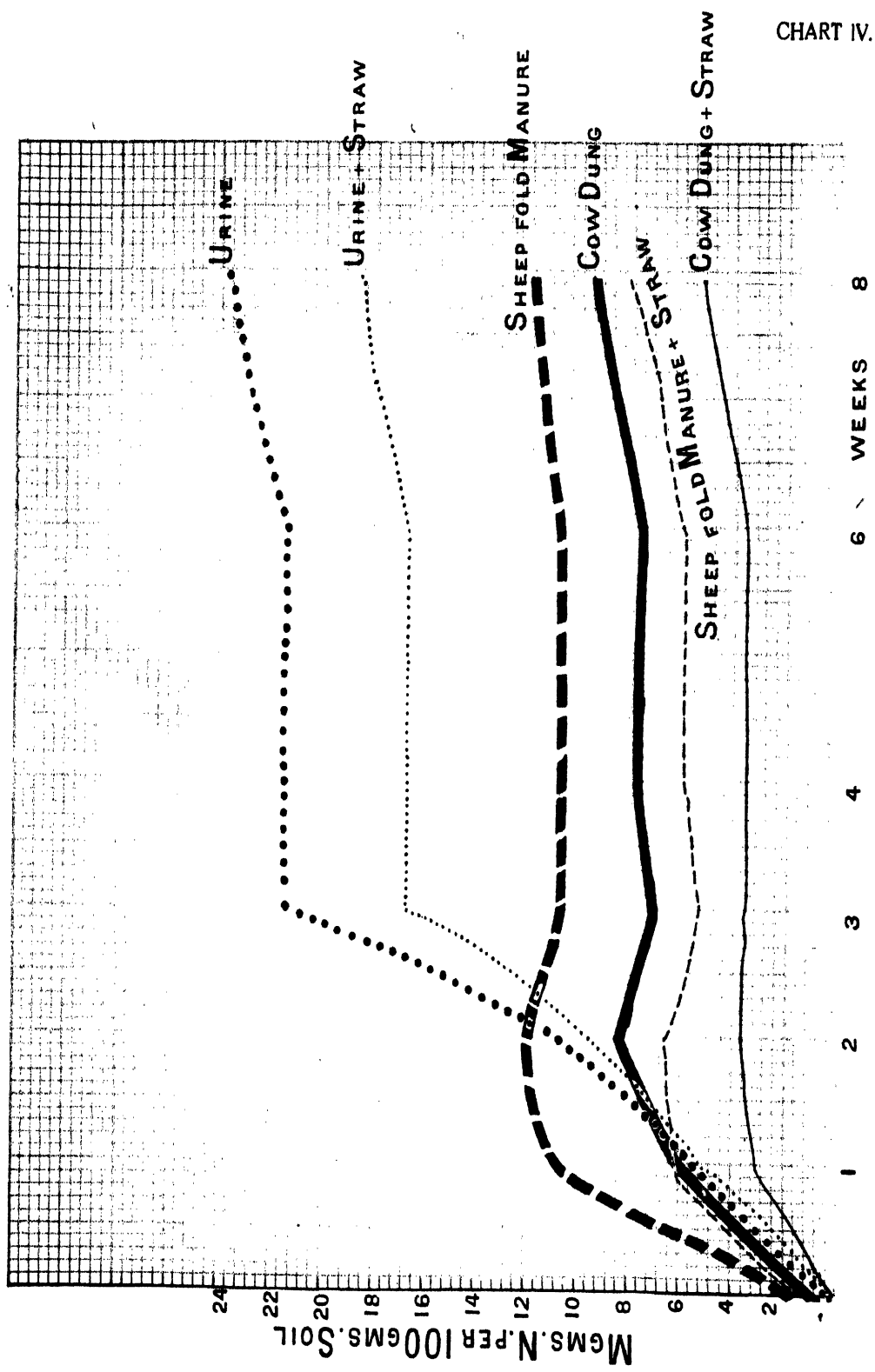
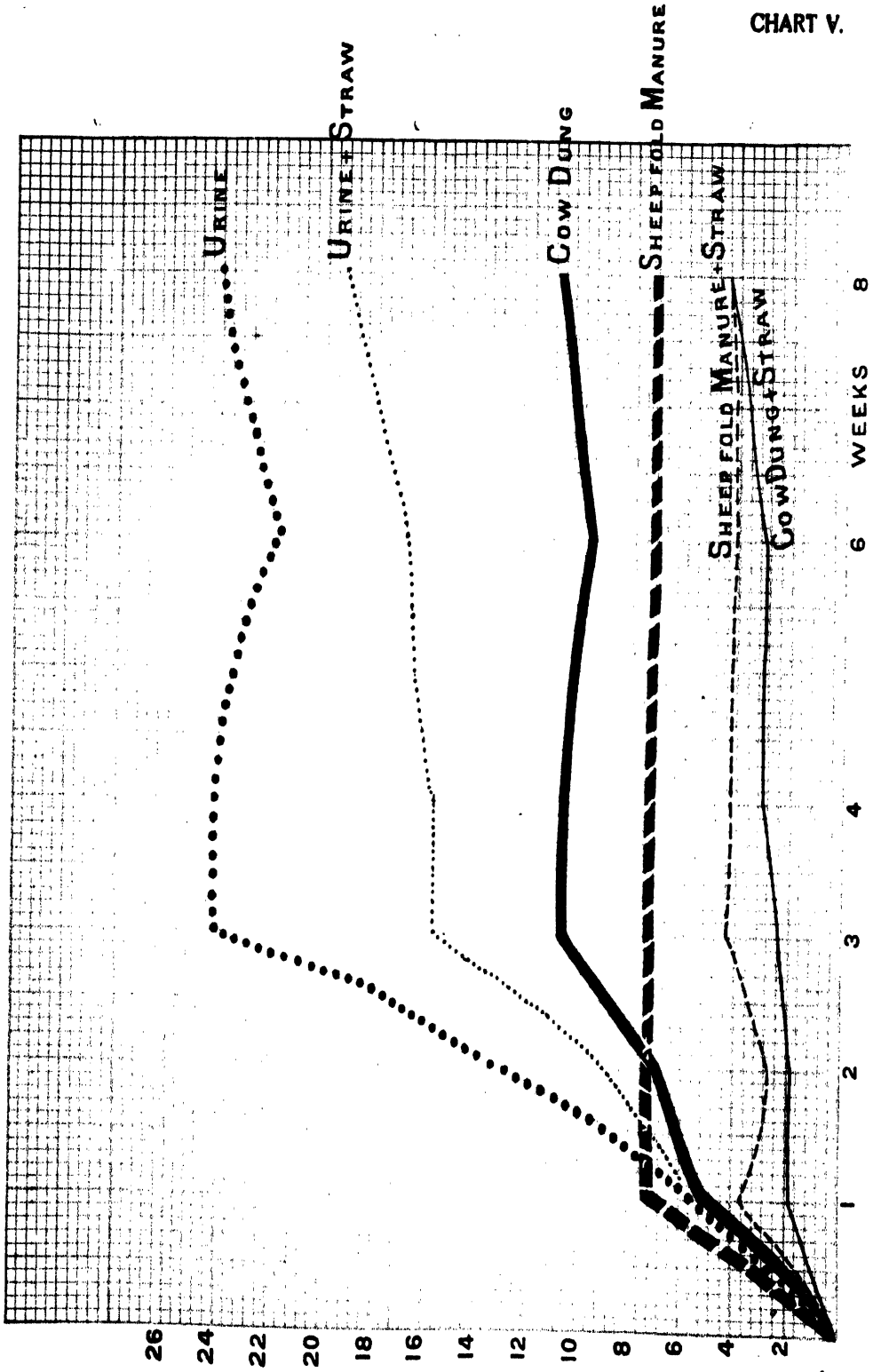

CHART V.



outside air; this set is therefore called "aerobic." No attempt was, however, made to pass the current of air over the materials in the aerobic set. Both these sets of jars were left at laboratory temperatures varying between 28° C. to 30° C. After a few months' storage under these conditions, the materials as fermented were taken out, their moisture and nitrogen content determined and then they were separately incorporated in the soil. The variation introduced by the addition of straw was retained in both cases. Other conditions of the experiment were also the same as before. The results are shown in two separate charts, Nos. IV and V. The aerobically fermented materials have practically given the same results as in the previous case, except that the sheep-fold manure gives slightly more nitrates than the cow-dung. In the case of the anaerobically fermented ones it will be seen that although urine retains its high place as regards its nitrifiability, the anaerobically fermented sheep-fold manure and the anaerobically fermented cow-dung have changed places. The straw has shown its effect, *viz.*, that of lowering the amounts of nitrates, in every case. Comparing the results of the two sets it may be observed that although there is very little difference between the amounts of nitrate formed from the cow-dung fermented aerobically or anaerobically, still there is a good deal of difference between the two lots of sheep-fold manure. This is illustrated in a separate chart (No. VI) comparing the two, from which it will be seen that the anaerobically fermented sheep-fold manure is inferior to the aerobically fermented one. As such difference is not noticeable in the case of cow-dung or urine when each of them is stored separately, but noticeable only in the case of sheep-fold manure, it is natural to enquire whether this inferiority with reference to nitrifiability of the anaerobically fermented sheep-fold manure is not due to the fact that it is a mixture of dung and urine; and whether separate storage of dung and urine of cattle would not be more advantageous than the addition of the urine into the manure pit? The question is well worth further study not only from the point of view of nitrifiability of material but also from another point of view, *viz.*, the loss of nitrogen during storage, as it was incidentally noticed that under anaerobic

conditions of storage there was no loss of nitrogen from urine, that from cow-dung only slight, but sheep-fold manure under anaerobic conditions lost more nitrogen than either.

Under aerobic conditions there was loss in all cases, but as the figures for loss in moisture under these conditions were not accurately determined beforehand, no opinion can be expressed as to the relative loss of nitrogen from each of the materials. This question of loss of nitrogen during storage is being further investigated to obtain more accurate information.

It must have occurred to many that the experiments carried out so far are open to one serious criticism, *viz.*, the excessive amounts of materials used in the experiments. These are no doubt higher than the amounts normally employed in the field. But these quantities were taken with due regard to the amount of nitrogen which had previously been found suitable for nitrification experiments with Pusa soil and to the fact that the concentration of nitrogen should be such as to enable one to detect even small differences in what may be termed the nitrifiability of materials. In order, however, to leave no room for criticism of such a kind, and also on account of the very wide differences in nitrifiability of materials compared (as already noticed in these trials), a fresh experiment was arranged in which the quantities employed approximated to what may be called heavy manuring such as is given to garden crops or other soil-exhausting crops like tobacco. The quantity of manure employed was calculated on the basis of 50 cart-loads, *i.e.*, about 25 tons of farmyard manure per acre. For ordinary crops 25 cart-loads are considered sufficient for Pusa soil. These quantities were found to supply 15 mgm. of N per 100 gm. of soil instead of 30 mgm. as before. The addition of straw was retained as a variation. Sheep-fold manure was not available at the time. Soil alone and soil plus straw were introduced as controls.

In addition to nitrification experiments, CO₂ production experiments were carried out. The CO₂ produced in soil by each of these treatments was measured every day in order to see whether there is any relation between the process of nitrification, as represented by

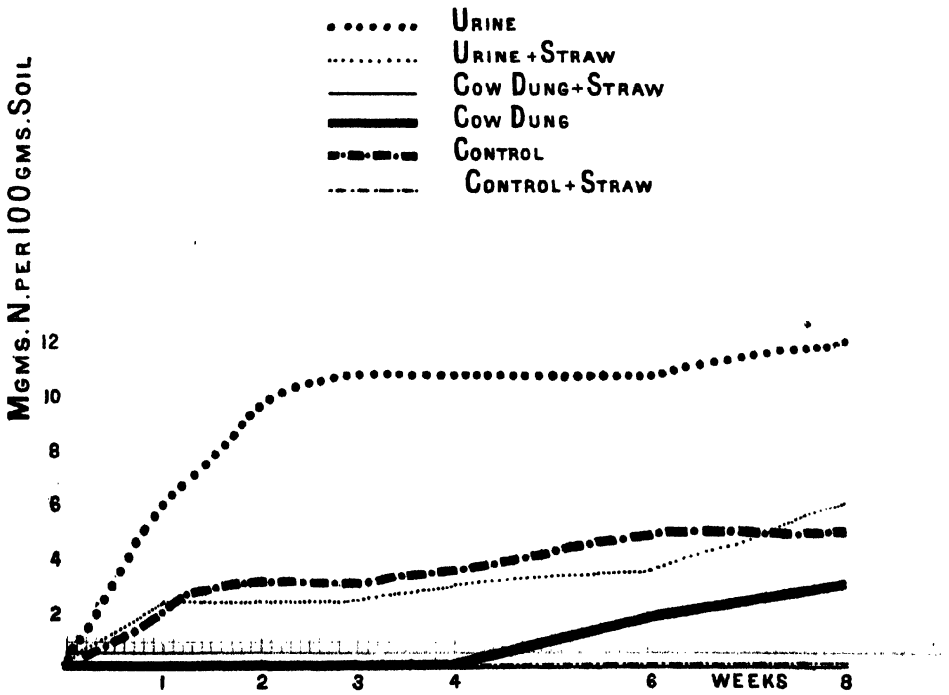
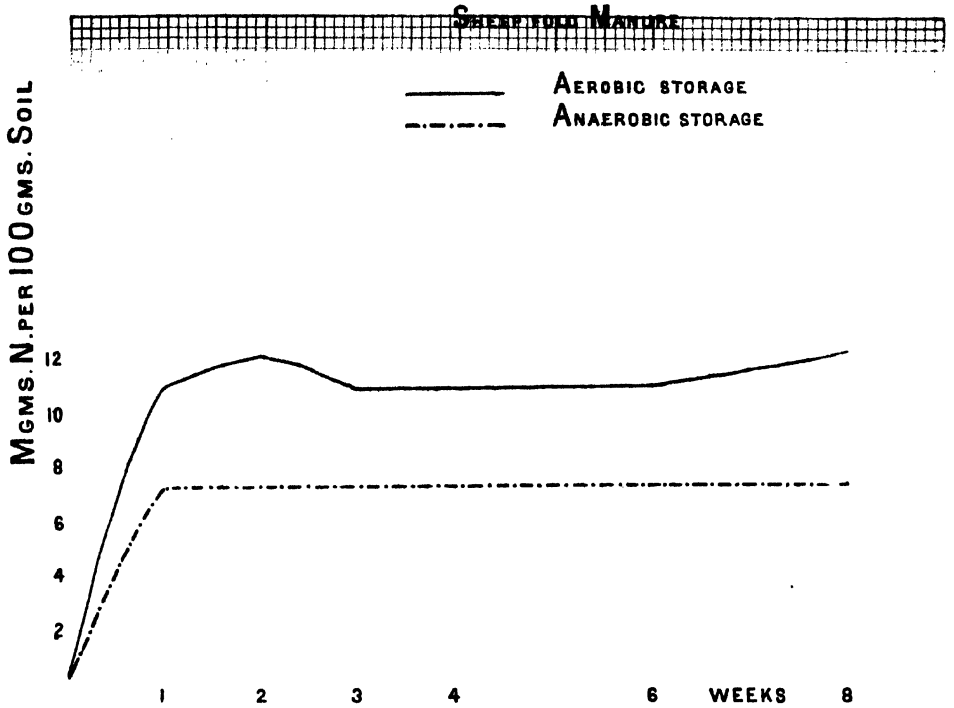
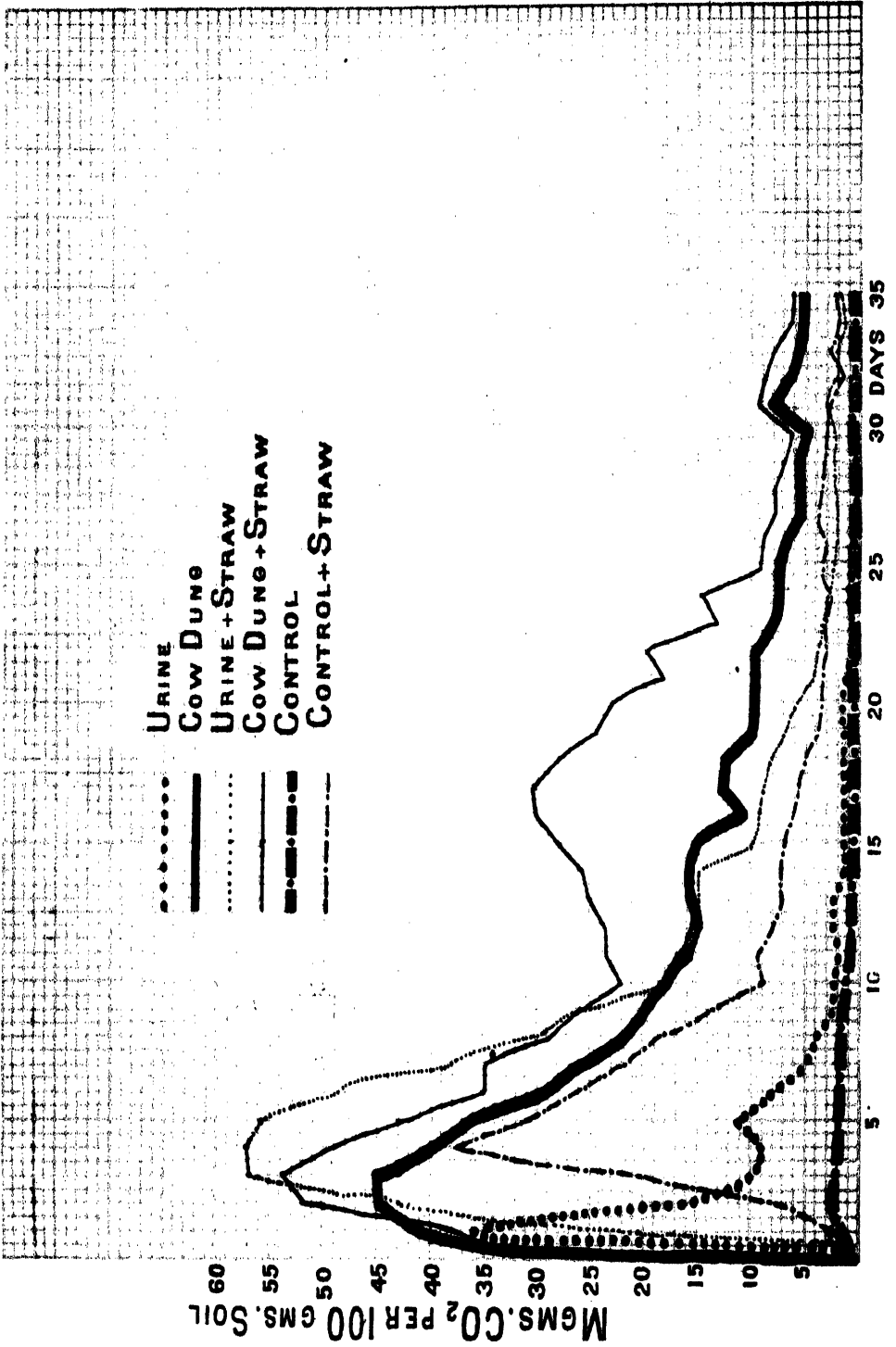

CHART VIII



the amount of nitrates which are the final product of the nitrogen changes, and the process of CO_2 production, which latter may be said to measure the general biological activity of the soil.

Furthermore, soils receiving the different treatments were plated out and bacterial counts made to see whether the number of bacteria and the amount of CO_2 produced could be correlated.

It was considered advisable to determine also the total nitrogen along with ammonia, nitrites, nitrates, etc. Besides, samples of soil were taken from each nitrification jar for determining the moisture content, loss on ignition and humus every week.

Charts VII, VIII and IX and Table I show the results which may, in general, be set down as follows.

The nitrate curves (Chart VII) fully confirm the results obtained in the previous two cases; fresh cow-dung shows practically no nitrate formation, while urine shows the highest. The addition of straw, as in the previous experiments, lowers the amount of nitrates.

The CO_2 production (Chart VIII) shows practically an inverse order as regards cow-dung and urine, cow-dung giving a much higher amount than urine. As regards the effect of addition of straw on CO_2 production, it may be observed that increased amounts of CO_2 are produced where straw is added as in the case of the control plus straw and urine plus straw as compared to the corresponding lots without straw. In the case of cow-dung, however, no such marked difference is observable, which may be explained by the fact that cow-dung itself contains a large quantity of undigested cellulose material; a further small addition in the shape of straw does not therefore affect the results to any great extent. The fact that nitrate curves and CO_2 curves are in the inverse order, and further that the addition of straw while lowering the amounts of nitrates leads to increased production of CO_2 needs to be emphasized. Previous writers have, on account of the similarity of curves for nitrate content and CO_2 production, tried to justify the view that the two processes are related to each other. It will appear as a result of our experiments, however, that these two processes are not necessarily correlated.

Chart IX illustrates the curves for bacterial numbers. A comparison of this chart with the previous one of CO₂ production shows a close similarity between the two sets of curves, which leads to the inference that the CO₂ production is directly related to the bacterial numbers.

Figures for total nitrogen are given in the accompanying table.

TABLE I.

Milligrams of total Nitrogen per 100 gm. of soil.

Treatment	Original	1st week	2nd week	4th week	6th week	8th week
Soil control ..	57.4	57.4	57.4	57.4	56.0	56.0
Soil + straw ..	60.2	60.2	60.2	60.2	61.6	61.6
Soil + cow-dung ..	75.2	79.8	79.8	81.2	81.2	81.2
Soil + cow-dung + straw	78.0	82.6	81.2	82.6	88.2	86.8
Soil + urine ..	72.4	70.0	70.0	68.6	72.8	71.4
Soil + urine + straw ..	75.2	79.8	79.8	79.8	82.6	79.8

It is interesting to note that the figures for total nitrogen determined weekly are higher in those cases where there is less nitrification (*e.g.*, in all those cases where straw has been added), and in order to account for this fact, it requires to be investigated whether there is any loss of nitrogen during nitrification or whether there is greater nitrogen fixation with the cellulose materials. A third alternative possibility, which has to be considered, is that the method for estimation of total nitrogen (which is meant and supposed to include nitrates) may be at fault. It is necessary, therefore, to examine critically whether any loss of nitrogen occurs during digestion, when nitrates in unusually greater quantities are present.

It may be mentioned that in the method used for determining the total nitrogen in the soil, copper sulphate was used instead of mercuric oxide, as this was recommended by Scott¹, and also because it was found that the use of the latter consistently gave lower

¹ Scott. *Standard Methods of Chemical Analysis*. Second Ed., p. 295.

CHART IX.

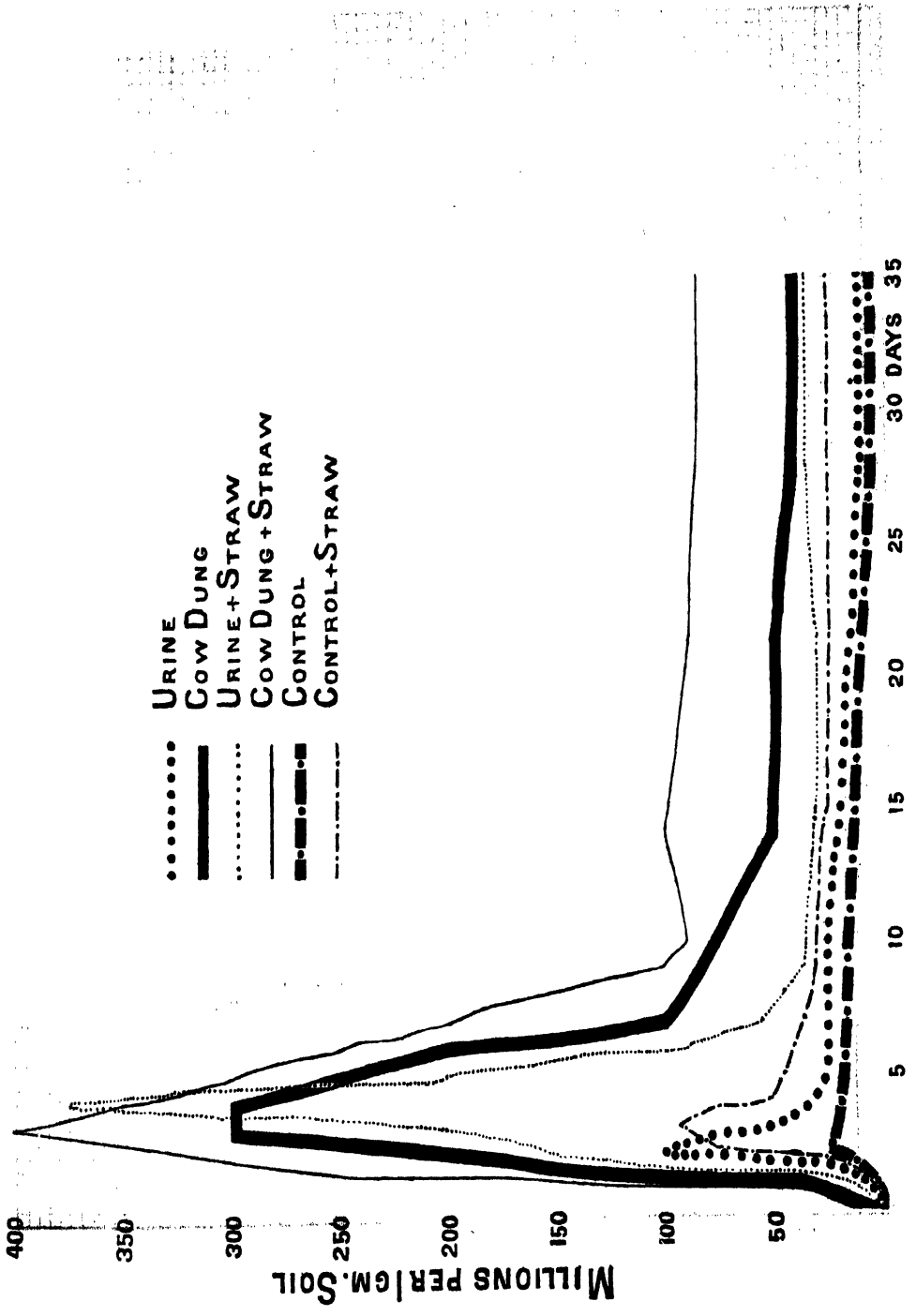

figures, whenever both the methods were compared, in the case of Pusa soil. Whether this result is due to impurities in mercuric oxide remains to be seen.

The only other feature of interest in the rest of the analytical results is that about 50 per cent. of the total humus is found to be free, the rest is combined with lime.

By way of anticipating criticism it might be observed that while the biological decomposition of organic matter is generally recognized to be of fundamental importance to soil fertility, it is nevertheless questioned by many whether a study, even under field conditions, of the processes leading to the decomposition of organic matter, and the assimilation of the resulting products by the plant, is of any real value. According to this line of argument, still less importance attaches to analytical figures obtained in the laboratory of nitrate nitrogen and CO_2 produced. In reply to this it must be said at once that laboratory results are not at all intended to be put forward as directly applicable to field conditions. There is an essential difference between laboratory and field observations, but each has got its own value. Whereas the field observations record the combined result of many factors, the effect of each of which it is not possible to distinguish in the field at once, the investigations in the laboratory give the results of each of the factors singly under rigidly controlled conditions, all factors except the one under investigation being kept constant. Attention might be called, for instance, to the observed differences in nitrification of the different tissues of green manures already described in a previous paper¹ and the differences in the decomposition of cow-dung and urine described in this paper. It would have been hardly possible to distinguish accurately between these differences in the field and, even if observed, most likely they would have been mixed up with some other factor like rainfall.

It may be further mentioned that the value of these laboratory observations on differences in nitrification, described in this paper, lies also in enabling us to distinguish between the separate effects

¹ Joshi, N. V. *Agri. Journl. of India*. Special Indian Science Congress No., 1919, pp. 395-413.

of the two factors which are involved in manuring with organic nitrogenous fertilizers, *viz.*, the formation of nitrates, and the improvement in physical texture, each of which must affect to a certain extent the crop-producing power of the soil.

In order to discover how far the analytical results of nitrification tests are related to the crop-producing power, pot experiments with leguminous and non-leguminous crops are being carried out with dung and with urine added to the soil in the same proportion as that employed in the last experiments. These experiments are intended to elucidate how far crop production is influenced by variation in nitrification, and also to see what effect physical improvement alone, without any nitrates, has on the crop-producing power of a soil.

The results of the experiments detailed in this paper may now be summarized as follows :—

The opinion expressed in a previous paper that non-nitrogenous materials, like cellulose, lower the amounts of nitrates formed from the organic manures in which they are present in a fairly large proportion is confirmed by experiments with cow-dung, sheep-fold manure and urine.

Urine gives the greatest amount of nitrates, whether in fresh condition or when fermented under aerobic or anaerobic conditions, and so it can be used immediately or after keeping. Urine, if kept exposed to air, loses some of its nitrogen. It is therefore advisable to store it in such a way as not to be accessible to air.

Cow-dung does not nitrify in fresh condition. It, however, improves by storage and becomes nitrifiable after storage under both aerobic and anaerobic conditions. The relative losses under each of these conditions require to be more accurately determined before finally deciding which of these conditions is better so far as nitrifiability is concerned.

Results with sheep-dung indicate that mixture of dung and urine in the manure pit is not desirable from the point of view of nitrate formation, and also on account of the possibility of greater losses of nitrogen from such a mixture under partly anaerobic

conditions which are likely to prevail in the pit or even in a compact heap.

The two processes of nitrification and of CO_2 production, though sometimes found to correspond with each other, do not seem to be necessarily correlated. Nothing definite can be said as yet as to the relation of crop production to nitrification. It is hoped that the experiments now in progress will clear up this point.

COMPARISON OF SALT LANDS IN THE DECCAN AND IN SIND.*

BY

V. A. TAMHANE, M.Sc., L.Ag.,
Of the Bombay Agricultural Department.

ORIGIN OF SALT LANDS IN SIND AND IN THE DECCAN.

THE origin of salt lands in Northern India, such as that in the alluvial tract of Sind, and in the South Deccan, which is a trap area, is widely different. In the one, the soils, which are transported, show in vertical sections that the layers of alluvial deposit often vary greatly. It is not unusual to find in such sections layers of pure sand alternating with those of pure clay. The layers themselves usually differ very much in their thickness. All this indicates that the nature of soils in such alluvial tracts can scarcely be uniform, with the result that the development of salts is also very irregular and even a small piece of land measuring a few *gunthas* (40 *gunthas* = one acre) is often seen studded with patches of alkali salts whereas the rest of the field has normally good land. In places like those of Sind where the rainfall is almost negligible and where the sub-soil water table is much more than ten feet below ground level, the development of salt is neither due to water-logging, nor due to the sub-soil water table being within the range of capillary power of the soils, which is generally found not to exert a pull of more than four feet on the sub-soil water.

Inundation flood, which is the chief source of irrigation at present in the northern parts of Sind, supplies water for cultivation

* Paper read at the Seventh Indian Science Congress, Nagpur, 1920.

during the months of June to September. After that severe extremes of weather follow. Excessive cold in winter and scorching heat in the hot season help a great deal in the disintegration of soil particles through which water moves in the downward direction during inundation season and in upward direction for the remaining eight months of the year. It is this downward and upward movement of water in the upper few feet of the soils which is responsible for the formation and deposition of salts in the alluvial tract of Sind.

In the Deccan the soils are mostly formed *in situ* by the disintegration of trap rock, and in vertical sections of soils all the stages of disintegration of the rock can be seen : such as the soil, *murum* or half disintegrated trap rock forming the sub-soil, and below it hard rock unaffected by the natural agencies of weathering. It is on this account that the soils in the Deccan are not so variable in their nature as the soils in Sind and the patchy nature of salt-affected land is not so common (though not altogether absent) as it is in the north of Sind.

The origin of salt lands in the Deccan is to be found in the general rise of sub-soil water table which has risen so high after the introduction of perennial canals as to be within five feet from the surface of the land and oftentimes even less than this. In such cases the sub-soil water constantly rises to the surface by capillarity, and evaporating there, leaves the dissolved salts behind. The lands in the Deccan are, moreover, not so level as those in Sind, so that the soils on lower level are more affected by seepage and water-logging than those on higher level.

NATURE OF ALKALI SALTS IN THE DECCAN AND IN SIND.

In the Deccan alkali salts are mostly formed by the disintegration and decomposition of trap rock, which is known to be one of the hardest of the common rocks. It is, however, found to yield comparatively easily to the natural agencies of weathering, being at one time covered under the water of the flowing river or canal, etc., and at other time being exposed to the heat of the sun. Probably the soluble salts in the river and canal water also help the

process of weathering. The trap rock being thus the origin of salts, it is interesting to know the nature of salts found to form from it during the process of decomposition.

The following table shows the nature of the river and canal water which always comes in direct contact with the trap rock :—

	Karha river water at Jejuri. Parts per 100,000	Nira Canal water at Pimpra. Parts per 100,000
Calcium carbonate	6·00	8·00
Magnesium carbonate	8·00
Sodium carbonate	5·00	1·00
Sodium bi-carbonate	4·00
Calcium sulphate	5·00
Magnesium sulphate	4·00
Sodium sulphate	4·00
Sodium and potassium chloride	13·00	6·00
	40·00	24·00

The trap rock, which under the influence of such water disintegrates and decomposes, was found to liberate the following salts in the proportion given below :—

	Slightly dis- integrated trap rock	Much dis- integrated trap rock
	%	%
Total soluble salts	1·13	1·15
COMPOSITION OF SALTS :—		
Calcium carbonate	18·50	2·60
Magnesium carbonate	1·30
Calcium sulphate	16·20	..
Magnesium sulphate	12·30	11·30
Sodium sulphate	23·50	12·50
Sodium chloride	23·00	82·50

This shows that sodium sulphate and sodium chloride predominate over all the other salts when trap rock is undergoing decomposition.

It is interesting to compare with these analyses the figures of analyses of salts found in the scrapings from barren salt land near Baramati in the Nira Valley :-

			Scraping I	Scraping II
			%	%
Total salts in dry soil	9.70	37.60
COMPOSITION OF SALTS :—				
Calcium carbonate	5.40	0.20
Calcium sulphate	3.40	0.40
Magnesium sulphate	2.30	0.30
Sodium sulphate	48.70	98.00
Sodium chloride	40.00	1.20

These figures also show the preponderance of sodium sulphate and sodium chloride in the composition of alkali salts found in barren salt lands of the valley.

The following are some of the typical analyses of soluble salts from particular spots which show the gradation from fertile to barren land commonly found near Malad in Baramati :—

	FERTILE SPOT		SPOT WITH POOR CROP		BARREN LAND	
	Surface-3"	3"-9"	Surface-3"	3"-9"	Surface-3"	3"-9"
	%	%	%	%	%	%
Total salts in dry soil	0.39	0.22	0.58	0.86	3.86	1.06
COMPOSITION OF SALTS :—						
Calcium carbonate	3.90	12.90	2.40	2.90	6.20	2.40
Magnesium carbonate	..	5.90
Sodium carbonate	4.40	8.60	1.60	7.00	2.60	1.10
Calcium sulphate	20.00	..	37.30	8.20	28.00	12.50
Magnesium sulphate	9.10	4.20	26.50	8.90
Sodium sulphate	..	49.50	..	22.60	..	8.50
Calcium chloride	16.20	..
Magnesium chloride	7.80	..	13.40	..
Sodium chloride	62.20	19.90	24.20	59.40	41.90	66.50

In the majority of the alluvial tracts of Sind, the alkali salts are not naturally derived from any particular rock as the alluvium deposited there is of a varied character, being a mixture of

disintegrated particles of various rocks existing on the top of the Himalayas and down in the flats of the Punjab. There is therefore no particular rock whose decomposition products can be compared with those of the trap rock of the Deccan, the alkali salts in Sind being decomposition products of the alluvium itself.

The waters of the Indus and its canals which come in direct contact with the alluvial deposits gave the following analyses when the waters were collected during dry season :—

	Indus water near Sukkur	Water from the Hiral Canal
	Parts per 100,000.	
Total soluble salts	30·00	22·00
CONTAINING :—		
Calcium carbonate	5·01	6·24
Magnesium carbonate
Calcium sulphate	12·72	1·56
Magnesium sulphate	6·83
Calcium chloride	1·93
Magnesium chloride	6·86	3·25
Sodium chloride	1·16	1·78

The following are some of the typical analyses of alluvial deposits which are not yet injured by the accumulation of harmful salts :—

	Good land under cotton. Soil surface-6"	Good garden land. Soil surface-6"	Good land under wheat. Soil surface-6"
	%	%	%
Total soluble salts ..	0·13	0·21	0·30
CONTAINING :—			
Calcium carbonate ..	0·05	0·05	0·07
Sodium carbonate	0·02	0·02
Calcium sulphate	0·01	0·02
Magnesium sulphate ..	0·01	..	0·03
Calcium chloride	0·02	..
Magnesium chloride ..	0·05	0·04	0·01
Sodium chloride	0·06

Scrapings from barren lands of different types which could be clearly distinguished by the presence of white and black 'kalar'* gave the following composition :—

	I. White <i>kalar</i> at Sarhari	II. Black <i>kalar</i> at Sukkur	III. Black <i>kalar</i> at Nawabshah
	%	%	%
Total salts in dry soil ..	24.60	20.24	7.80
COMPOSITION OF SALTS :—			
Calcium carbonate ..	0.13	0.19	0.39
Sodium carbonate ..	0.05	..	0.13
Calcium sulphate ..	5.73	14.15	9.78
Magnesium sulphate ..	1.13
Sodium sulphate ..	9.12
Calcium chloride	10.66	22.46
Magnesium chloride	14.21	21.14
Sodium chloride ..	83.84	60.79	46.10

It is clear from these figures that chlorides form more than 80 per cent. of the total salts of which sodium chloride is more than 45 per cent. Sulphates are present from 9 to 14 per cent. of the total salts, and in the white *kalar* sodium sulphate is present to the extent of 9 per cent. of the whole quantity of the salts. Sodium carbonate forms only a negligible quantity of the total salts which shows that the *kalar* of Sind is not of a very bad type.

A very remarkable thing that comes out of these analyses is the fact that sodium carbonate is not a necessary constituent of black *kalar*. It is usually supposed that sodium carbonate has a caustic action on the organic matter of the soil which gives a black appearance to the surface soil and hence the name black *kalar* to sodium carbonate, so that black *kalar* means sodium carbonate. From the above figures, however, it will be seen that No. II does not contain any sodium carbonate at all and No. III contains only a very small quantity, and yet the appearance of the surface soil at both these places is sufficiently dark to distinguish the spots as affected by black *kalar*. The only salts in No. II and No. III

* *Kalar, Lona, Usar, Reh* are synonymous terms used in different parts of India to mean salt efflorescence on the land.

to which the dark appearance of the soil may be due are calcium chloride and magnesium chloride. Of these, the former is known to have corrosive action on organic matter.¹ The black *kalar* on Sind soils, therefore, does not contain any appreciable quantity of sodium carbonate but contains a fairly large quantity of calcium chloride and magnesium chloride which are not injurious to plants like sodium carbonate or sodium sulphate.

On comparing the different types of *kalar* in Sind with those of *lona* in the Deccan it will be at once clear that the salt efflorescence in the Deccan contains comparatively a very large proportion of sodium sulphate, whereas in Sind sodium chloride predominates over all the other salts.

RESISTANCE OF CROPS TOWARDS SALTS.

In the Deccan the ordinary black soil does not usually contain more than 0·1 per cent. of soluble salts, but this does not necessarily mark the limit of salts up to which crops can be grown. Several crops have been found to resist the effect of salts much beyond this quantity, and the following are some of the analyses which indicate the limit of tolerance shown by some of the ordinary crops.

	Sugarcane. Soil surface-5"	<i>Chowli</i> (<i>Vigna</i> <i>catjang</i>). Soil surface-4"	<i>Wal</i> (<i>Dolichos</i> <i>lablab</i>). Soil surface-4"	Gram (<i>Cicer</i> <i>arietinum</i>). Soil surface-4"
	%	%	%	%
Total salts in dry soil ..	0·96	0·45	0·42	0·42
COMPOSITION OF SALTS:—				
Calcium carbonate ..	6·80	12·62	4·76	5·24
Sodium carbonate	0·97	5·00	1·19
Calcium sulphate ..	43·00	33·00	3·33	30·70
Magnesium sulphate ..	1·00	28·65	9·53	15·24
Sodium sulphate ..	25·90	8·74	57·86	20·49
Sodium chloride ..	23·30	16·02	19·52	27·14

Of these crops sugarcane was growing excellently, being also supplied with heavy manuring. *Chowli* and *Wal* were doing fairly well and gram germinated well but failed later on.

¹ U. S. A. Bureau of Soils Bulletin No. 34.

COMPARISON OF SALT LANDS IN THE DECCAN AND SIND 417

Lakh (*Lathyrus sativus*) and Udid (*Phaseolus radiatus*) were similarly found to fail in a soil containing 0.48 per cent. of soluble salts of which sodium sulphate was about 66 per cent.

The following are a few of the analyses of Sind soils showing approximate limit of tolerance of some crops towards salts contained in the soil :—

	Rice. Soil surface-6"	Lakh (<i>Lathyrus sativus</i>). Soil surface-6"	Cotton. Soil surface-6"	Wheat. Soil surface-6"
	%	%	%	%
Total salts in dry soil ..	1.86	0.61	2.10	3.00
COMPOSITION OF SALTS :—				
Calcium carbonate ..	3.16	18.64	3.85	1.14
Calcium sulphate ..	8.87	16.94	51.92	22.05
Magnesium sulphate ..	14.55	27.51	10.26	..
Sodium sulphate ..	18.96	..	14.74	..
Calcium chloride	18.25
Magnesium chloride	20.34	..	16.35
Sodium chloride ..	54.43	16.94	19.23	42.21

The resistance of rice crop towards sodium chloride is well known from the fact that several rice varieties are grown on creek water in Konkan near Bombay.

In Sind, on Larkhana farm, saline water which could just maintain rice crop was found to contain the following amounts of salts :—

	Water confined in rice crop. Parts per 100,000	
Total soluble salts	940.00
CONTAINING:—		
Calcium carbonate	5.17
Calcium sulphate	63.68
Magnesium sulphate	43.56
Sodium sulphate	38.34
Sodium chloride	742.50

The above is only an attempt to show approximately the limit of tolerance of several crops towards salt efflorescence in soils. Other factors such as frequent irrigation and consequent dilution during different stages of growth of the crops would materially modify the results.

HABIT IN SUGARCANES.*

BY

U. VITTAL RAO, L. Ag.,

Assistant to Government Sugarcane Expert, Madras.

HABIT OF PLANT AN IMPORTANT CHARACTER IN ALL CULTIVATED CROPS.

HABIT of plant is a character of considerable importance in all cultivated crops. That each individual plant should be able to make full use of the air and light available to it without interfering with the growth of the neighbouring plants is a condition imposed by agriculture and the closer approximation of the individual plants which agriculture implies. Again, the habit of plant has often a direct bearing on the position of the produce at time of harvest. A cotton plant in which the lateral branches spread on the ground and bring the *kapas* in contact with the soil, dirtying it and thus depreciating its market value, and a paddy plant, which, by its spreading nature, allows its ripe earheads to trail on the ground, are obviously unsuitable for cultivation.

PARTICULAR IMPORTANCE OF HABIT IN SUGARCANE.

Habit is of special importance in the case of the cultivated sugarcanes. It is a long duration crop—occupies the land for 9 to 14 months in India, and even as much as 24 months in other countries like Hawaii—and if the neighbouring plants should show a tendency to get entangled with each other, the inter and after cultivation of the crop such as weeding, earthing and irrigation are rendered difficult. Secondly, it is accepted on all hands that

* Paper read at the Seventh Indian Science Congress, Nagpur, 1920.

a lodged cane rapidly degenerates in sucrose content. Dr. Leather, in *Agricultural Ledger*, 1896, says, "The juice of fallen canes was again separately examined, with the result that it was found to contain generally less proportion of cane sugar and a larger one of glucose than was found in the standing cane." Thirdly, a bad habit in the cane leads to the formation at the time of harvest of crooked and curved canes, which is a serious disadvantage from the factory point of view, as it seriously interferes with the compact packing of canes on the hopper. In sugarcane, the ideal would, therefore, be to aim at getting a variety which will consist of a series of parallel erect canes.

HABIT OF THE MAIN SHOOT DURING THE EARLY STAGES OF GROWTH.

During the early years of the Sugarcane Breeding Station, the depressed habit of the Madras seedling, M. 2, was studied by Dr. C. A. Barber, C.I.E., and Rao Sahib T. S. Venkatraman, and the results were presented in the form of a paper at the Madras Session of this Congress in the year 1915. It was there proved that the depressed habit in the particular Madras seedling was an inherent character resulting from geotropism. This year the study was extended to 20 varieties, chiefly the indigenous Indian canes belonging to the various groups classified by Dr. Barber in his Memoir, "Studies in Indian Sugarcanes, No. 3." Four buds were put down for each variety, but owing to casualties and other abnormalities in growth caused by shoot borers, etc., only 37 plants could be studied to the end of 87 days from planting, and the results are here given.

Statement showing the actual plants studied.

Group	Variety	No. of buds planted	No. of plants examined
THICK CANES ..	J. 247	4	4
NARGORI ..	Nargori	4	1
	Manga	4	3
	Katari	4	2
	Kewali	4	—
	Carried over	20	10

Group	Variety		No. of buds planted	No. of plants examined
	Brought forward ..		20	10
MUNGO ..	Kuswar	4	2
	Rangol	4	—
	Matanwar	4	1
	Pararia	4	—
PANSAHI ..	Sanachi	4	4
	Kahu	4	2
	Lata	4	2
	Maneria	4	—
	Pansahi	4	—
SARETHA ..	Katha	4	3
	Lalri	4	1
	Kansar	4	3
	Dhaur Saretha	4	2
	Khari	4	3
	Hullu Kabbu	4	4
	TOTAL	80	37

NOTE.—Sunnabile group was left out because of great variation in its components.

The main details of this paper are found in the Memoir “ Studies in Indian Sugarcanes, No. 2,” page 138.

The buds were planted in tile pots with a lateral hole as seen in Plate XXII, fig. 1, and the angle of the main shoot was measured by means of an instrument (Plate XXII, figs. 2 and 3), being a copy of the one in use at the Paddy Breeding Station under the control of the Government Economic Botanist, Mr. F. R. Parnell. The observations were commenced on the 15th day from planting and continued to the 87th day, when it had to be discontinued, as it was felt that the tile pots were too small to keep the plants any further in a healthy condition. A more extended series, with the plants growing in big sized pots, is being laid to enable a continuation of this study up to the harvest of the canes. Each day two observations were recorded, one in the morning at 8 a.m., and another in the evening at 3 p.m., but as little difference was noticed between the two observations on the same day, only the morning observations were taken for study.

The curves in Chart I were plotted from the bi-weekly averages of the daily angles of the varieties in that group. Note the great

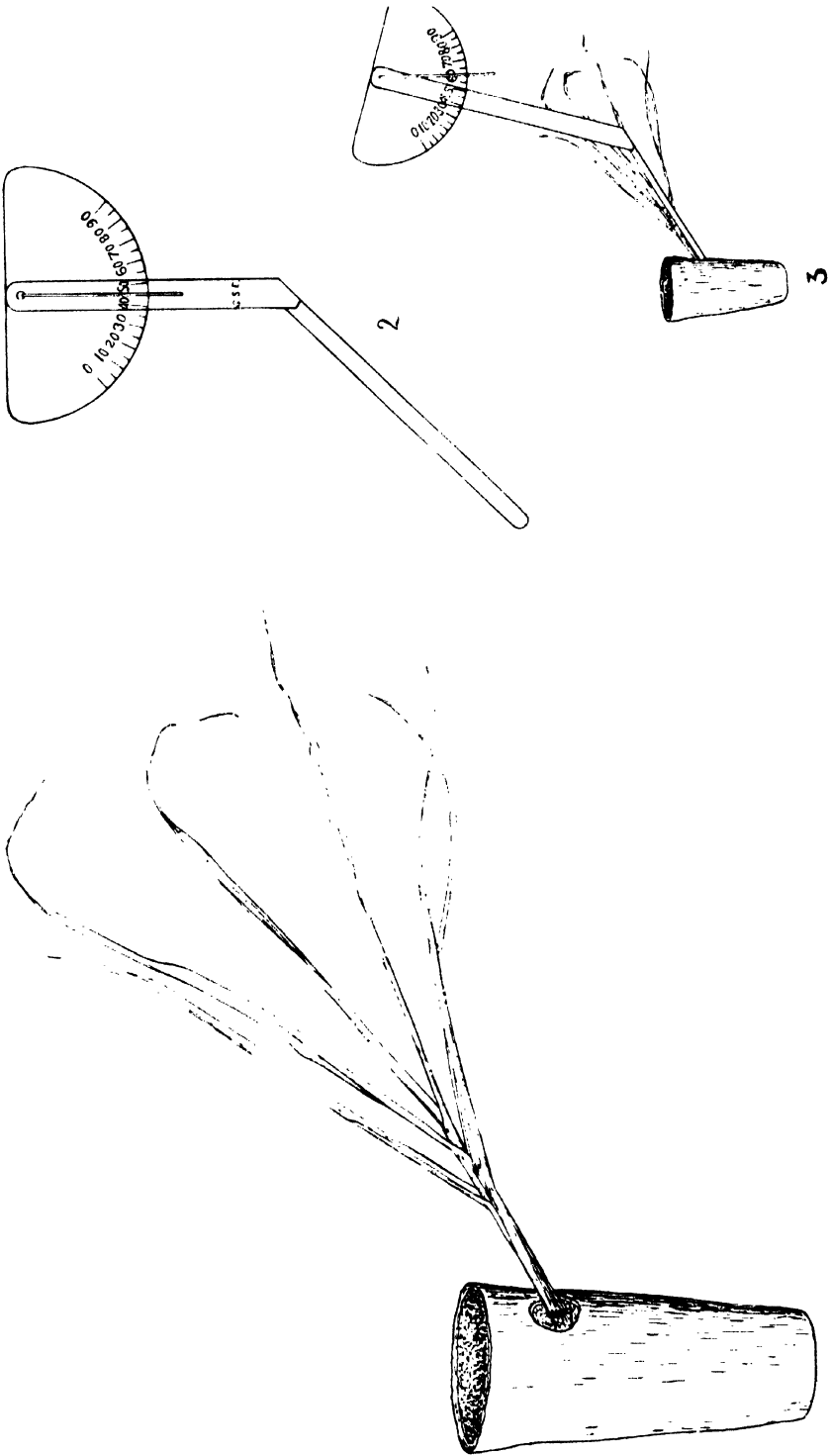

1 Sugarcane buds planted in a tile pot with a lateral hole Nos. 2 and 3 show the instrument used for measuring the angle of the main shoot.

Curves showing the position of the main shoot with reference to the vertical from 15th to 87th day after planting

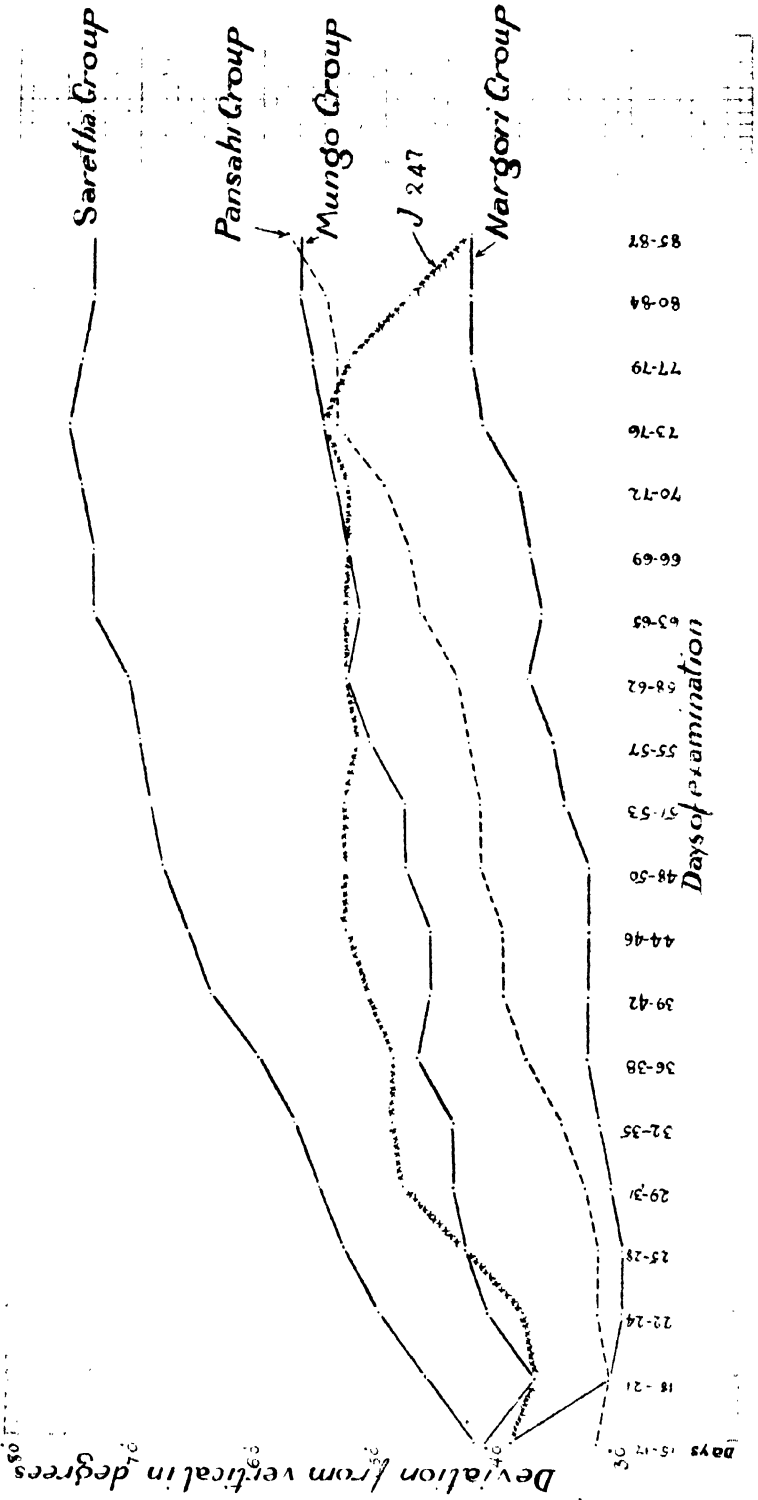

Showing deviation of the main shoot from vertical during the course of expt

Deviation at
Start (---) Finish (—)

Range of
deviation

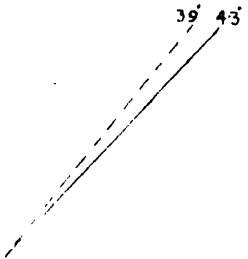

J 2 47

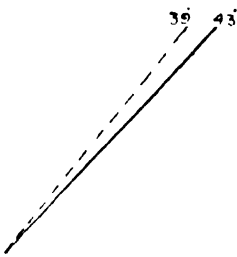
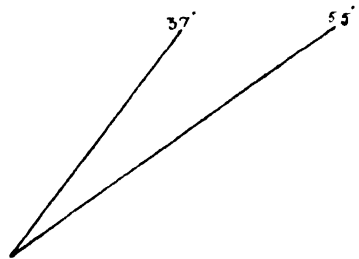

Nargori Grp

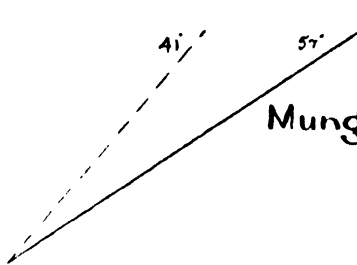
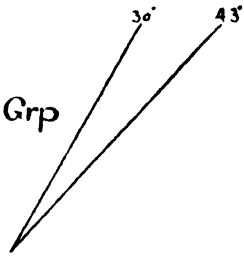

Mungo Grp

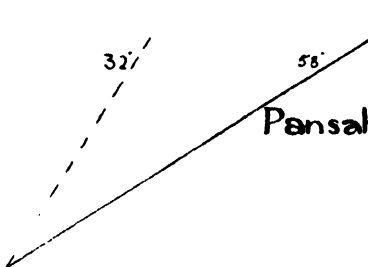
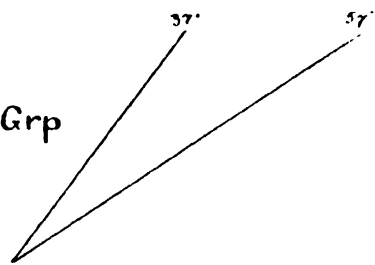

Pansahi Grp

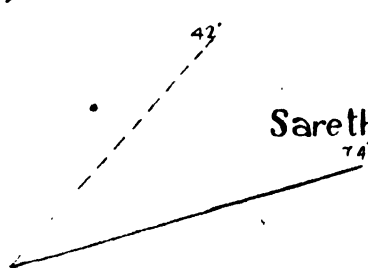
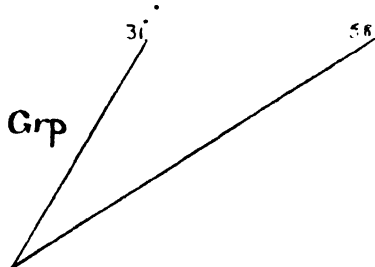

Saretha Grp

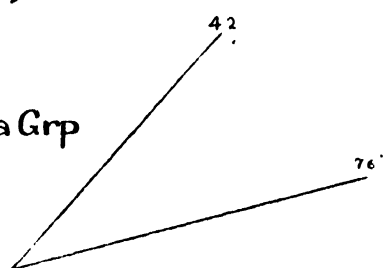

dissimilarity between the curve for the Saretha group and those for the other groups which have a comparatively good habit at harvest.

Chart II shows the angles as noted at the start and at the end of the experiment for each group and the range of variation noted for the different groups during the course of the experiment.

It is interesting to note that, in Nargori group, which has probably the best habit of all the indigenous canes, the angle of deviation is the least, and Saretha group, the worst habited of the indigenous canes, shows not only the greatest range, but is distinctly worse than the others, both at the start and at the completion of the experiment.

STRAIGHTNESS OF CANES AT HARVEST IN THE DIFFERENT GROUPS OF INDIGENOUS CANES.

For some time the straightness of canes at the time of harvest has been recorded at the Sugarcane Breeding Station. Besides detailed notes on the relative straightness of early or late canes, 100 canes of each variety used to be laid on the ground and a general note recorded on the lot as a whole. Detailed notes are available, but they fall roughly into three classes, *viz.*, (1) straight, *i.e.*, with little or no curvature anywhere; (2) slightly curved, *i.e.*, showing a slight curving at the top or the base; and (3) curved.

The table on next page gives the number of varieties classed under the three heads during the years 1917 and 1919 when the crop was grown in the same field. In the year 1918 the canes were badly lodged and so the notes are not reliable.

Erectness of varieties at harvest.

Group	Year	STRAIGHT					SLIGHTLY CURVED					CURVED			Average for 1917 and 1919 %	
		Straight	Straight below and slight curved above	Total	%	Average for 1917 and 1919 %	Straight below curved above	Slight curved	Slight curved below and curved above	Total	%	Average for 1917 and 1919	(Curved)	Total		%
J. 247 ..	1917	1	..	1	100.0
	1919	1	..	1	100.0
Nargori ..	1917	14	..	14	82.4	..	3	3
	1919	6	9	15	88.2	1	1	2	14.7
Mungo ..	1917	32	..	32	97.0	..	1	1
	1919	30	3	33	91.7	..	3	3	5.6
Pansahi ..	1917	10	1	11	73.3	4	..	4
	1919	7	3	10	52.7	5	4	9	37.0
Saretha ..	1917	..	1	1	4.3	..	13	13	9	9	39.1	..
	1919	1	..	1	4.3	..	8	8	45.7	14	14	60.9	50.0	..



Fig. 1. Nargori group showing good habit.



Fig. 2 Mungo group showing good habit



Fig 1. Pansahi group showing very fair habit.



Fig. 2. Saretha group showing bad habit with canes sprawling on the ground.

J. 247, Nargori and Mungo groups which show comparatively little variation in angles in the growth of the main shoot show a large number of varieties with straight canes. Saretha group is the worst and Pansahi group occupies an intermediate position. (Plates XXIII and XXIV.)

THE INHERITANCE OF HABIT IN SUGARCANE SEEDLINGS AND ATTEMPTS TO IMPROVE IT BY CROSSING.

Bad habit, in a seedling bred for North India, was early realized to be a possible evil to combat with and, if possible, eliminate, and attempts were made even from the start to collect data to determine the mode of inheritance of this character among the seedlings raised from the same parentage. One of the most startling facts, brought out from the raising of canes from seed, is the great diversity that is noticeable in seedlings raised from one and the same parent, and this may be said to form the main basis on which the production of a seedling better than the parent depends.

But through all this diversity in the resultant offspring there is often traceable a certain amount of broad similarity among the seedlings of one and the same parent; and this similarity often expressed itself in the form of a similar habit among seedlings of the same parent.

From the tables below it is seen that whereas the seedlings of the Saretha group (Plate XXV) show a particularly bad habit similar to that of the parent, those of the Sunnabile group, for instance, show a better habit agreeably to the better habit of the parents.

Inheritance of bad habit in seedlings of Saretha group.

Year	Seedlings	No. planted	Good habit	Fair habit	Bad habit	REMARKS
1914-16	Saretha G. C.	500	7.7	28.5	63.8	
	Do. Self	200	7.2	30.1	62.7	
1915-17	Katha	100	17.8	53.4	28.8	Rather ill-grown.
	Kansar	100	16.9	40.5	42.6	Do.
	Lalri	100	22.8	38.6	38.6	Do.
	Mesangen	100	15.3	47.0	38.7	Do.
	Saretha	100	4.5	58.4	37.1	Do.
1917-19	Ramui G. C.	100	8.3	25.0	66.7	

*Inheritance of good habit in seedlings of thick canes and
Sunnabile group.*

Year	Seedlings	No. planted	Good habit	Fair habit	Bad habit	REMARKS
1915-17	Red ribbon G. C.	100	39.0	45.7	15.3	Parent has good habit and a thick cane.
1917-19	J. 247	200	45.3	48.0	6.7	Do. do.
	Putli Khajee	100	14.3	79.6	6.1	Parent habit fair, belongs to Sunnabile group.

It is however fortunate that by a suitable crossing it is found possible to influence the habit of the resultant seedlings. The table hereunder shows that the habit in seedlings is, to some extent, controllable by proper selection of the pollinating parent, though it should here be mentioned that the peculiarities of the sugarcane flowers makes it impossible to attempt this improvement of habit in all cases.

Influence of crossing on habit.

Year	Parentage	No. of seedlings planted	Good habit	Fair habit	Bad habit	REMARKS
1916-18..	Mauritius 1237 ×		%	%	%	
	M. 4694 ♂	200	75.5	21.6	2.9	M. 4694 habit good
	Mauritius 1237 ×					
	M. 7319 ♂	50	75.0	25.0	..	M. 7319 habit good.
	Mauritius 1237 ×					
	Saretha ×	150	39.0	51.7	9.3	Sar × Spt. bad habit.
	S. Spt. ♂					
1917-19..	J. 213 × Java ♂	140	1.1	75.3	23.6	Java fair habit.
	(Hebbal)					
	Do. × Purple					
	Mauritius ♂	100	0.0	70.6	29.4	P. Mauritius fair habit.
	Do. × Katha ♂	100	0.0	47.1	52.9	Katha bad habit.
	Do. × Kansar ♂	100	2.6	50.0	47.4	Kansar bad habit.
	Do. × Saretha ♂	100	0.0	40.7	59.3	Saretha bad habit.

Note.—Mother Mauritius 1237 has a good habit but it gave no selfed seedling because of infertility of its own pollen.

J. 213 has fair habit but it gave no selfed seedlings because of infertility of its own pollen.

My thanks are due to Rao Sahib T. S. Venkatraman, B.A., Acting Government Sugarcane Expert, for giving me all facilities and encouragement.

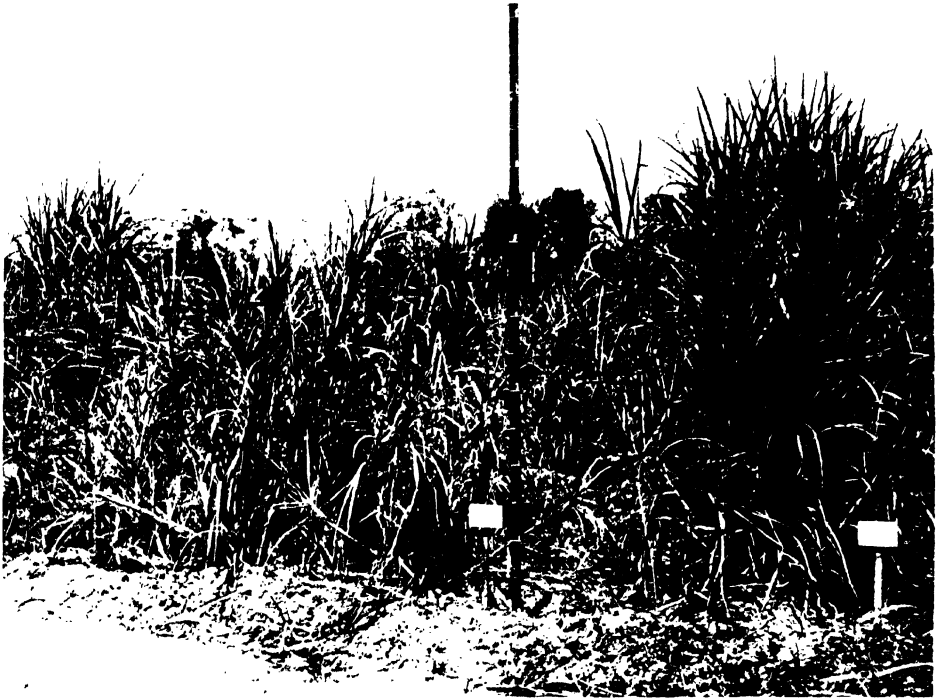

Fig. 1. Katha and its seedlings. Note bad habit in both.



Fig. 2. Pansahi and its seedlings. Note the good habit.

Selected Articles

THE GROWTH OF THE SUGARCANE.*

BY

C. A. BARBER, C.I.E., Sc.D., F.L.S.

III.

THE presence of roots and shoots on the joints of the cane at crop time is, as we have seen, unwelcome. The new growths are of course useless for sugar making, and their presence in quantity lowers the purity of the juice at the mill. Besides this, all the joints in the neighbourhood of lateral shoots have a good deal of their stored sucrose changed into glucose, which is the form in which sugar travels to supply the material for fresh growing parts. We traced the formation of shoots and roots to climatic causes, chief among which was an excess of moisture, to lodging, to any check in the growth of the cane, whether by insect or fungus attack or accidental breakage, or, lastly, to the canes flowering some months before harvest time. We also noted that some varieties of cane are more prone to shooting than others. It is a very common phenomenon in diseased plants. In some cases the habit and general appearance of the bunch is entirely changed, and, in place of a few upright, clean canes, hundreds of small, grass-like shoots make their appearance (Fig. 1). This abnormality is apparently due to the most various causes. It is supposed to be induced by various insects and fungi, by eelworms in the roots, general malnutrition, and the presence of alkali in the soil ; but it is often impossible

* Reprinted from the *International Sugar Journal*, December 1919.

to fix the responsibility on any one circumstance. It will be remembered that it is one of the features of the mysterious *sereh* disease which devastated the Java cane fields towards the end of the last century. The writer has met with a case in India where in a couple of acres, planted with cane for the first time, and in apparently ideal surroundings, after 14 months' growth only an

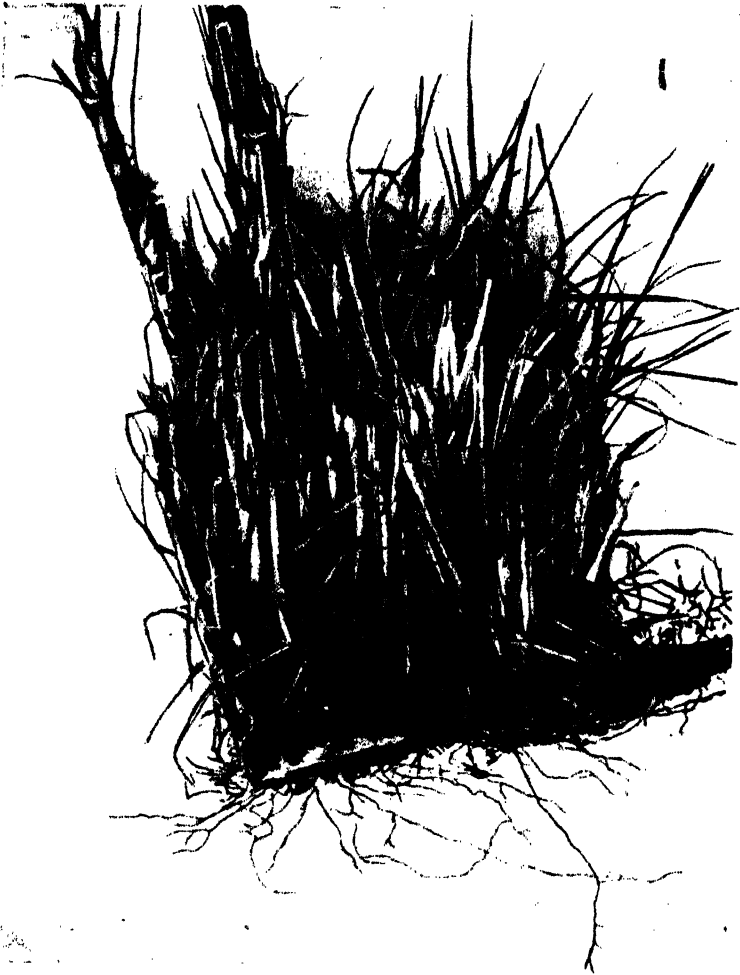

Fig. 1. A plant with many small shoots in place of a few healthy canes.

occasional isolated cane could be seen, and the whole field looked very much like one of *Guinea grass*. A thorough examination of

the tissues of the affected plants, both above and below ground, showed no sign of unhealthiness or any trace of insect, fungus or eelworm. The subject requires further study to determine the fundamental condition of the plant's economy which leads to this enormous development of shoots, which is in many respects similar to the "spike" disease of sandalwood.

But to resume our main study of sugarcane growth. To properly understand this under field conditions, it is necessary to examine the constitution of the bunch of canes derived from a single planted set, and this is especially the case when we come to consider the tillering power of different varieties. We have seen that the piece of cane planted has several joints, and that each of these joints has a bud which is capable of producing a complete plant. The bunch of canes in a single "hole" where one set has been planted may thus consist of one or more plants, according to the number of buds which "germinate." The number of separate plants in a bunch and their relative size and importance can only be determined by dissection. This is a tedious and difficult operation, for the lowest parts of the canes, where they are attached to their mother stems, are often thin and brittle, and furthermore, the whole underground part of the bunch is enveloped in an intricate web of tough, fibrous roots, dead and living, which have to be cut away before the details of the branching can be laid bare. An example of such dissections is shown in Figs. 2, 3, and 4. In Fig. 2 a bunch of canes has been photographed as it was lifted out of the ground, with all the soil carefully picked and washed away, but the free spread of the roots is somewhat obscured by the pressure of the bunch upon them. Upon dissection, this bunch was proved to consist of four separate plants, which are shown in Figs. 3 and 4. In these four plants there were 7, 9, 4, and 8 canes, respectively, making a total of 28 for the whole bunch. The latter was only nine months old when taken out of the ground, but experience of many dissections has shown that no shoot not already forming cane at its base at that time can develop rapidly enough to be of use in the crop, and only such have been taken into account. The result, then, of planting a single set has been that four plants

were produced, with an average of seven canes each at harvest. The bunch was of the *Mungo* group of Indian canes.



Fig. 2. A bunch of *Mungo* canes arising from a single set. This is a dwarf variety with very short joints. The root system is poorly developed and not fully shown.

There are many lessons to be learnt by thus laying bare the whole branching system of a bunch of canes. It is easily seen that the individual canes are not of the same age. Some are formed very early in the life of the plant, while others have, so to speak, been produced at the last moment, and have barely time to complete their growth by harvest. Some of the main shoots are produced by the out-growth of the buds on the set, while others are branches of branches of these. As we know from our chemical analyses that the character and richness of the juice varies a good deal during the

life of each cane, gradually increasing until an optimum is reached and then declining, it becomes necessary to carry our examination further, and determine the whole scheme of branching. In the example given above, we must determine the relative stage of development of each of the 28 canes forming the bunch, and its correct position in the scheme of branching. Assuming, as a basis, that each shoot, if it develops unhindered, will produce one cane, we may divide them into classes on completing our dissection.



Fig. 3. The bunch in text-figure 1 dissected out to show that it consists of four separate plants arising from different buds on the set. In each plant the "mother" cane is indicated by a piece of white paper wrapped round it.

The shoot which is the direct outcome of a bud on the set is the main axis of the plant: this we term the "mother" cane and designate it by the letter *a*. Shoots formed from buds on the joints of *a* are branches of the first order, and we name them *b*1, *b*2, *b*3, etc., in the order of their arrangement from below upwards. Similarly, the branches on *b* are of the second order and marked *c* and so on with *d*, *e*, etc., as far as they appear. In the bunch of canes photographed, the four plants have the following constitution:— $a + 3b + 3c$, $a + 2b + 5c + d$, $a + 2b + c$, $a + 3b + 4c$.

Taking the whole of the canes of the bunch together, we have $4a + 10b + 13c + d$, and if we made enough dissections and calculated the resulting formulæ of the different plants, we could obtain an



Fig. 4. The bunch in text-figure 1 dissected out to show that it consists of four separate plants arising from different buds on the set. In each plant the "mother" cane is indicated by a piece of white paper wrapped round it.

average constitution of a typical plant of the group. As a matter of fact, this has been done. Fifty-nine dissections were made of cane plants in the *Mungo* group, and the average formula for these 59 works out as $a + 2b + 2c + d$.

A study has recently been made of many other groups of canes¹ and the result of this shows that, while there are extreme variations in the formula of individual plants, the greater the number of dissections, the simpler the average formula becomes. In the following table some of the results of this study are summarized. In the first column the actual averages obtained in the dissections are recorded, in the second the theoretical formula of branching is put down, which, it is presumed, would be reached by the plants

¹ Barber, C. A. "Studies in Indian Canes, No. 4. Tillering or Underground Branching," *Memoirs of the Department of Agriculture in India, Botanical Series, Vol. X, No. 2, June 1919.*

if they had been grown in more ideal surroundings. It is obvious that, for this kind of study, all the varieties had to be grown under uniform conditions side by side in one place. And, as the place chosen was in many cases far removed from their natural habitat, climate, and soil, they did not grow as well as they were capable of doing. The dissections were made at the Coimbatore Cane-breeding Station in South India:—

Formulae of branching of different groups of canes.

Group of canes	Number of plants dissected	Average of dissections						Theoretical formula					
		a	b	c	d	e	f	a	b	c	d	e	f
(1) Wild grasses— <i>Saccharum arundinaceum</i>	5	1	4	6	6	5	0.4	1	4	6	6	4	1
<i>Saccharum spontaneum</i>	17	1	4	7	5	2	0.4	1	4	6	6	4	1
(2) Indian canes— <i>Pansahi</i> group	29	1	3	4	2	1	3	4	3	1	..
<i>Mungo</i> "	59	1	2	2	1*	1	2	3	2	1	..
<i>Saretha</i> "	53	1	3	3	1	1	3	3	1
<i>Nargori</i> "	33	1	3	3	1	3	3	1
<i>Sunnabile</i> "	46	1	3	2	1	3	3	1
(3) Thick, tropical canes grown in India	41	1	2	1	1	2	1

* The formula for the *Mungo* group is reduced here because the varieties are dwarf canes with very short joints; there are, therefore, more plants in a hole than in the other cases. As many as 7–11 plants were sometimes included in a bunch, and the branching of these was consequently small. By using another method the actual average obtained was 1, 3, 3, 2.

We learn from this piece of work that there is a good deal of difference in the branching powers of different groups of canes. The wild *Saccharums* head the list, and, as the cultivated canes (*Saccharum officinarum*) must have arisen from a wild ancestor, the former have been included. The branching of the wild *Saccharums* is the most prolific. The indigenous Indian canes come next, and can be roughly divided into two sets. *Pansahi* and *Mungo* branch a great deal, *Nargori* and *Sunnabile* much less wherever they are grown. *Saretha* in its native habitat (the Punjab and adjoining portions of the United Provinces, where tropical canes cannot, as a rule, mature) would belong rather to the *Pansahi-Mungo* set, although the dissections show a formula similar to that in *Nargori-Sunnabile*. Lastly, the thick, tropical canes branch least. It is a matter of common observation that their tillering

power is much less than that of Indian canes, and this is clearly brought out in the table. It should, however, be stated that the tropical canes grown on the farm were no more at home than the North Indian varieties. It would be difficult to find a place which suits both of these classes of cane plants. A set of 12 bunches of well-grown tropical canes was dissected on an estate in South Arcot, where they are grown successfully on a large scale for sugar manufacture. They belonged to the Red Mauritius variety, which is known as a free tillerer, and the object aimed at was to determine the possible branching of thick canes grown on an estate scale in India. The average of these 12 selected bunches gave the formula $1a + 3b + 3c + 1d$, and this may, perhaps, be a more general formula for canes grown in the various sugar growing countries in the tropics. It may be of interest, in conclusion, to point out that the Yuba cane of Natal, a member of the *Pansahi* group of Indian canes, was one of those included in the dissections. A good deal of attention is just now being paid to this hardy, primitive variety, and the extended formula of its branching system is undoubtedly one of its main attractions.

NOTE ON THE EXHAUSTION OF INDIAN SOILS AND THE
METHODS BY WHICH THIS MAY BE REMEDIED.*

BY

R. V. NORRIS, D.Sc.,

Government Agricultural Chemist, Madras.

As a result partly of war conditions and of the shortage of grain stuffs resulting from the failure of the monsoon a year ago a good deal of attention has recently been paid to the present condition of Indian soils and the crop-yields obtained from these. The results of such investigations have tended on all sides to demonstrate that a very serious impoverishment of these soils is taking place and that energetic steps are necessary to remedy this state of affairs.

Let us consider for a moment the changes taking place in the soils. We know that the various plant foods, nitrogen, phosphates, potash, etc., may exist in the soil in a number of different forms. Some of these will be present as compounds which are of immediate use to the crop, others require to undergo various transformations before they can be taken up by the plant. The former class we describe as the "available" plant food, the latter as the "unavailable." The second term is of course a relative one, because, as I have explained, a certain proportion of the unavailable material slowly undergoes change and becomes available. Now how does this influence the crop? It is obvious of course that while there is a plentiful supply of available plant food the soil will be fertile and other conditions being favourable good crop-yields will be

* Paper read at the Madras Agricultural Conference, 1919. Reprinted from the *Journal of the Madras Agricultural Students' Union*, December 1919.

obtained. If this food supply however is not maintained by the addition of appropriate manures there will be a regular falling off in yield until eventually a state of balance is reached when the plant food removed in any given crop is equal to the amount of unavailable food rendered available during the time of growth. The yield obtained under such circumstances is of course very low and we refer to it as the "minimum cropping value of the soil." Owing to the relatively large reserves of plant food present in practically all soils, this low figure will remain practically unchanged for very prolonged periods. I have gone into these very elementary details of soil chemistry with which most of you are entirely familiar because it is sometimes argued that since many Indian soils go on producing year after year a fairly constant yield there is really little cause for anxiety. You will readily see that such an argument is fallacious. It simply means a very large proportion of these soils have already reached this minimum cropping value which I have just described, that is to say they are producing year after year crops far below those which could be raised after reasonable manurial treatment.

Now to meet the shortage of food stuffs to which I have already referred, there has been a vigorous demand in many quarters for the adoption of more intensive methods of cultivation and for the introduction of heavier yielding strains. Now both of these are eminently desirable things, but it is necessary we should realize one result of their adoption. It is perfectly obvious of course that the introduction of more prolific strains means we shall remove plant food from the soil at an increased rate. Similarly by more intensive measures of cultivation we shall increase the rate at which our reserve plant foods are brought into use and lead in this way to a more rapid depletion of our stocks. In other words, both these methods alone while giving us a momentary greater return will, unless accompanied by proper manurial treatment, eventually lead only to a still greater exhaustion of the soil and the final yield will again fall to the minimum value. The more intensive our methods therefore and the more prolific the strains we employ, the more imperative is the necessity for an extended and judicious use

of fertilizers. It is obvious that these fertilizers must be used in a systematic and rational method. If a soil is deficient in both nitrogen and phosphate such a soil will derive but little benefit from the application of nitrogen alone as the crop would still be limited by the phosphate deficiency. We may say then that usually general manures will be required, prolonged treatment with a manure containing one particular type of plant food only leading to a more rapid exhaustion of the other forms of plant food and hence ultimately to a reduction of fertility.

It is probably not generally realized to what extent soil exhaustion in India has already proceeded, so I may give one or two figures to illustrate the point.

In Madras we have during the last few years been engaged in a soil survey of the paddy lands of the Presidency and up to the present time have completed such a survey in four of the chief deltas, namely, Guntur, Tanjore, Kistna, and Godaveri. This survey has had as one of its principal objects merely to ascertain how far these soils are in need of immediate manurial treatment. The results are certainly instructive. Considering first the Godaveri Delta, which is generally considered to contain some of the most fertile land in the Presidency, we find nevertheless that 23 per cent. of the samples analysed show a deficiency in available phosphate and 40 per cent. or nearly half the delta a deficiency in nitrogen content.

The Kistna Delta gives slightly worse figures, 33 per cent. of the samples exhibiting phosphate starvation and 55 per cent. lack of nitrogen.

In the remaining two deltas the situation is even more serious, the figures being as follows:—

				Deficient in nitrogen	Deficient in phosphate
				Per cent.	Per cent.
Guntur	::	::	::	81	33
Tanjore	::	::	::	87	80

Comment on such figures is hardly necessary and there is no reason to believe that many of the other paddy lands of the

Presidency are in any better condition. If we remember that an increase of 5 per cent. only in the average yield would provide an extra 1,000,000 tons of rice a year in Madras alone, we can realize to some extent what the annual loss is in the whole country in this and other crops.

Examples such as the above could be brought forward in numbers. Clouston, in a paper read at the Indian Science Congress in 1918, stated that the four chief soils of the Central Provinces had in most districts reached a state of maximum impoverishment. In one of his experiments by an outlay of Rs. 33 per acre on manures in cane, the net profit per acre was increased by no less than Rs. 146, *i.e.*, over 400 per cent. the cost of the manure applied. In a similar way Davis has emphasized the critical condition of many of the Bihar soils as regards phosphoric acid content.

We may then, I think, take it as a fact that a very large number of Indian soils are already exhausted or approaching that state. We must pass on to consider what are the chief requirements of such soils and the reasons why under present conditions these requirements, urgent as they are, are being met to such a small extent.

In the examples I have quoted, we have seen that the deficiency chiefly consists of nitrogen and phosphates and this may on the whole be considered as applicable to the whole of India though certain districts—of which the Nilgiris and Malabar are examples,—are also extremely deficient in lime. Let us consider first of all the nitrogen question. Now nitrogen, like other plant foods, exists in the soil in available and non-available forms, the most available form, nitrates, being produced from complex nitrogenous compounds in the soil by a series of changes terminating in nitrification. Sometimes however these changes take another course and in this way an accumulation of relatively unavailable nitrogenous material may take place of which a familiar example is the production of peat. By cultivation we produce conditions, however, which are favourable to nitrification. One result therefore of the intensive cultivation to which I have already referred will be to accelerate this conversion of unavailable nitrogenous material into nitrates, and unless appropriate measures are taken, the reserves being

used up at a rapid rate, exhaustion will occur. Such cultivation moreover has another disadvantage. It is well known that under suitable conditions very large quantities of nitrogen can be added to the soil from the atmosphere by the agency of nitrogen-assimilating bacteria. But these bacteria require the presence in the soil of considerable amounts of carbonaceous organic matter. Hence if by our intense cultivation we use up at a rapid pace this organic matter in the soil we shall thereby at the same time diminish this valuable fixation of nitrogen.

It is obvious therefore that we must combine such methods of cultivation with liberal supply of manure, and for the reasons I have stated, bulky organic manures such as farmyard manure, *poonacs* and fish manure are peculiarly suitable to the conditions prevailing in this country. Such manures moreover have a further advantage as compared with more concentrated manures in that they improve to a marked degree the mechanical condition of the soil whereas the concentrated chemical manures have a tendency in the opposite direction.

It is particularly unfortunate therefore that the manures to which I have referred are precisely those which for various reasons are either being sent out of the country or else used in a wasteful manner. In the first place, the best use is not made of the manure most generally available, *viz.*, farmyard manure. In many districts this is used mainly as fuel resulting in a total loss of nitrogen. Even if this be not done the manure is almost invariably stored in such a way that at least 60 per cent. of the nitrogen is not utilized. Little effort is made to collect the liquid and more valuable portion of the manure or to protect the manure pit in any way, with the result that the aggregate loss in manurial value is enormous.

There is no doubt that many ryots at present do not realize the value of manures. This is a factor which time alone can remove but the ryot is a shrewd judge in many ways, and when once convinced by demonstration of the benefits to be derived he will not be slow to take up the use of manures. This has been shown in a striking way by the largely increased demand for fish guano even in districts remote from the source of supply. But assuming that

the ryot is fully convinced of the value of manure and anxious to obtain these, the price of most fertilizers has reached a figure which puts them quite out of reach of the small cultivator except in the case of the most profitable crops. The reason for this is the high price which manures such as oil-cakes and fish command in the foreign market resulting in a large export trade and a rise of price in this country.

Fish manure containing as it does a good percentage of both nitrogen and phosphate is particularly suitable to our soils and yet the export is increasing rapidly. In February of this year Colombo was paying Rs. 160 per ton for fish guano and consequently was attracting the bulk of this commodity which a year or so before was obtainable at Rs. 45 a ton ex-factory. This export is likely to continue, therefore, with a consequent increase in price in spite of the fact that the production of fish manure is necessarily limited and quite insufficient to meet the manurial requirements of the country.

When we come to consider the case of oil-cakes we find again exactly the same conditions prevailing. These cakes, though they contain sometimes a fair amount of phosphate, must be regarded chiefly as nitrogenous manure. Now the oil-seed crops are notoriously exhausting to the soil. But if the seeds were crushed and the resulting cake either applied to the land directly or in the form of cattle manure after feeding, there would at least be some return of plant food to the soil. But the tendency is all the other way. Not only has the export of oil-seeds steadily increased, but even in those cases where the seeds have been crushed in this country a large amount of cake is exported. The figures are instructive. Taking the normal years immediately preceding the war, the export figures for the whole of India were approximately as follows:—

1913-14	ALL INDIA			Tons	Value £
	Whole oil-seeds	1,572,792	17,000,000
	Oil-cakes	175,000	1,000,000
	FROM MADRAS ALONE.				
	Oil-seeds	3,500,000
	Oil-cakes	400,000
					(approximately).

This has naturally led to a great increase in cost and the state of affairs is likely to become worse owing to the intense demand for such products at the present time in European countries. Hence it is not surprising to find that the present price of groundnut cake is about Rs. 140 per ton or three times the price for which it could be obtained a very few years ago. It is impossible for the average ryot to pay such prices and it is in my opinion essential that steps should be taken to remedy this state of affairs. It would therefore appear necessary to prohibit entirely the export of fish manure of which the supply is so limited and to impose an export tax on oil-cakes in order to retain a large quantity of these in the country. With regard to whole oil-seeds also a heavy export tax should be imposed. In this way the oil-crushing industry could be developed in India, the oil being freely exported but the residual cake being consumed as far as required in this country. Two causes have hitherto tended to retard the development of oil-crushing in this country. The fact was that when oil-crushing was introduced, owing to the wholesale adulteration which took place Indian oils obtained a thoroughly bad reputation. Secondly, European countries have imposed an import duty on oil while allowing free entry to whole seeds and cake. The remedy for the first is obvious ; in regard to the second, the conditions in Europe are such that it is doubtful whether these duties would be maintained if the supply of whole seed were restricted. Hence the times are now particularly favourable for such a change.

So far we have been considering nitrogenous manures. In the case of phosphates the situation is much the same. The chief phosphatic manures available in this country are bones, fish manure, and deposits of mineral phosphate. With fish we have already dealt. In the case of bones we again find a large export taking place. Owing to the war, the figures for the last few years have been erratic, but in normal times bones to the value of over 4 lakhs of rupees were annually exported from this Presidency alone chiefly to Ceylon. As a result of this external demand the price has steadily risen and early this year the excessively high figure of Rs. 130 per ton was being quoted in Ceylon for bone meal. This is therefore another

case where export should be totally prohibited. The bones retained in this way could readily be crushed at a large number of centres because many land owners are already in possession of oil engines which are not fully employed and which could therefore be used with advantage to drive small disintegrators. In this way bone meal, which has given good results in this country, would be available at a greatly reduced cost.

In the case of mineral phosphate deposits in this country we are at present in some doubt as to the best method of utilization. They are not suitable for the preparation of superphosphate and when used alone the availability is of a very low order. A considerable number of experiments have been carried out here to increase their availability by using the crushed mineral phosphate in combination with organic matter. The experiments have been sufficiently successful to indicate that a satisfactory method of utilizing these deposits will probably be found, but it cannot be said that the correct conditions have yet been realized.

Quite recently claims have been put forward regarding a phosphatic manure termed "tetra phosphate" which is prepared in a very simple way from rock phosphate. These experiments have been carried out chiefly in Italy and in my opinion the evidence is not particularly convincing. In view of the importance of utilizing our supply of phosphate we are, however, at present carrying out trials to test this new method on the Trichinopoly deposits, but the experiments are not yet sufficiently advanced to indicate the probable result.

One other possibility has lately arisen in connection with such deposits. Very favourable results have been obtained in America by the use of ammonium phosphate. Such a fertilizer, containing as it does about 13 per cent. of ammonia and 40 per cent. of soluble phosphate, would probably be particularly suitable for the conditions prevailing in South Indian soils. The possibility of utilizing the Trichinopoly deposits in such a way depends entirely on the cost of production and this will again depend largely on the production of cheap ammonia which is quite a feasible proposal in this country. At any rate the prospect opens out a promising field of enquiry.

While dealing with future possibilities I may also refer to the use of what is known as "activated sludge," which is the final deposit obtained in the most recent method of sewage disposal. The substance when dry contains about 6-7 per cent. of nitrogen instead of the 1-2 per cent. in the older product and may eventually therefore form a valuable manure in the neighbourhood of large towns where such a system will sooner or later will have to be adopted.

We dealt so far with the indigenous manures of the country and we must finally consider how far we can make use of synthetic methods for utilizing the nitrogen of the atmosphere to make nitrogenous fertilizers. There are three or four ways in which this is now being done in other countries. First, there is the Arc method in which by means of a powerful electric arc the oxygen and nitrogen of the atmosphere are made to combine to form nitric acid. This requires very high powers and large production to be profitable and will not, I think, be practically suitable for Indian conditions. Secondly, we have the Haber process for synthetic ammonia by which hydrogen under the influence of a catalyst is made to combine with atmospheric nitrogen to form ammonia which can then either be converted into ammonia sulphate or further oxidized to nitric acid. This is one of the cheapest ways of producing ammonia and enormous quantities of ammonium sulphate are now being manufactured in this way so that there is a considerable likelihood of a considerable fall in price as regards this fertilizer. This probability is increased by the report recently published of an important improvement on this process which will considerably reduce the cost of production. The process, however, requires skilful supervision and will not therefore be particularly easy to establish in this country. Lastly, there is the cyanamide process in which atmospheric nitrogen is passed over heated calcium carbide with the formation of calcium cyanamide, a valuable nitrogenous fertilizer, which is also easily capable of conversion into ammonia. The requisite materials for this process are supplies of limestone, fairly pure charcoal and reasonably cheap electric power and it is likely to be the best adapted for use in this country.

There is no doubt ample scope and opportunities for the development of such industries in India. Not only are the fertilizers produced of the greatest value in themselves but they could be used in combination with *poonacs* of poor quality such as *pinnai* or *dupake* cake which at present can be profitably used alone.

It may be remarked in passing that a new nitrogenous fertilizer has recently received much attention, *viz.*, ammonium nitrate, which was largely used in the war as a constituent of explosives. The advantage of this compound is that it contains nearly 35 per cent. of nitrogen and so is the most concentrated nitrogenous manure made, a factor of value where transport has to be considered.

I hope I have now been able to show that it is possible by the methods indicated, *viz.*, restriction of export of *poonacs*, uncrushed oil-seeds, bones and fish manures and by the development of the processes for the synthetic production of nitrogenous manures, to reduce very considerably the price of manures in this country. I have only time to refer very briefly to the other measures necessary to ensure the best use of the materials thus made available. The first necessity is the further education of the ryot. As I indicated, this is not so difficult as sometimes supposed and machinery already exists for such work and only requires expansion.

Secondly, the cost of transport must be reduced to a lower figure. Hence co-operative purchasing is indicated in order that manures may as far as possible be carried in bulk with consequent reduction in freightage rates. For similar reasons purchase in bulk is necessary in order to obtain favourable terms, and this means credit must be provided. There is therefore a large field here for the development of co-operation.

Finally, there is the difficulty, and it is no small one, of the present system of land tenure in many parts of the country. So insecure is the position of the tenant that he cannot reasonably be expected to sink capital in improvements from which he himself may obtain but little benefit and for which, if evicted, he can claim no compensation.

The whole question therefore is by no means a simple one but the time is quickly approaching when it will have to be faced in a

reasonable manner. The population is increasing rapidly and I believe that the enhanced production required can only be brought about by a determined effort to increase the *permanent* fertility of the soil by reasonable manurial treatment. At present there is a tendency to face it in another way by the attempt to bring into cultivation large areas of more or less unprofitable land, but judged only from the point of view of production this can have but little permanent value and cannot be regarded as anything but a palliative of a temporary nature.

SUMMARY.

The situation may then be summed up briefly as follows :—

1. A large proportion of the soils of the country are already suffering from starvation or are approaching that state.

2. The supply of indigenous manurial products is being sent out of the country at an increasing rate with the result that the price is now prohibitive to the small cultivator.

3. Such a deficiency must be met by (a) limitation of export of such materials ; (b) increased production of synthetic nitrogenous manures, in which methods based on the cyanamide process would appear to be most likely of success in this country ; (c) development of processes for the utilization of the phosphatic deposits of the country.

4. In order to utilize the increased supply of manurial substances, attention must be directed to (a) education of the ryot to realize their value ; (b) development of co-operative buying and transport ; (c) revision of land tenures where these do not give the tenant a sufficient margin of protection.

THE POSSIBILITIES OF CITRUS CULTURE IN INDIA.*

BY

A. H. WITTLE,

Of "Orchard Deve," Yercaud.

MUCH interest has been awakened in recent years in the cultivation of fruit and the production of articles of consumption previously imported. There is no doubt that, if the subject was better understood and the knowledge properly applied, the greater proportion of the money paid to outside producers might be kept in the country, not only to the material economic advantage of India, but also from a health point of view.

India—and I may even confine my statement to apply to the Madras Presidency—with its varying altitudes and climate is, in my opinion, as near as possible, ideal for the cultivation of almost every known variety of fruit, and what with the ever improving economic position of the majority of Indians, combined with Government assistance in opening up an experimental jam and preserve factory on the Nilgiris, there is, and always will be, a growing demand for really well-grown fruit.

At the present time, demand is undoubtedly outpacing the supply.

Apart from the urgent need for fresh fruit, there is also a growing demand for preserves, cool drinks, etc., such as marmalade, candied-citrus peel, raw and sweet lime juice, citric acid, crystals for mineral waters, and citrate of lime which is used in its crude form for bleaching certain kinds of linen. Also other bye-products,

* Paper read at the Madras Agricultural Conference, 1910. Reprinted from the *Journal of the Madras Agricultural Students' Union*, December 1919.

which, owing to simple methods of manufacture, could easily be made in this country by any intelligent ryot, after receiving a few lessons from an expert of the Agricultural Department, and it is my good fortune to know how keen the officials of the Agricultural Department are, in every branch, to help one and to give valuable advice merely for the asking.

What with cheap labour, combined with a few simple and effective appliances for cultivation, and given facilities for irrigation where necessary, and average good land—such as is met with more or less all over the country—with an addition of fertilizers intelligently applied, we should not only be capable of producing enough first class fruit for our own requirements, but could compete most favourably with other exporting countries on the European markets.

The most suitable places in South India for citrus culture would be parts of the Nilgiris, Sheveroys, Kunnamalais and many other hills, the Malabar Coast, Wynad and, in fact, almost anywhere where there is good soil and ample rainfall, say, from 60 to 120 inches average, or where irrigation is available.

Citrus fruits do best in a deep, loamy soil rich in humus and the essential plant foods, but it has been my experience that almost any soil can be made to grow good, healthy fruit trees; with proper preparation of the soil before planting and what with cheap labour and suitable implements, which are available in the country at present, it is not a very difficult or expensive matter to bring some of the most intractable and apparently indifferent looking soil into a fit state to grow excellent fruit trees. It is merely a matter of thoroughly working, and in some cases, sub-soiling, draining, and ploughing in one or two green manure crops and adding suitable fertilizers, and the trees—other things being equal—will not only grow well, but very soon bear paying crops.

Now to the question of the right kind of plants to propagate or purchase:—Cheap trees, merely because they are cheap, usually prove to be the most expensive in the long run; therefore, purchase your trees from a reliable nurseryman and pay him a fair price for the very best trees he can produce. You may be told that two

or three year old plants; such as one sees in nurserymen's show gardens, and which are usually covered more or less with fungi of sorts, trying to grow in a 6-inch flower-pot, will make excellent growth when planted out, and will bear fruit in one or two years. These plants are sold at a low price and are usually not worth paying freight on. It is more economical to pay a good price for really well-grown healthy plants free from leaf and other diseases and also guaranteed true to name and thus avoid the possible dissemination of virulent plant diseases. It is to be hoped, now that the Pest Act is in force, Government will consider the necessity of inspecting plants offered for sale in every nursery in the country, and no one should be allowed to sell plants to the public without first obtaining an annual certificate of cleanliness from an authorized Government expert. I know a case where a man spent a considerable amount of money on citrus plants which were covered with a most destructive fungus disease and, had it not been that he procured advice, and had not the plants been properly treated in time, he would have lost the whole of them and, worse still, would have given up in despair an enterprise which has since proved a most remunerative undertaking, thinking that either the climate or soil was unsuitable.

As regards suitable varieties, there are many, and, on looking through a catalogue, one is often bewildered by the host of varieties named, all—or nearly all—of which appear to have special merits. As India is the home of citrus tribe, it would be as well to consider the best of those usually grown in the locality, such as the Nagpur *santara* orange, the Sylhet, and in South India, especially in Coorg, that which has come to be known locally as the Coorg orange, are perhaps three of the best. Of imported varieties, there are Washington Navel, Navelensia, Mediterranean Sweet, Paper rind, St. Michael Joppa, and Valencia late—to mention only a few of the best; there is Seville orange (*C. vulgaris*) and sometimes called *C. bigardia* or bitter orange, which is used extensively in the manufacture of marmalade and also for the extraction of essential oil from the rind, leaves and flowers, which is used as a base in the manufacture of some of the most expensive perfumes and also for

the manufacture of citrate of lime from the juice. A sample taken from this variety growing locally was found to contain 9 oz. of citric acid crystals per gallon of juice.

The citron (*C. medica* sp.), the rind of which is used in the manufacture of the candied peel of commerce, and for which there is a large demand. Juice of this fruit also has been tested and found to contain over 7½ oz. of citric acid per gallon of juice.

The Pomelo (*C. decumana*), which is sometimes called the Shaddock, grape fruit, etc. Apparently there are three varieties of this fruit grown in South India, although none of them could by any stretch of imagination be considered to resemble a grape in taste. There is no doubt, however, that there is more than one variety of this fruit which is really delicious when prepared by extracting the bitter membrane and sprinkling the pulp with sugar. I have it on the authority of an expert in such matters that it is a delicious and refreshing fruit to eat early in the morning. There is no doubt that if this fruit with its vigour, deep-rooting system, and enormous bearing qualities was extensively grown and the taste for it acquired, there would be an enormous demand at remunerative prices, and it probably would become as well known and appreciated in India as it is in Europe and America at the present time.

The lime (*C. medica* var. *acida*) of which there are at least three distinct kinds, viz., thorny, thornless, and seedless. If possible, the thornless variety should be chosen for general cultivation owing to the convenient way in which pruning, gathering the fruit, and general cultivation can be carried out, and this applies especially in India, where the labourers generally work bare-footed. If, however, a thorny variety be planted, the inconvenience of the thorns can, to a great extent, be overcome by careful handling at pruning time, by having some kind of cart, handled between the lines in which all prunings are thrown, and this will probably pay for doing, in view of the fact that, so far as is known at present, the thorny gives the highest percentage of citric acid. There does not appear to be any appreciable difference between the thorny and seedless varieties in this respect.

It is found, where limes are grown on a large scale, that the citric acid content of the juice varies considerably with the rainfall, that is, in a wet climate or season the acid content is low, whereas during dry weather, or where the average rainfall is small, the acid content is high, the variation being from 10 oz. per gallon in the wet weather to 14 oz. in dry weather—tests in the West Indies. In June of this year, after trees growing in Yercaud had passed through a very severe dry weather, the juice tested as high as $21\frac{1}{2}$ oz. per gallon, whereas in December, after a long spell of wet weather, the test gave only 10 oz. to the gallon. At the same time, the variation in such figures may be more apparent than real, as fruit may contain more juice in a wet season than in a dry one, and it is quite possible that, although the percentage of citric acid per gallon may be lower in wet weather, the probable extra amount of juice will compensate, or perhaps more than compensate, for the higher percentage in dry weather fruit. Although the different kinds of lime in general cultivation do not appear to vary greatly either in acid content or the amount of juice per given weight of fruit, this is a point which appears to lend itself to very useful research work, both on the line of natural selection, and possibly through budding selected plants on to vigorous stocks, with a view to improve not only the yield of acid content, but also the improvement in quality and quantity of the essential oil in the rind, and this is a point well worth considering before planting out on a large scale, the main issues being the citric acid percentage, quantity of juice and essential oil obtainable per acre. And I cannot find that, up to the present, this subject has seriously been studied in a scientific manner. It is obvious that one acre of limes giving an average of, say, 2,000 fruits per tree of 10 oz. acid content is more profitable than one giving 200 per tree of the same sized fruit giving 10 oz. acid per gallon.

You will now naturally want to know the possible returns from citrus fruit growing, and this is a point on which I fear much controversy will arise, and to avoid the possibility of misunderstanding which may lead a prospective planter astray and cause him to invest his capital without a full knowledge of the subject,

I will say at once that other things being equal—much, in fact everything, depends on the individual. At the same time, there is no reason why any one interested in fruit culture should go astray when really sound advice can be easily obtained from the Agricultural Department, and—strange as it may seem—I have much more faith in the eagle eye of an entomologist or mycologist than in a painted *chatti* which one sometimes sees erected on a pole to ward off the evil eye. As there is now no excuse for any one going astray on this point, I will give you some figures which may encourage some one to have a flutter at what I consider to be a paying proposition. To begin on the safe side, I cannot, I think, do better than quote figures which I gave to a fruit-planter who obtained my advice some time ago in connection with his orange trees, which consisted chiefly of Mandarines, Washington Navel, Navelia, St. Michael, Mediterranean Sweet, and Lemons; these figures refer to 9-year old trees which were allowed to overbear in the fourth year and suffered, not only in consequence of this but also from neglect of the ordinary practices of cultivation for the remaining five years and they were in anything but good condition. I estimated that given proper cultivation and pruning, each tree should give an average of 5 dozen perfect fruits the same season, which, considering the excellent varieties and the advantageous market conditions, would have sold at 8 annas per dozen or Rs. 2-8-0 per tree, and this on over 700 trees, or roughly 7 acres, or say, Rs. 250 an acre. Allowing Rs. 100 an acre for cultivation, manure, etc., and cost of marketing the crop, it would have left Rs. 150 an acre clear. Had those trees been properly cared for and Rs. 100 an acre spent annually on cultivation, pruning and manure, they would have, at 9-year old, given considerably over 500 fruits per tree, and this is what I consider to be a fair average crop on well-cared-for trees under general Indian conditions for oranges, lemons, citrons, etc. Limes of course bear much heavier crops, and, owing to their being planted 15' × 15' apart which would allow them ample room even on the best of soils and give 193 trees per acre, I have seen trees which gave an annual crop of between three and five thousand limes of good size. As to the prices obtainable for fruit in different

districts, much depends on the market facilities on each plantation ; it is impossible to give anything like an accurate statement as to possible profits in each district. But the figures I have given will, I think, enable any one interested in the subject to form a fair idea on this point. Unfortunately I am unable to go into details of the manufacture and sale prices, etc., of citric acid in such a short paper as this must be. There are other aspects of citrus culture, such as the preservation of fruit by the sweating process and allied subjects, which, I fear, must be left out of this paper, also through lack of time. As it is, I am afraid I have overstepped the time limit and trust you will excuse the prolonged babbling of an enthusiast.

BRITISH CROP PRODUCTION.*

BY

DR. EDWARD J. RUSSELL, F.R.S.

CROP PRODUCTION in Britain is carried on in the hope of gain, and thus differs fundamentally from gardening, which is commonly practised without regard to profit and loss accounts. Many poets from times of old down to our own days have sung of the pleasures to be derived from gardening. But only once in the history of literature have the pleasures of farming been sung, and that was nearly two thousand years ago.

Ah ! too fortunate the husbandmen, did they but know it, on whom, far from the clash of arms, earth their most just mistress lavishes from the soil a plenteous subsistence.—“Georgics,” Bk. II., i, 458 *et seq.*

“Did they but know it” ! Even then there seem to have been worries !

This seeking for profit imposes an important condition on British agriculture : maximum production must be secured at the minimum of cost. This condition is best fulfilled by utilizing to the full all the natural advantages and obviating so far as possible all the natural disadvantages of the farm—in other words, by growing crops specially adapted to the local conditions, and avoiding any not particularly well suited to them.

From the scientific point of view the problem thus becomes a study in adaptation, and we shall find a considerable interplay of factors, inasmuch as both natural conditions and crop can be somewhat altered so as the better to suit each other.

It is not my province to discuss the methods by which plant-breeders alter plants ; it is sufficient to know that this can be done

* Discourse delivered at the Royal Institution in February 1920. Reprinted from *Nature*, dated the 8th April, 1920.

within limits which no one would yet attempt to define. The natural conditions are determined broadly by climate and by soil. The climate may be regarded as uncontrollable. "What can't be cured must be endured." The scheme of crop production must, therefore, be adapted to the climate, and especially to the rainfall.

The rainfall map shows that the eastern half of England is, on the whole, drier than the western half. In agricultural experience, wheat flourishes best in dry conditions and grass in wet conditions; the vegetation maps show that wheat tends to be grown in the eastern and grass in the western part. The strict relationship is that seed production is appropriate to the drier, and leaf production to the wetter, districts.

The great soil belts of England south of the Trent run in a south-westerly direction; north of the Trent, however, they run north and south. A heavy soil, like a wet climate, favours grass production; a light soil, like a dry climate, is suitable for arable crops. The great influence of climate is modified, but not overridden, by the soil factor.

The arable farmer grows three kinds of crops: corn, clover or seeds hay, and fodder crops for his animals or potatoes for human beings. The same general principles underlie all, and as corn crops are of the most general interest (though not necessarily of the greatest importance) they will serve to illustrate all the points it is necessary to bring out. We have seen that wheat is cultivated more in the eastern than in the western portion of the country. The figures for consumption and production are as follows:—

Millions of tons per annum.

		Consumption in United Kingdom	Production in England and Wales			Production in United Kingdom		
			Before war 1914	1918	1919	Before war 1914	1918	1919
Wheat	..	7.40	1.6	2.3	1.8	1.7	2.6	2.0
Barley	..	1.96	1.2	1.2	1.1	1.6	1.5	1.3
Oats	..	4.30	1.4	2.0	1.6	3.0	4.5	4.2

During the war very serious attention was paid to the problem of reducing the gap between consumption and production. A working solution was found by lowering the milling standard, retaining more of the offal, and introducing other cereals and potatoes; a very considerable proportion of the resulting bread was thus produced at home. But the war-bread did not commend itself, and disappeared soon after the armistice; since then the consumption of wheat has gone up, and the divergence between consumption and production has again become marked. There is no hope of reducing consumption; we must, therefore, increase production. Additional production may be obtained in two ways: by increasing the yield per acre, and by increasing the number of acres devoted to the crop.

The yield per acre is shown in the following table:—

Measured bushels per acre.

	(1908-17) Average yield per acre		A good farmer expects	Highest recorded yield
	England and Wales	Scotland		
Wheat ..	31·0	39·9	40 to 50	96
Barley ..	31·9	35·4	40 to 60	80
Oats ..	39·3	38·9	60 to 80	121

Unfortunately the terms “bushel” and “quarter” (8 bushels) lack definiteness, being used officially in three different senses and unofficially in several others also. The following are some of the definitions of a bushel:—

	Official statistics. A definite volume having the following average weight	Corn Returns Act. Volume occupied by following weight	Grain Prices Order. Volume occupied by following weight	Frequent practice. Volume occupied by following weight
	lb.	lb.	lb.	lb.
Wheat ..	61·9	60	63	63
Barley ..	53·7	50	55	56
Oats ..	39·3	39	42	42

The average results include bad farmers and bad seasons ; the good farmer expects to do considerably better, but he has many things in his favour : superior knowledge, greater command of capital, and possession of good land ; he will, therefore, always stand above the average. Even his results can be improved ; the highest recorded yields show what can be done with present varieties and present methods in exceptionally favourable circumstances. The figures give the measure of the scientific problem, which is to discover what changes would be necessary in order to bridge the enormous gap between the average and the best. In three directions progress is possible : we may modify the plant, or the soil, or we may mitigate the effects of unfavourable climate.

Before the soil can be brought into cultivation at all it is necessary to carry out certain major operations—draining, enclosing, etc.,—which have to be maintained in full order. These lie outside our present discussion ; we must assume that they are properly carried out, which is by no means always the case. Given adequate drainage, soil conditions are profoundly modified by cultivation, which has developed into a fine art in England and Scotland, and is, indeed, far better practised here than in most other countries. But it is an art, and not yet a science ; the husbandman achieves the results, but no one can yet state in exact terms precisely what has happened. A beginning has been made, and a laboratory for the study of soil physics has been instituted at Rothamsted and placed under Mr. B. A. Keen, where we hope gradually to develop a science of cultivation. For the present cultivation remains an art, and, further, it is essentially a modern art. The medieval implements, as shown in the Tiberius MS. (eleventh century) and the Luttrell Psalter (fourteenth century), were crude, and left the ground in an exceedingly rough condition. Great advances were made throughout the nineteenth century. Robert Ransome, of Ipswich, took out his first patent in 1785 to improve the plough ; he was followed in 1812 by Howard, of Bedford, and later by Crosskill, Marshall, Rushton, Fowler, and others, who have made British implement makers famous throughout the world. Given time and sufficient labour

the good British farmer using modern implements can accomplish wonders in the way of cultivation.

Unfortunately, neither time nor labour is always available. Ploughing is possible only under certain weather conditions, and there are many days in our winters when it cannot be carried out. Unless, therefore, a large staff of men and horses is kept, the work often cannot be done in time to allow of sowing under the best conditions.

The early days of the life of a plant play almost as important a part in its subsequent history as they do in the case of a child. Illustrations are only too numerous of the adverse effect of being just too late for good soil conditions. One from our own fields is as follows :—

Work completed	Seed sown	Yield of wheat 1916 Bushels per acre
Just in time	Nov. 24, 1915	26·8
Just too late	Feb. 17, 1916	19·3

The farm-horse will not be speeded up, but maintains an even pace of $2\frac{1}{2}$ miles per hour. According to the old ploughman's song still surviving in our villages, an acre a day is the proper rate :—

We've all ploughed an acre, I'll swear and I'll vow,
For we're all jolly fellows that follow the plough.

But under modern conditions it is impossible to get more than three-quarters of an acre a day ploughed on heavy land, and the scarcity of teams threatened to bring arable husbandry into a hopeless *impasse*. Fortunately for agriculture, the internal-combustion engine appeared on the farm at a critical moment in the shape of the tractor, and has brought the promise of a way out. The tractor has two important advantages over the horse. First of all, it works more quickly. Its pace is $3\frac{1}{2}$ miles per hour instead of $2\frac{1}{2}$ miles. It turns three furrows at a time instead of one only ; on our land it ploughs an acre in four hours instead of taking nearly a day and a half as required by horses. There is no limit to the work it can do ; even an acre an hour is no wild dream,

but may yet be accomplished. It therefore enables the farmer to get well forward with his ploughing during the fine weather in late summer and early autumn, and thus to obtain the great advantages of a partial fallow and of freedom to sow at any desired time. On our own land our experience has been as follows:—

Dates of completion of sowings of wheat and oats.

Year	Wheat	Oats	
1916	February 17 ..	October 16 ..	} Horses only. Tractor.
1917	March 16 ..	" 17 ..	
1918	January 26 ..	" 27 ..	
1919	November 26 ..	" 5 ..	

Further, if the plough is correctly designed and properly used, the tractor does the work fully as well as horses—even the horse-ploughman admits that. It therefore increases considerably the efficiency of the labourer, which, as we shall see later on, might advantageously be raised. The cost of working is apparently less, though it is difficult to decide this until one knows what the repairs bill will be. In our case the cost is:—

Cost of ploughing per acre, Autumn, 1919.

	By tractor	By horses
	<i>s. d.</i>	<i>s. d.</i>
Labour	7 7	10 2
Maintenance	—	22 6
Oil and petrol	7 8	—
Depreciation and repairs	6 3	—
	21 6	32 8
Time taken ..	4 hours	1½ days

The internal-combustion engine is only just at the beginning of its career on the farm, and no one can yet foresee its developments. It is being used at present simply like a horse, and is attached to implements evolved to suit the horse. But it is not a

horse ; its proper purpose is to cause rotation while it is being used to pull, and in some cases, indeed, this pull is reconverted into rotary motion.

The second great method of improving soil conditions is to add manures and fertilizers. Farmyard manure is more effective than any other single substance ; it is likely to remain the most important manure, and if available in sufficient quantity it would generally meet the case. Realizing its importance, Lord Elveden generously provided funds for extended investigations at Rothamsted into the conditions to be observed in making and storing it. This work is still going on, and is leading to some highly important developments.

Farmyard manure, however, is not available in sufficient quantities to meet all requirements. The chemist has long since come to the aid of the farmer ; he has discovered the precise substances needed for the nutrition of the plant, and prepared them on a large scale. Like cultivation, this is largely a British development ; it was in London that the first artificial manure factory was established in 1842, and for many years the industry was centred in this country. The fertilizers now available are as follows :—

Nitrogenous. Nitrate of soda, nitrate of lime, sulphate of ammonia, and cyanamide (nitrolim).

Phosphatic. Superphosphate, basic slag, mineral phosphate, guano, and bones.

Potassic. Sulphate of potash, muriate of potash and kainit.

Agricultural chemists have worked out the proper combinations for particular crops, and obtained many striking results.

Without using any farmyard manure they have maintained, and even increased, the yield of corn crops, fodder crops, and hay ; and in the two latter cases there has been an increase, not only in yield, but also in feeding value per ton. In spite of seventy years' experience there is still much to be learned about the proper use of artificial fertilizers, and they may still bring about even fuller yields from the land.

The yield of corn crops can be increased by artificial fertilizers, but not indefinitely ; the limit is set by the strength of the straw.

As the plant becomes bigger and bigger, so the strain on the straw increases, until finally when the plant is some 5 ft. high, it cannot stand up against the wind, but is blown down.

Little is known about the strength of straw. It is a property inherent in the plant itself, and differs in the different varieties. It is affected by the season, being greater in some years than in others. It is affected also by soil conditions. At present the strength of the straw is the wall against which the agricultural improver is pulled up. The problem can undoubtedly be solved, and the plant-breeder and soil-investigator between them may reasonably hope to find the solution.

Another great effect of artificial fertilizers which has not yet been fully exploited is to mitigate the ill-effects of adverse climatic conditions. Phosphates help to counteract the harmful influence of cold, wet weather; potassic fertilizers help the plant in dry conditions. The combination of a suitable variety with an appropriate scheme of manuring is capable of bringing about considerable improvement in crop production.

A demonstration with the oat crop on these lines was arranged last year in a wet moorland district and the crops when seen in August were as follows :

			Estimated crop Bushels	
Local variety, local treatment	27	Harvest late.
Local variety, phosphatic manuring	45-54	„ earlier.
Special variety "Yielder," phosphatic manuring	54-66	} „ earlier. stands up well.

The potato crop is governed by the same general principles as corn crops. It furnishes more food per acre than any other crop, but it is much more expensive to produce, and therefore is grown chiefly in districts where the conditions are particularly well suited to it: the Fens, Lincolnshire, the plains of Lancashire, and the Lothians, though smaller quantities are grown in almost every

part of the country. The production and consumption are as follows :—

Potatoes : Annual production and consumption.

CONSUMPTION	PRODUCTION					
	In England and Wales			In United Kingdom		
6·5 millions of acres	Pre-war			Pre-war		
	1914	1918	1919	1914	1918	1919
	3·00	4·20	2·70	7·50	9·20	6·30
	0·46	0·63	0·48	1·20	1·51	1·22

We are thus self-supporting in the matter of potatoes. We do, however, import about half a million tons per annum of early and other potatoes ; we also export seed potatoes and some for food—in all, about one million tons per annum.

(To be continued.)

Notes

CONTRIBUTIONS FOR AGRICULTURAL INVESTIGATIONS.

THE Trustees of the Sir Sassoon David Trust Fund have made the following grants to the Bombay Department of Agriculture :—

1. A contribution of Rs. 6,666 per annum for three years for the investigation of the insect diseases of *jowar* (*Andropogon Sorghum*) and their methods of control.

2. A contribution of Rs. 5,000 per annum for three years for the investigation of methods of improving poor grazing lands under Deccan conditions.

3. A contribution of Rs. 5,000 per annum for three years for the investigation of the eradication of the most serious weeds of cultivation, and especially of *lavala* (*Cyperus rotundus*).

4. A contribution of Rs. 6,666 per annum for three years for the investigation of drought-resisting, high-yielding varieties of food crops, and especially of *bajri* (*Pennisetum typhoideum*).

5. A contribution of Rs. 2,000 per annum for three years for the study of the deterioration of cardamoms in the spice gardens of Kanara.

6. A contribution of Rs. 3,333 per annum for three years for the study of the economic efficiency of agricultural implements in Western India, and its increase.

7. A contribution of Rs. 5,000 for the investigation of the difficulties of potato cultivation in the Deccan.

8. A contribution of Rs. 10,000 towards the cost of buildings for the rice experimental station at Karjat (Kolaba District, Bombay Presidency).

THE ORIENTATION OF THE BANANA INFLORESCENCE.

THERE has always been a vague belief among banana growers that the orientation of the banana inflorescence is a thing that can be controlled. It was thought that the said inflorescence would appear either on the side of the plant where the cut surface of the corm is found or on the exactly opposite side. No scientific evidence for the belief existed.

The evidence given below tends to show that the inflorescence appears on the side opposite to the cut surface of the corm from which it springs.

In July 1919 the writer superintended the planting of an area of bananas in the Ganeshkhind Botanical Garden. This area measures $1\frac{1}{2}$ acres and contains 550 plants mainly of *Sonkel* and *Rajapuri* varieties. All corms were planted in the same way, namely, with the cut side facing north. It was hoped thus to protect the bunches from the southern sun, if the bunches came out on the north side.

After three or four months all trees showed a slight inclination to the southern side. In the beginning of March 1920 many of the trees of the *Rajapuri* variety began to bear. In every case so far the inflorescence is toward the south.

The inclination of the trees toward the south gave the writer an idea and he hastened to test it by digging out the soil and exposing the roots of a couple of trees. In both the trees examined it was found that the cut surface of the corm had produced no roots, but that the roots were produced along the border of the cut surface. Roots are, however, produced freely from the rest of the corm. This absence of roots from a great portion of one side of the corm means less firm anchoring on that side. As the tree sways with the wind it is conceivable that there is a gradual tendency to bend away from the weakly anchored side. The banana inflorescence, when it appears, will, by the force of gravity, bend over to that side towards which the stem is already leaning.

The number of trees now bearing is 64, and all the inflorescences are bent towards the south. If all the others bend in the

same manner it would seem that there is some ground for the writer's theory, namely, that the bending away from the side of the cut is simply due to imperfect anchoring in the soil.

It is of course possible that this bending, all in one direction, may be due to some factor in the environment. This doubt can be removed by planting the corms so that each row has the cut surface opposite that of the next row. This would bring the inflorescences facing one another in every two rows if the writer's theory is true.

If the theory proves to be true, advantage can be taken of it to plant corms so that the inflorescence and the fruits will not suffer from the sun, or to plant them so that the bunches face one another between the rows and so can be easily watched.—[P. G. DANL.]

* * *

**A NOTE ON *HELIOTHIS (CHLORIDEA) OBSOLETA*, Fb.,
AS A PEST OF COTTON.**

DURING the course of investigation into the bionomics and incidence of *Pectinophora gossypiella* now being carried on at Coimbatore we were surprised to discover *Heliothis obsoleta*, Fb., was engaged in committing more havoc than *Earias fabia*, *Earias insulana* and *Pectinophora gossypiella* put together. As far as the writer is aware this is the first record of *Heliothis obsoleta* appearing on cotton in pest conditions. In America and in Africa it is a regular pest of cotton, but so far does not appear to have damaged this crop in India.

At the time when most damage was being done, and the damage was considerable, not only was there about 15 acres of Bengal gram (*Cicer arietinum*) on the farm, but next to one of the attacked fields were some tobacco plants in seed. These latter were not touched. The gram crop was almost a total loss. Cambodia cotton appeared to suffer rather more than *Uppam* or *Kurangunni* although the latter varieties were in the next field to the gram field.

The *Heliothis obsoleta* larvæ feed on the young green bolls of the Cambodia both from the outside, according to their usual habit when attacking gram, and also at times entered entirely into

the boll and stayed there until they had eaten the entire contents. At other times a U-shaped tunnel would be driven through the boll. In other cases again the outer rind would be nibbled and then left. In nearly every case where the boll had been entered, a boll attacked meant a boll destroyed, unlike *P. gossypiella* which does not always damage the whole boll. It was observed that before beginning to attack a boll, *H. obsoleta* larvæ would often spin a few threads of silk between the boll and the bracts. At first these threads were attributed to spiders until the time when larvæ were seen at work spinning them.

There is no doubt that if this change of habit (as far as India is concerned) on the part of *H. obsoleta* were persisted in, it would be a far more dangerous pest than either *Earias* or *Pectinophora*.

The attack was first noticed early in January and by the end of February all larvæ had disappeared. A table is given below showing the amount of damage done. This table does not take into account the bolls and buds attacked and fallen to the ground as no trace of these could be kept. The bolls examined did not come from one field but from several fields at different places on the Central Farm.

It may be noted that one consignment of green bolls from Pollachi, distant some 30 miles from Coimbatore, also showed that *H. obsoleta* was present in pest conditions.

No. of bolls examined	Date	PERCENTAGE DAMAGED			REMARKS
		P.	E.	H.	
* 2,000 ..	10-1-20	45.5	2.50	6.50	6.5% of the bolls destroyed.
2,000 ..	17-1-20	1.1	?	1.80	
2,000 j ..	24-1-20	0.5	0.65	1.10	Increase of flowers and buds.
2,000 ..	31-1-20	0.3	0.45	3.75	
2,000 ..	7-2-20	0.4	0.40	3.20	
1,000 ..	14-2-20	0.6	0.60	3.00	
1,000 ..	21-2-20	1.0	2.10	0.50	
1,000 ..	28-2-20	1.2	1.10	nil	

P. — *Pectinophora gossypiella*.

E. — *Earias* sp. *fabia* and *insulana*.

H. — *Heliothis obsoleta*.

* Percentage of H. to E. and to P.

The usual plants attacked by *H. obsoleta* in South India are red gram (*Cajanus indicus*), Bengal gram (*Cicer arietinum*), groundnut (*Arachis hypogæa*), tomato, maize, cholam (*Andropogon Sorghum*), tobacco, *Cannabis sativa*, linseed, safflower, lablab (*Dolichos lablab*).—[E. BALLARD.]

* * *

PLANT HYGIENE.

INCREASING INTEREST is being taken by farmers and commercial fruit and vegetable growers in science as applied to cultivation. Both old established societies—content in the past with their practical knowledge of crop cultivation—and newly formed societies—eager to base their operations on scientific lines—are asking for lecturers who can demonstrate to them the advantages of the combination of theory and practice. The Ministry welcome such requests, and are endeavouring to meet them as far as possible.

In the middle of January a lecture was delivered in Norwich by Mr. G. C. Gough, B.Sc., an Inspector of the Ministry, on the subject, "Plant Hygiene in Relation to Crops." Mr. Gough first pointed out that *cleanliness* is as important to plants as to human beings, and gave instances of the large losses sustained in this and other countries from the depredations of the pests and diseases of plants and crops.

With regard to measures of control, the lecturer considered the subject under the four headings:—(1) Exclusion, (2) Protection, (3) Eradication, (4) Immunization. Under the first of these he dealt with the necessity of suitable crop rotation, whereby the succession on the same land of crops subject to the same pest was avoided; the advantages of reasonable separation when planting patches of such crops as bush fruit, in view of the possibility of epidemic outbreaks of disease; and the need for care in the purchase of seed, bushes or fruit-tree stocks to avoid the introduction of disease. Mr. Gough emphasized the large extent to which nurseries and seed firms are involved in this question, and in pointing out that the grower deserves every assistance to obtain clean and

good material, he foreshadowed the probability of legislation to deal with this aspect of the matter.

Under the heading of *protection*, the lecturer drew attention to the necessity of proper watering and ventilation for crops under glass, and the advantages of spraying and of soil sterilization as an insurance against the attacks of insects, fungi, etc.

It is difficult to draw a line between measures of protection and of eradication, and certain measures included by the lecturer under the latter heading apply equally to the former. Under whatever heading they are included, they constitute some of the most important precepts of plant hygiene, and the danger was emphasized (1) of permitting the rubbish heap to become the manure heap, and thus the breeding place of obnoxious plant pests, and (2) of feeding pigs and other animals on diseased food plants that had not been boiled. The lecturer pointed out that the passage of fungus spores unharmed, through the digestive system of animals, entailed their return to the land under conditions extremely favourable to the vigorous recurrence of disease.

Referring to the question of *pruning*, the lecturer urged its importance from the point of view of the removal of diseased wood, as well as from the purely cultural standpoint, and pointed out that to prune away diseased material without also burning it was but labour in vain. Mr. Gough also spoke at some length on the value of contact and poison insecticides and of the winter washing of fruit trees.

Of all matters relative to plant hygiene, the breeding of varieties immune from disease presents, perhaps, the largest field to the scientific investigator. The lecturer demonstrated by reference to those varieties of potato immune from wart disease that absolute immunity is an established fact; he pointed out the desirability of breeding varieties of crops immune from all the diseases to which they are at present liable, and also of combining this general immunity with good cropping and feeding qualities.

While it would be unwise to lose sight of the necessity of careful drainage, cultivation, manuring, etc., in the raising of healthy crops, attention to the measures outlined by Mr. Gough will be of

increasing benefit to the grower and to the nation.—[*Journal of the Ministry of Agriculture*, March 1920.]

*
*
*

NEW SOURCE OF ALCOHOL.

MUCH ATTENTION has been given in recent years to the question of manufacturing alcohol within the Empire for use as motor spirit. In Vol. XVII, No. 3 (July–September 1919), of the Bulletin of the Imperial Institute, the possibility of utilizing the *mowra* (*Bassia latifolia*) flowers of India for the purpose is discussed. These flowers possess thick, juicy petals, rich in sugar. They are used by Indians as a foodstuff and especially for the preparation by fermentation of an alcoholic liquor called *daru* or *mohwa* spirit. A single tree will yield as much as 200–300 lb. of flowers in a year. The tree also produces a valuable oil-seed, which is exported in fairly large quantities to Europe. During the war the flowers were used in India for the production of acetone, the yield being said to be ten times as much as that obtained by distilling wood, which is the usual source of this substance. The demand for acetone in India in peace times, however, is not great, and large quantities of the flowers would be available for the manufacture of alcohol, and would appear to be an exceptionally cheap source of this material as the yield is high compared with that from potatoes and other materials commonly used, about 90 gallons of 95 per cent. alcohol being obtainable from one ton of dried flowers. It has been estimated that in the Hyderabad State alone there are already sufficient *mowra* trees for the production of 700,000 gallons of proof spirit per annum, in addition to that necessary for the local liquor requirements.

It is suggested that the most profitable way of utilizing the flowers would probably be as a source of mixed motor spirit of the "natalite" type for use in India. That motor spirit can be produced on a manufacturing scale in India from *mowra* flowers has already been demonstrated, and it is stated that running trials with the spirit proved satisfactory.

SUGAR FROM THE DOUGLAS FIR.

SURPASSING in strangeness any botanical discovery made in recent times is that of a new source of sugar in the leaves of the Douglas fir, which grows in certain confined portions of the dry belt of British Columbia. Professor John Davidson, F.L.S., F.B.S.E., of the University of British Columbia, spent much time in the dry belt region for the purpose of investigating the phenomenon. He found that trees on southern and eastern exposures on gentle slopes in the dry belt region of British Columbia lying between parallels 50 and 51, and longitude 121 to 122, chiefly yielded sugar. The trees which yielded were well apart, thus receiving a good supply of sunlight on their leaves, a more plentiful supply of sunlight on their roots, and having a better air circulation through them than trees in densely forested areas.—[*Production and Export*, April 1920.]

**PERSONAL NOTES, APPOINTMENTS AND TRANSFERS,
MEETINGS AND CONFERENCES, ETC.**

HIS MAJESTY THE KING-EMPEROR'S BIRTHDAY HONOURS LIST contains the following names which will be of interest to the Agricultural Department :—

C.S.I. MR. B. P. STANDEN, C.I.E., I.C.S., Commissioner, Central Provinces and Berar (sometime Director of Agriculture, Central Provinces and Berar).

C.I.E. MR. C. M. HUTCHINSON, B.A., Imperial Agricultural Bacteriologist.

MR. W. C. RENOUF, I.C.S., Political Agent, Bahawalpur Agency, Punjab (sometime Director of Agriculture, Punjab).

* * *

DR. E. J. BUTLER, M.B., F.L.S., Imperial Mycologist and Joint Director of the Agricultural Research Institute, Pusa, has been appointed substantively *pro tempore* to be Agricultural Adviser to the Government of India and Director of the Agricultural Research Institute, Pusa, with effect from the 1st May, 1920.

* * *

MR. J. MACKENNA, M.A., C.I.E., I.C.S., on leaving Simla to take up his appointment as Development Commissioner in Burma, resigned his appointment as President of the Indian Sugar Committee, with effect from the 26th April, 1920. Mr. F. Noyce, I.C.S., has been appointed to the Presidency of the Committee with effect from the same date.

MR. W. SMITH, Assistant Director of Dairy Farms, Southern Circle, whose services have been placed at the disposal of the Department of Revenue and Agriculture, with effect from the 1st May, 1920, is appointed Imperial Dairy Expert, with effect from the same date, in the Imperial Department of Agriculture in India.

* * *

MR. G. P. HECTOR, M.A., B.Sc., Officiating Imperial Economic Botanist, has been placed, with effect from the 1st May, 1920, in charge of the current duties of the Imperial Mycologist, in addition to his own.

* * *

MR. W. WYNNE SAYER, B.A., has been appointed Supernumerary Agriculturist, with effect from the 20th January, 1919.]

* * *

DR. J. N. SEN, M.A., F.C.S., Supernumerary Agricultural Chemist, has been appointed, with effect from the afternoon of the 30th April, 1920, to act as Imperial Agricultural Chemist during the absence of Dr. W. H. Harrison on leave.

* * *

MR. N. V. JOSHI, B.A., M.Sc., L.A.G., First Assistant to the Imperial Agricultural Bacteriologist, has been appointed, with effect from the 11th April, 1920, to act as Assistant Agricultural Bacteriologist, *vice* Mr. J. H. Walton, B.A., appointed to officiate as Imperial Agricultural Bacteriologist.

* * *

MR. A. L. SHEATHER, B.Sc., M.R.C.V.S., Director and First Bacteriologist, Imperial Bacteriological Laboratory, Muktesar, has been granted privilege leave for three months and 24 days from the 17th April, 1920.

* * *

MR. W. A. POOL, M.R.C.V.S., Offg. Second Bacteriologist, has been placed in charge of the current duties of the Director and First Bacteriologist, in addition to his own, during the absence on leave of Mr. A. L. Sheather, with effect from the 17th April, 1920.

MR. A. C. DOBBS has been appointed to be substantively *pro tempore* Director of Agriculture, Bihar & Orissa, with effect from the 6th January, 1920.

* *

THE services of Mr. G. Clarke, F.I.C., Agricultural Chemist to Government, United Provinces, and Officiating Principal of the Agricultural College, Cawnpore, are placed at the disposal of the Government of India, Department of Revenue and Agriculture, with effect from the date he may be relieved of his present duties.

* *

MR. P. K. DEY, who has been appointed by His Majesty's Secretary of State for India to the Indian Agricultural Service, has been appointed to be Plant Pathologist to Government, United Provinces, with effect from the 1st March, 1920.

* *

MR. C. H. PARR, who has been appointed by His Majesty's Secretary of State for India to the Indian Agricultural Service, has been appointed to be Deputy Director of Agriculture and to be in charge of cattle-breeding, United Provinces, with effect from the 31st December, 1919.

* *

ON the completion of his training at Lyallpur, Malik Sultan Ali has been posted as Deputy Director of Agriculture, 1st Circle, Gurdaspur, with effect from the 6th April, 1920.

* *

MR. T. F. QUIRKE, M.R.C.V.S., Officer on special duty in the office of the Chief Superintendent, Civil Veterinary Department, Punjab, took charge of the duties of Officiating Chief Superintendent, Civil Veterinary Department, Punjab, with effect from the afternoon of the 22nd March, 1920, relieving Colonel J. Farmer, C.I.E., F.R.C.V.S., who proceeded on combined leave.

* *

CAPTAIN K. J. S. DOWLAND, M.R.C.V.S., Professor of Sanitary Science, Punjab Veterinary College, Lahore, assumed

charge of the duties of the Professor of Surgery, in addition to his own, on the afternoon of the 31st March, 1920, from which date Mr. E. Burke, Professor of Surgery, retired from Government service.

* * *

MR. T. M. DOYLE, M.R.C.V.S., has been appointed to the Indian Civil Veterinary Department, with effect from the 21st March, 1920, and is posted to the Government Cattle Farm, Hissar, Punjab.

* * *

MR. G. McELLAGOTT, M.R.C.V.S., has been appointed to the Indian Civil Veterinary Department, with effect from the 27th May, 1920, and is posted to Madras as Second Superintendent, Civil Veterinary Department in that Presidency.

* * *

MR. G. F. KEATINGE, C.I.E., I.C.S., on return from leave, has been appointed Director of Agriculture and of Co-operative Societies, Bombay, *vice* Dr. Harold H. Mann placed on special duty in the same office till the date of his departure on leave.

* * *

DR. H. H. MANN is granted, with effect from the date of relief, combined leave for eight months.

* * *

MR. T. F. MAIN, B.Sc., Deputy Director of Agriculture, Sind, has been allowed, by His Majesty's Secretary of State for India, an extension of furlough for six months.

* * *

MR. T. GILBERT, B.A., Deputy Director of Agriculture, Southern Division, Bombay Presidency, has been allowed, with effect from the 1st May, 1920, the amount of privilege leave due to him combined with three months' leave on urgent private affairs.

RAO SAHEB M. L. KULKARNI has been appointed to act as Deputy Director of Agriculture, Southern Division, Bombay Presidency, during the absence on leave of Mr. T. Gilbert, pending further orders.

* * *

MR. P. C. PATIL, L.AG., Deputy Director of Agriculture, Central Division, Bombay Presidency, has been allowed an extension by two weeks of the privilege leave granted to him.

* * *

MR. K. HEWLETT, O.B.E., M.R.C.V.S., has been allowed by His Majesty's Secretary of State for India an extension of commuted furlough for four months.

* * *

ON return from leave, Mr. G. Evans, M.A., C.I.E., Deputy Director of Agriculture, Central Provinces, is posted to the Northern Circle.

* * *

MR. C. P. MAYA DAS, M.A., B.Sc., Assistant Director of Agriculture, Central Provinces, is confirmed in his appointment, with effect from the 18th May, 1920, but will continue to officiate as Deputy Director of Agriculture, Western Circle, Central Provinces.

* * *

MR. R. F. STIRLING, who has been appointed by His Majesty's Secretary of State for India to the Indian Civil Veterinary Department and posted to the Central Provinces, assumed charge as Second Superintendent, Civil Veterinary Department, Central Provinces, on the 8th April, 1920.

* * *

MR. A. MCKERRAL, M.A., B.Sc., Deputy Director of Agriculture, Burma, has been granted privilege leave for six months, with effect from the 1st June, 1920, or the subsequent date on which he may avail himself of it,

COL. G. H. EVANS, C.I.E., C.B.E., M.R.C.V.S., Superintendent, Civil Veterinary Department, Burma, made over and Mr. T. Rennie, M.R.C.V.S., received charge of the duties of Second Superintendent, Civil Veterinary Department, Burma, on the 15th April, 1920. He also made over charge of the office of Third Superintendent to Mr. C. J. N. Cameron on 17th May, 1920.

Reviews

Notes on Improved Methods of Cane Cultivation.—By G. CLARKE, F.I.C.,
NAIB HUSSAIN and S. C. BANERJEE, Department of Land
Records and Agriculture, United Provinces; 1919, pp. 23+10
plates. (Allahabad : Government Press.)

THIS little volume records the results obtained at the Sugarcane Research Station, Shahjahanpur, where a large number of canes have been under trial for several years. The possibilities of intensive cultivation of improved sugarcane, selected to suit local conditions, have been dealt with at some length, and can easily be measured by the average yield of about 100 maunds of *gur* per acre obtained at the station over a number of years, as against 32.6 maunds, the average yield in the United Provinces in 1916-17, from *deshi* canes by the ordinary methods of cultivation. Besides better preparation of the land and the adoption of suitable methods of moisture conservation and soil aeration, the authors advocate the sowing of sugarcane in trenches 2 feet wide and 4 feet from centre to centre as the most suitable for thick and medium canes both as regards germination and yield per acre. To obtain a good crop by these methods of cultivation, manure containing 120 to 150 lb. of nitrogen (equivalent to about 35 to 40 maunds of castor cake) is however required. This is the heaviest item of expenditure involved, but it is definitely stated that a handsome return has always been obtained. The effect of liberally manuring the cane is not confined to that crop alone : the residual nitrogen and the deep cultivation of the trenches effect a striking increase in the yield of wheat or other crops followed by sugarcane, and, to cite an instance, in the harvest of the 1919 *rabi* crop, 36½ maunds per acre of Pusa 12 wheat were obtained over a

field of $3\frac{1}{2}$ acres, with one irrigation only. The preceding crop was Mauritius sugarcane, which yielded 948 maunds per acre or nearly three times the ordinary yield of indigenous varieties.

The intensive methods of cultivation have not, however, been so profitable with the *deshi* canes. Trials have shown that "heavy manuring with nitrogenous manure generally gives rise with *deshi* varieties to excessive vegetative growth without a proportionate formation of sucrose or crystalline cane sugar and, moreover, delays the ripening beyond the time when crushing operations are possible." The potentialities of even the best *deshi* canes in this part of the United Provinces appear to be very limited, but with deeper ploughing, application of small quantities of manure and growing pure races, the outturn can be appreciably increased.

The advantages of using small power mills, in places where central factories do not exist, are also clearly dealt with, and the rotation of crops followed at the Research Station is explained.

There can be no two opinions of the vital interest and importance of the problem of increasing the yield of sugarcane at the present time when the prices of both raw and refined sugar are ruling so high. The world's demand for sugar is continuously increasing, while its production by extension of area is not showing prospects of equal increase. The best solutions of the vexed problem of meeting the increasing demand for it seem, therefore, to lie in increasing the yield per acre by better varieties and intensive methods of cultivation, conducted with scientific skill and care, and by improved processes of manufacture. The United Provinces command about half the total area under sugarcane in British India, and there is a wide scope for introducing the improvements recommended by the authors of this volume, especially as it may now be safely assumed that at no time in the near future is the supply of *gur* or sugar likely to overtake the demand and that high prices are bound to prevail for many years to come, with a correspondingly good margin of profit to the cultivator. The successful adoption of the methods, with regard to improved canes, is, however, dependent on irrigational facilities, capital and intelligent supervision,

and will probably prove beyond the means of the ordinary cultivator ; but we hope that the wealthier cultivators and zemindars of the provinces will seriously consider the possibilities and will take the lead in bringing about these improvements which will also ultimately raise the standard of agricultural practice of the country. [EDITOR.]

* * *

Agricultural Statistics of India, 1917-18, Vol. I. Pp. 321+2 maps+9 charts. (Calcutta : Superintendent, Govt. Printing, India.) Price Rs. 2.

THIS annual volume is the thirty-fourth of the series started in 1886 with statistics for 1884-85, and has just been issued by the Department of Statistics, India. It deals with the figures relating to British India only, and, like its preceding issues, is a source of varieties of useful information for all who take an interest in agricultural questions. Statistics are usually stale ; nevertheless, a study of this volume will be profitable to many.

The actual area dealt with in this volume is 617,507,000 acres. After allowing for forests, buildings, water, roads, etc., we find that a balance of 387,799,000 acres or 63 per cent. remained available for cultivation, but the net area actually cropped during the year was 227,848,000 acres or 37 per cent. of the total area as against 229,620,000 acres in the preceding year, a decrease of 0·8 per cent. If areas cropped more than once are taken as separate areas for each crop, the gross area cropped in the year amounts to 264,817,000 acres. The area under food grains showed a decrease of 1,336,000 and that under oil-seeds of 527,000 acres as compared with the preceding year. There was an increase of 386,000 acres under sugarcane and of 1,566,000 acres under cotton, attributed chiefly to the stimulus of high prices obtained in the preceding year.

While it is admitted that the Indian figures of area are hard to beat in the matter of accuracy, the same, unfortunately, cannot be said of the figures of average and total yields. The importance of accurate agricultural statistics is, however, fully realized by the Departments of Agriculture and Statistics, and the whole question

received careful consideration of the Board of Agriculture in India held in December 1919, at which the Department of Statistics was represented by its Director. Efforts are being made to arrive at more reliable figures of yields and it may be reasonably expected that, as time goes on, they will become more and more accurate. [EDITOR.]

NEW BOOKS

ON AGRICULTURE AND ALLIED SUBJECTS

1. A Student's Book on Soils and Manures, by Dr. E. J. Russell. Second Edition, revised and enlarged. (The Cambridge Farm Institute Series.) Pp. xii+240. (Cambridge : At the University Press.) Price 6s. 6*d.* net.
2. The Fauna of British India, including Ceylon and Burma. Coleoptera. Chrysomelidæ (Hispinæ and Cassidinæ), by Prof. S. Maulik. Pp. xi+439. (London : Taylor and Francis.) Price 1 guinea.
3. Chemical Fertilizers, by S. Hoare Collins. Pp. xii+273. (London : Baillière, Tindall and Cox.) Price 10s. 6*d.*
4. Productive Sheep Husbandry, by W. C. Coffey. Pp. x+479. (Philadelphia and London : J. B. Lippincott Company.) Price 10s. 6*d.* net ; post free, United Kingdom and abroad, 11s. 3*d.*
5. Botany for Agricultural Students, by John C. Martin. Pp. x+585. (New York : John Wiley & Sons, Inc. ; London : Chapman & Hall, Ltd.) Price 12s. 6*d.* net ; post free, United Kingdom, 13s. ; abroad 13s. 6*d.*
6. Mining and Manufacture of Fertilizing Materials and their Relation to Soils, by Strauss L. Lloyd. Pp. vi+153. (New York : D. van Nostrand Company ; London : Crosby, Lockwood & Son.) Price 9s. net ; post free, United Kingdom and abroad, 9s. 4*d.*
7. Fossil Plants : A Text-book for Students of Botany and Geology, by Prof. A. C. Seward, Vol. IV : Ginkgoales, Coniferales,

Gnetales. (Cambridge Biological Series.) Pp. xiv+543. (Cambridge: At the University Press.) Price 1 guinea net.

8. **Bacteriology and Mycology of Foods**, by Dr. Fred Wilbur Tanner. Pp. vi+592+10 plates. (New York: John Wiley & Sons, Inc.; London: Chapman and Hall, Ltd.) Price 28s. net.
9. **Food: Its Composition and Preparation. A Text-book for Classes in Household Science**, by Mary T. Dowd and Jean D. Jameson. (The Wiley Technical Series.) Pp. viii+173. (New York: John Wiley and Sons, Inc.; London: Chapman and Hall, Ltd.) Price 6s. net.
10. **Chemistry and its Mysteries: The Story of What Things are Made of. Told in Simple Language**, by Charles R. Gibson. (Science for Children.) Pp. 246. (London: Seeley, Service Co., Ltd.) Price 4s. 6d. net.
11. **A Manual of Elementary Zoology**; by L. A. Borradaile. Third edition. Pp. xviii+616+xxi plates. (London: Henry Frowde and Hodder and Stoughton.) Price 18s.
12. **Essays on Wheat**, by Prof. A. H. R. Buller. Pp. xv+339. (New York: The Macmillan Co.; London: Macmillan & Co., Ltd.) Price 2.50 dollars.

THE following publications have been issued by the Imperial Department of Agriculture in India since our last issue:—

1. **A Note on the Treatment of Surra in Camels by Intravenous Injections of Tartar Emetic**, by H. E. Cross, M.R.C.V.S., D. V. H., A.Sc. (Bulletin No. 95.) Price, As. 2.
2. **Motor Tractors at Lincoln Trials, September, 1919.** Free.

PUBLICATIONS OF THE IMPERIAL DEPARTMENT OF AGRICULTURE IN INDIA

TO BE HAD FROM

THE OFFICE OF THE AGRICULTURAL ADVISER TO THE GOVERNMENT OF INDIA, PUSA, BIHAR,
and from the following Agents :—

- | | |
|--|---|
| (1) THACKER, SPINK & CO., CALCUTTA. | (7) THACKER & CO., LTD., BOMBAY. |
| (2) W. NEWMAN & CO., CALCUTTA. | (8) SUNDER PANDURANG, BOMBAY. |
| (3) RAI M. C. SARKAR BAHADUR & SONS, CALCUTTA. | (9) RAI SAHIB M. GULAB SINGH & SONS, LAHORE. |
| (4) HIGGINBOTHAMS, LTD., MADRAS. | (10) MANAGER, EDUCATIONAL BOOK DEPOT, NAGPUR. |
| (5) THOMPSON & CO., MADRAS. | |
| (6) D. B. TARAPOREVALA, SONS & CO., BOMBAY. | |

A complete list of the publications of the Imperial Department of Agriculture in India can be obtained on application from the Agricultural Adviser to the Government of India, Pusa, Bihar, or from any of the above-mentioned Agents.

These publications are :—

1. *The Agricultural Journal of India*. A Journal dealing with subjects connected with agricultural economics, field and garden crops, economic plants and fruits, soils, manures, methods of cultivation, irrigation, climatic conditions, insect pests, fungus diseases, co-operative credit, agricultural cattle, farm implements, and other agricultural matters in India. Illustrations, including coloured plates, form a prominent feature of the Journal. It is edited by the Agricultural Adviser to the Government of India, and is issued once every two months or six times a year. *Annual Subscription*, Rs. 6 or 9s. 6d., including postage. Single copy, R. 1-8 or 2s.
2. Scientific Reports of the Agricultural Research Institute, Pusa (including the Report of the Imperial Cotton Specialist).
3. Annual Report on the Progress of Agriculture in India.
4. Proceedings of the Board of Agriculture in India.
5. Proceedings of Sectional Meetings of the Board of Agriculture.
6. Memoirs of the Imperial Department of Agriculture in India :
 - (a) Botanical Series.
 - (b) Chemical Series.
 - (c) Entomological Series.
 - (d) Bacteriological Series.
 - (e) Veterinary Series.
7. Bulletins issued by the Agricultural Research Institute, Pusa.
8. Books.

The following are the publications of the last two years :—

- Scientific Reports of the Agricultural Research Institute and College, Pusa (including the Report of the Imperial Cotton Specialist), for the year 1917-18. Price, R. 1-4 or 2s.
- Scientific Reports of the Agricultural Research Institute, Pusa (including the Report of the Imperial Cotton Specialist), for the year 1918-19. Price, R. 1-4 or 2s.
- Report on the Progress of Agriculture in India for the year 1917-18. Price, R. 1-8 or 2s. 3d.
- Report on the Progress of Agriculture in India for the year 1918-19. Price, R. 1-8 or 2s. 3d.
- Proceedings of the Board of Agriculture in India, held at Pusa on the 1st December, 1919, and following days (with Appendices). Price, As. 12 or 1s. 3d.
- Proceedings of the Second Meeting of Mycological Workers in India, held at Pusa on the 20th February, 1919, and following days. Price, As. 11 or 1s.
- Proceedings of the First Meeting of Agricultural Chemists and Bacteriologists, held at Pusa on 24th February, 1919, and the following days. Price, R. 1 or 1s. 6d.

AGRICULTURAL PUBLICATIONS—(Conold.)

- Proceedings of the First Meeting of Veterinary Officers in India, held at Lahore on the 24th March, 1919, and following days (with Appendices). Price, As. 8 or 8d.
- Proceedings of the Third Entomological Meeting, held at Pusa in February, 1919. (*In the press.*)

MEMOIRS OF THE DEPARTMENT OF AGRICULTURE IN INDIA

BOTANICAL SERIES

- Vol. IX, No. IV. Studies in Indian Sugarcanes, No. 3. The Classification of Indian Canes with special reference to the Sarethia and Sunnabille Groups, by C. A. BARBER, sc.D. Price, R. 2-4 or 3s.
- Vol. IX, No. V. *Phytophthora Meadii* n. sp. on *Hevea brasiliensis*, by W. MORAÉ, M.A., B.Sc., F.L.S. Price, R. 1-4 or 2s.
- Vol. X, No. I. The Rice Worm (*Tylenchus angustus*) and its Control, by E. J. BUTLER, M.B., F.L.S. Price, R. 1-4 or 2s.
- Vol. X, No. II. Studies in Indian Sugarcanes, No. 4. Tillering or Underground Branching, by C. A. BARBER, C.I.E., sc.D., F.L.S. Price, R. 4-4 or 7s.
- Vol. X, No. III. Studies in Indian Sugarcanes, No. 5. On testing the suitability of sugarcane varieties for different localities, by a system of measurements. Periodicity in the growth of the sugarcane, by C. A. BARBER, C.I.E., sc.D., F.L.S. Price, R. 1-12 or 3s.
- Vol. X, No. IV. A *Pythium* Disease of Ginger, Tobacco and Papaya, by L. S. Subramaniam. Price, R. 1-8 or 2s. 6d.
- Vol. X, No. V. Studies in the Pollination of Indian Crops, 1, by A. HOWARD, GABRIELLE L. O. HOWARD, and ABDUR RAHMAN KHAN. Price, R. 1-4 or 2s. 6d.
- Vol. X, No. VI. "Kumpta" Cotton and its Improvement, by G. L. KOTTUR, B. Ag. (*In the press.*)
- Vol. XI, No. I. Some Aspects of the Indigo Industry in Bihar. Part I. The Wilt Disease of Indigo. Part II. The factors underlying the seed production and growth of Java Indigo, by ALBERT HOWARD, C.I.E., M.A., and GABRIELLE L. O. HOWARD, M.A., with the assistance of CHOWDHURY RAMDHAN SINGH and MAULVI ABDUR RAHMAN KHAN. (*In the press.*)
- Vol. XI, No. II. Studies in Diseases of the Jute Plant. (1) *Diplozia Corchori*, Syd., by F. J. F. SHAW, D.Sc., A.R.C.S., F.L.S. (*In the press.*)

CHEMICAL SERIES

- Vol. V, No. II. "Heart Damage" in Baled Jute, by R. S. FINLOW, B.Sc., F.I.C., F.O.S. Price, R. 1 or 1s. 6d.
- Vol. V, No. III. Experiments on the Improvement of the Date Palm Sugar Industry in Bengal, by HAROLD E. ANNETT, B.Sc., F.I.C.; GOSTA BEHARI PAL, M.Sc.; and INDU BHUSHAN CHATTERJEE, L.Ag. Price, R. 1 or 1s. 6d.
- Vol. V, No. IV. Cholam (*A. Sorghum*) as a Substitute for Barley in Malting Operations, by B. VISWANATH, T. LAKSHMANA ROW, B.A., and P. A. RAGHUNATHASWAMI AYYANGAR, Dip. Ag. Price, As. 12 or 1s.
- Vol. V, No. V. The Phosphate Requirements of some Lower Burma Paddy Soils, by F. J. WARTH, M.Sc., B.Sc., and Maung Po Shin. Price, R. 1-12 or 3s. 3d.
- Vol. V, No. VI. Absorption of Lime by Soils, by F. J. WARTH, M.Sc., B.Sc., and MAUNG PO SAW. Price, R. 1-2 or 2s.
- Vol. V, Nos. VII & VIII. The Gases of Swamp Rice Soils, V.—A Methane-oxidising Bacterium from Rice Soils, by P. A. Subrahmanya Ayyar, B.A.; and The Gases of Swamp Rice Soils, VI—Carbon Dioxide and Hydrogen in relation to Rice Soils, by W. H. Harrison, D.Sc. (*In the press.*)
- Vol. V, No. IX. The Retention of Soluble Phosphates in Calcareous and Non-calcareous Soils, by W. H. Harrison, D.Sc., and Surendra Lal Das, M.Sc. (*In the press.*)

ENTOMOLOGICAL SERIES

- Vol. V, No. V. The Rice Leaf-hoppers (*Nephotettia bipunctatus*, Fabr. and *Nephotettia apicalis*, Metach.), by C. S. MISRA, B.A. (*In the press.*)
- Vol. V, No. VI. *Lantana* Insects in India. Being the Report of an Inquiry into the Efficiency of Indigenous Insect Pests as a Check on the Spread of *Lantana* in India, by RAO SAHIB Y. RAMAACHANDRA RAO, M.A., F.R.S. Price, R. 2-4 or 4s. 6d.
- Vol. VI. Life-histories of Indian Insects: Microlepidoptera, by T. BALNBRIDGE FLETCHER, B.N., F.L.S., F.R.S., F.Z.S., Imperial Entomologist. (*In the press.*)

ENTOMOLOGICAL SERIES—(Concl'd.)

- Vol. VI, No. I. Pterophoridaæ.
 Vol. VI, No. II. Carposinidæ, Phalonidæ, Tortricidæ and Eucosmidæ.
 Vol. VI, No. III. Gelechiadæ.
 Vol. VI, No. IV. Cosmopterygidæ, Cœcophoridæ, Physoptilidæ, Xyloryctidæ, Stenomidæ and Orneodidæ.
 Vol. VI, No. V. Heliozelidæ, Heliodinidæ, Glyphipterygidæ, Blastobasidæ and Hyponomeutidæ.
 Vol. VI, No. VI. Gracillariadæ.
 Vol. VI, No. VII. Epermeniadæ, Plutellidæ and Lyonetiadæ.
 Vol. VI, No. VIII. Tineidæ and Nepticulidæ.
 Vol. VI, No. IX. Appendix.
 Vol. VII, Nos. 1 & 2. New Indian Gall Midges (Diptera), by E. P. FERT, State Entomologist of New York, U. S. A.; and Description of a Rhinocyphine larva from Shillong, by MAJOR F. C. FRASER, I.M.S. Price, As. 12 or 1s. 6d.

BACTERIOLOGICAL SERIES

- Vol. I, No. VIII. Pebrine in India, by C. M. HUTCHINSON, B.A. (*In the press.*)
 Vol. I, No. IX. Studies on the Root Nodule Organism of the Leguminous Plants, by N. V. JOSHI, M.Sc., B.A., L. Ag. (*In the press.*)

VETERINARY SERIES

- Vol. III, No. I. The Vitality of the Rinderpest Virus outside the Animal Body under Natural Conditions, by A. W. SHILTON, M.R.C.V.S. Price, As. 12 or 1s.
 Vol. III, No. II. The Virulence of Tubercle Bacilli isolated from Bovine Lesions in India, by A. L. SHEATHER, B.Sc., M.R.C.V.S. (*In the press.*)
 Vol. III, No. III. Bovine Lymphangitis, by A. L. SHEATHER, B.Sc., M.R.C.V.S. (*In the press.*)

BULLETINS ISSUED BY THE AGRICULTURAL RESEARCH INSTITUTE, PUSA

- No. 81. The Value of Phosphatic Manures in India and the Possibility of their Manufacture on a Larger Scale. Being evidence submitted to the Committee appointed to discuss this question (Subject IX) at the Meeting of the Board of Agriculture, Poona, 1917. Edited, with an Introduction, by W. A. DAVIS, B.Sc., A.C.G.I. Price, As. 4 or 5d.
 No. 82. The Improvement of the Indigenous Methods of *Gur* and Sugar making in the United Provinces, by WILLIAM HULME and R. P. SANGHI. Price, As. 8 or 9d.
 No. 83. Progress of the Sugarcane Industry in India during the Years 1916 and 1917. Being Notes submitted to the Meeting of the Board of Agriculture in India, Poona, 1917. Edited, with an Introduction, by C. A. BARBER, C.I.E., Sc.D., F.L.S. Price, As. 5 or 6d.
 No. 84. The Best Means of Rapidly Increasing the Outturns of Food Crops by Methods within the Power of the Agricultural Department. Being Notes submitted to the Meeting of the Board of Agriculture in India, Poona, 1917. Edited, with an Introduction, by J. MACKENNA, C.I.E., I.C.S. Price, As. 4 or 5d.
 No. 85. Soil Drainage, by R. G. ALLAN, M.A. Price, As. 4 or 5d.
 No. 86. A New Nematode causing Parasitic Gastritis in Calves, by A. L. SHEATHER, B.Sc., M.R.C.V.S. Price, As. 4 or 5d.
 No. 87. A Contribution to our Knowledge of South Indian Coccidæ, by T. V. RAMAKRISHNA AYYAR, B.A., F.E.S., F.Z.S. Price, As. 14 or 1s. 6d.
 No. 88. Cawnpore-American Cotton: An Account of Experiments in its Improvement by Pure Line Selection and of Field Trials, 1915-1917, by B. C. BURT, B.Sc., and NIZAMUDDIN HAIDER. Price, As. 10 or 1s.
 No. 89. Second Hundred Notes on Indian Insects. Price, R. 1-4 or 2s.
 No. 90. A Malarial Parasite in the Blood of a Buffalo, by A. L. SHEATHER, B.Sc., M.R.C.V.S. Price, As. 8 or 7d.
 No. 91. Notes on Practical Salt Land Reclamation, by G. S. HENDERSON, N.D.A., N.D.D. Price, As. 6.
 No. 92. *Syngamus laryngeus* in Cattle and Buffaloes in India, by A. LESLIE SHEATHER, B.Sc., M.R.C.V.S., and A. W. SHILTON, M.R.C.V.S. Price, As. 6.
 No. 93. The Orange: The Trial of Stocks at Peshawar, by W. ROBERTSON BROWN. (*In the press.*)

**BULLETINS ISSUED BY THE AGRICULTURAL RESEARCH
INSTITUTE, PUSA—(Concl'd.)**

- No. 94. A Preliminary Note on the Behaviour in North India of the first batch of Sugarcane Seedlings raised at the Sugarcane-breeding Station, Coimbatore, by T. S. VENKATRAMAN, B.A. Price, As. 8.
- No. 95. A Note on the Treatment of Surra in Camels by Intravenous Injections of Tartar Emetic, by H. E. CROSS, M.R.C.V.S., D.V.H., A.Sc. Price, As. 2.
- No. 96. The Course that Surra runs in Camels when Naturally contracted and when Artificially Inoculated, by H. E. CROSS, M.R.C.V.S., D.V.H., A.Sc. (*In the press.*)
- No. 97. The Course that Camel Surra runs in Ponies, Buffaloes and other Animals, by H. E. CROSS, M.R.C.V.S., D.V.H., A.Sc. (*In the press.*)
- No. 98. *Ustilago Cramerie*, Koern, on *Setaria italica*, by S. SUNDERARAMAN. (*In the press.*)

INDIGO PUBLICATIONS

- No. 1. A Study of the Indigo Soils of Bihar. The Urgent Necessity for Immediate Phosphate Manuring if Crops are to be Maintained, by W. A. DAVIS, B.Sc., A.C.G.I. Price, R. 1-4 or 2s.
- No. 2. Present Position and Future Prospects of the Natural Indigo Industry, by W. A. DAVIS, B.Sc., A.C.G.I. Price, As. 10 or 1s.
- No. 3. The Loss of Indigo caused by Bad Settling and the means of obviating this. The use of Dhak Gum—its Effect on Yield and Quality, by W. A. DAVIS, B.Sc., A.C.G.I. Price, As. 4 or 5d.
- No. 4. The Future Prospects of the Natural Indigo Industry: The Effect of Superphosphate Manuring on the Yield and Quality of the Indigo Plant, by W. A. DAVIS, B.Sc., A.C.G.I. Price, As. 4 or 5d.
- No. 5. An Improved Method of preparing Indican from Indigo-yielding Plants, by BHAILAL M. AMIN, B.A. Price, As. 2 or 3d.
- No. 6. The Effect of Manuring with Superphosphate and Sannai on the Yield of Crops on Indigo Planters' Estates in Bihar—especially of Rabi Crops in the Season 1918-1919, by W. A. DAVIS, B.Sc., A.C.G.I. Price, As. 6.
- No. 7. The Conditions affecting the Quality of the Java Indigo Plant (Leaf yield and richness of the leaf in indigotin), by W. A. DAVIS, B.Sc., A.C.G.I. (*In the press.*)

BOOKS

- "Indian Insect Pests," by H. MAXWELL-LEFROY, M.A., F.E.S., F.Z.S. Price, R. 1-8 or 2s (*Out of print.*)
- "Indian Insect Life," by H. MAXWELL-LEFROY, M.A., F.E.S., F.Z.S.; and F. M. HOWLETT, B.A. 786 pp. Price, Rs. 20 or 30s. (*Out of print.*)
- "Wheat in India," by ALBERT HOWARD, M.A., A.R.C.S., F.L.S.; and GABRIELLE L. C. HOWARD, M.A. 288 pp. Price, Rs. 5 or 7s. 6d.
- "A Description of the Imperial Bacteriological Laboratory, Muktesar: Its Work and Products," by Major J. D. E. HOLMES, M.A., D.Sc., M.R.C.V.S. Price, As. 8 or 9d.
- "Agriculture in India," by JAMES MACKENNA, M.A., I.C.S. Price, As. 4 or 5d.
- "Some Diseases of Cattle in India. A Handbook for Stock-owners." Price, As. 8 or 9d.
- "The Importance of Bacterial Action in Indigo Manufacture," by C. M. HUTCHINSON, B.A. Price, As. 2 or 3d.
- "Report of the Proceedings of the Second Entomological Meeting, held at Pusa on the 5th-12th February, 1917." Price, Rs. 3.

Report of the Indian Cotton Committee. Vol. I, Report; Vol. II, Maps and Plans. Price R. 1 per volume. (Superintendent: Government Printing, India, Calcutta.)

VOL. XV, PART V

September 1920

THE AGRICULTURAL JOURNAL OF INDIA

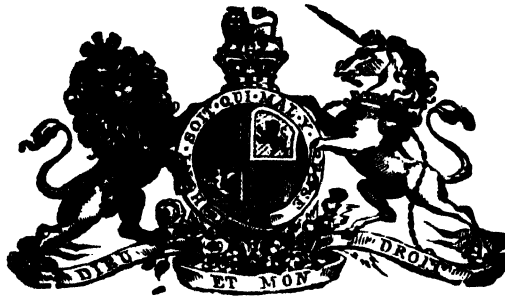

EDITED BY

The Agricultural Adviser to the Government of India

PUBLISHED FOR

THE IMPERIAL DEPARTMENT OF AGRICULTURE IN INDIA

BY

THACKER, SPINK & CO., CALCUTTA

W. THACKER & CO., 2, CREED LANE, LONDON

Price R. 1-8 or Two Shillings

Agents for the Sale of Government Publications

IN EUROPE

- Constable & Co., 10, Orange Street, Leicester Square, London, W.C.
Kegan Paul, Trench Trübner & Co., 68-74, Carter Lane, E.C., and 25, Museum Street, London, W.C.
Bernard Quaritch, 11, Grafton Street, New Bond Street, London, W.
P. S. King & Sons, 2 & 4, Great Smith Street, Westminster, London, S.W.
H. S. King & Co., 65, Cornhill, E.C., and 9, Pall Mall, London, W.
Grindlay & Co., 54, Parliament Street, London, S.W.
Luzac & Co., 46, Great Russell Street, London, W.C.
W. Thacker & Co., 2, Creed Lane, London, E.C.
T. Fisher Unwin, Limited, 1, Adelphi Terrace, London, W.C.
B. H. Blackwell, 50 & 51, Broad Street, Oxford.
Deighton, Bell & Co., Ltd., Cambridge.
Oliver & Boyd, Tweeddale Court, Edinburgh.
E. Ponsonby, Ltd., 116, Grafton Street, Dublin.
Ernest Leroux, 28, Rue Bonaparte, Paris.
Martinus Nijhoff, The Hague, Holland.

IN INDIA AND CEYLON

- Thacker, Spink & Co., Calcutta and Simla.
W. Newman & Co., Calcutta.
R. Cambray & Co., Calcutta.
S. K. Lahiri & Co., Calcutta.
B. Bannerjee & Co., Calcutta.
The Indian School Supply Depôt, 309, Bow Bazar Street, Calcutta, and 226, Nawabpur, Dacca.
Butterworth & Co. (India), Ltd., Calcutta.
Rai M. G. Sarkar Bahadur & Sons, 75-1-1, Harrison Road, Calcutta.
The Weldon Library, 18-5, Chowringhee Road, Calcutta.
Standard Literature Co., Ltd., Calcutta.
Lal Chand & Sons, Calcutta.
Higginbothams, Ltd., Madras.
V. Kaliyanarama Iyer & Co., Madras.
G. A. Natesan & Co., Madras.
S. Murthy & Co., Madras.
Thompson & Co., Madras.
Temple & Co., Madras.
P. R. Rama Iyer & Co., Madras.
E. M. Gopalakrishna Kone, Madura.
Thacker & Co., Ltd., Bombay.
A. J. Combridge & Co., Bombay.
D. B. Taraporevala, Sons & Co., Bombay.
Mrs. Radhabai Atmaram Sagoon, Bombay.
Sunder Pandurang, Bombay.
Gopal Narayan & Co., Bombay.
Ramchandra Govind & Son, Kalbadevi, Bombay.
A. H. Wheeler & Co., Allahabad, Calcutta, and Bombay.
N. B. Mathur, Superintendent, Nazir Kanun-i-Hind Press, Allahabad.
Rai Sahib M. Gulab Singh & Sons, Mufid-i-Am Press, Lahore.
A. Chand & Co., Lahore, Punjab.
Ram Krishna & Sons, Lahore.
Superintendent, American Baptist Mission Press, Rangoon.
Manager, the "Hitavada," Nagpur.
S. C. Talukdar, Proprietor, Students & Co. Cooch Behar.
A. M. & J. Ferguson, Colombo, Ceylon.
Manager, Educational Book Depôts, Nagpur and Jubbulpore.*
Manager of the Imperial Book Depôt, 63, Chandney Chauk Street, Delhi.*
Manager, "The Agra Medical Hall and Co-operative Association, Ltd." (Successors to A. John & Co., Agra.)*
Superintendent, Basel Mission Book and Tract Depository, Mangalore.*
P. Varadachary & Co., Madras.*
H. Liddell, Printer, etc., 7, South Road, Allahabad.*
D. C. Anand & Sons, Peshawar.*
Ram Dayal Agarwala, 184, Katra, Allahabad.*
Manager, Newal Kishore Press, Lucknow.*

* Agents for the sale of Legislative Department Publications only.

CONTENTS

(VOL. XV, PART V.)

ORIGINAL ARTICLES

PAGE

SOME COMMON INDIAN BIRDS. NO. 5. THE GOLDEN-BACKED WOODPECKER (<i>Brachy- pternus aurantius</i>)	<i>T. Bainbrigge Fletcher, R.N., F.L.S., F.E.S., F.Z.S. ; and C. M. Inglis, M.B.O.U., F.Z.S.</i> ..	181
THE EGYPTIAN COTTON PROBLEM : A REPORT TO THE EGYPTIAN GOVERNMENT. I ..	<i>H. Martin Leake, M.A., F.L.S.</i> ..	485
THE EXCRETION OF TOXINS FROM THE ROOTS OF PLANTS	<i>J. N. Mukerji, B.A., B.Sc.</i> ..	502
A PRELIMINARY NOTE ON THE IMPROVEMENT OF ORANGES	<i>K. P. Shrivastava</i> ..	508
THE TOP-WORKING OF INDIAN FRUIT TREES ..	<i>W. Burns, D.Sc. ; and P. G. Joshi</i> ..	516
IMPROVED FURNACES FOR <i>Gur</i> MANUFACTURE ..	<i>G. K. Kelkar, B.Ag.</i>	521
<i>Gur</i> -MAKING FROM THE JUICE OF THE DATE- PALM (<i>Phœnix sylvestris</i>) IN THE THANA DISTRICT OF THE BOMBAY PRESIDENCY	<i>V. G. Patwardhan, B.Ag., B.Sc.</i> ..	
THE INFLUENCE OF STOCK AND SCION AND THEIR RELATION TO ONE ANOTHER	<i>S. H. Prayag, M.Ag.</i>	533

SELECTED ARTICLES

THE GROWTH OF THE SUGARCANE, IV	343
WATER HYACINTH : A MENACE TO NAVIGATION	550
BRITISH CROP PRODUCTION	556
THE ORIGIN OF THE SUGARCANE	564

NOTES

PAGE

THE GINNING PERCENTAGE OF COTTON IN ITS RELATION TO THE SEASON	568
AGRICULTURAL EDUCATION IN MADRAS	570
SEED ELECTRIFICATION	570
LOW-GRADE SUGARCANE MOLASSES (BLACKSTRAP)	571
A NOTE ON SOME PRELIMINARY EXPERIMENTS FOR STUDYING CROP IRRIGATION	574
PERSONAL NOTES, APPOINTMENTS AND TRANSFERS, MEETINGS AND CONFERENCES, ETC.	578

REVIEWS

THE CULTIVATION OF RAGI IN MYSORE	583
AMMONIFICATION OF MANURE IN SOIL	584
NEW BOOKS ON AGRICULTURE AND ALLIED SUBJECTS	586

LIST OF ILLUSTRATIONS

The Golden-backed Woodpecker (<i>Brachypternus aurantius</i>)		Frontispiece
		Facing Page
Plate XXVI.	Properly lifted orange plant from nursery and pruned orange trees	510
„ XXVII.	Furrow and trench systems of irrigation	514
„ XXVIII.	Top-working of Indian fruit trees	516
„ XXIX.	ditto ditto	517
„ XXX.	ditto ditto	519
„ XXXI.	Influence of stock on scion in <i>Citrus</i> plants	535
„ XXXII.	Branching system of <i>Saccharum arundinaceum</i>	544
„ XXXIII.	Dissections of a "Java" clump of canes and of a "Red Mauritius" ratoon	548

*The following Original Articles will appear in our next issue
(November 1920).*

- SOME COMMON INDIAN BIRDS. NO. 6. THE
WHITE WAGTAIL (*Motacilla alba*) .. T. Bainbrigge Fletcher.
R.N., F.L.S., F.E.S.,
F.Z.S.; and C. M. Inglis,
M.B.O.U., F.Z.S.
- THE EGYPTIAN COTTON PROBLEM: A REPORT
TO THE EGYPTIAN GOVERNMENT, II .. H. Martin Leake, M.A.,
F.L.S.
- SOME OBSERVATIONS ON THE ROOTS OF FRUIT
TREES W. Burns, D.Sc.; and L. B.
Kulkarni, L.Ag.
- THE AMERICAN BLIGHT OR "THE WOOLLY
APHIS," *Eriosoma (Schizoneura) lanigera*,
Hausmann C. S. Misra, B.A.
- A PRELIMINARY NOTE ON THE EFFECT OF
WATERINGS ON THE AMOUNT OF ACIDS
SECRETED BY THE GRAM PLANT (*Cicer
arietinum*) D. L. Sahasrabudde
- MALFORMATION OF THE COTTON PLANT LEADING
TO STERILITY G. L. Kottur, B.Ag.; and
M. L. Patel, B.Ag.
- THE CHEMICAL AND BIOLOGICAL ASPECT OF
Bhata SOIL OF CHANDKHURI EXPERIMENTAL
FARM, CENTRAL PROVINCES A. R. Padmanabha Aiyer,
B.A.; and D. V. Bal,
L.Ag.



THE GOLDEN-BACKED WOODPECKER (*BRACHYPTERNUS AURANTIUS*).

Original Articles

SOME COMMON INDIAN BIRDS.

No. 5. THE GOLDEN-BACKED WOODPECKER (*BRACHYPTERNUS AURANTIUS*).

BY

T. BAINBRIGGE FLETCHER, R.N., F.L.S., F.E.S., F.Z.S.,

Imperial Entomologist ;

AND

C. M. INGLIS, F.Z.S., M.B.O.U.

MANY of the roads on the Pusa Estate being well bordered by trees, it is a common experience to hear the quickly-repeated tapping sound of a woodpecker as it digs away with its beak at a branch in which it has perceived the presence of some wood-boring insect. If the noise is traced to its source, it will usually be found to originate from a medium-sized bird coloured in black and golden-yellow and with a bright crimson crest, which may be seen clinging to the bark with its powerful claws, supported by its short stiff tail, and hammering away with its short, stout, chisel-like bill. This bird is the Golden-backed Woodpecker (*Brachypternus aurantius*), which is common throughout India and Ceylon, from Sind and the Punjab to Eastern Bengal, ascending the hills to about three or four thousand feet, but not apparently known from Upper Assam or Burma or in the Duars. It is generally seen singly or in pairs and often one may be seen following the other from tree to tree. In Ceylon it is

accompanied by the Red-backed Woodpecker (*B. erythronotus*), which, as its name implies, is distinguished by having its back crimson, whereas in *B. aurantius* the back is golden-yellow or orange. Where both species occur together, it is probable that they hybridize occasionally. As regards other species of woodpeckers with which this one may be confused, the Common Golden-backed Three-toed Woodpecker (*Tiga javanensis*) is extremely like this bird and only markedly differs in wanting the hallux (inner hind toe). Tickell's Golden-backed Woodpecker (*Chrysocolaptes gutticristatus*) has also a very similar coloration but on account of its very much larger size is less likely to be mistaken for *B. aurantius* than is *Tiga javanensis*.

The Golden-backed Woodpecker is an extremely handsome bird, which Dewar briefly describes as having a bright crimson crest, top of head black, sides of head white with a number of black lines and streaks, upper back golden-yellow, lower back and tail black, wings black and golden-yellow with some white spots. The female differs from the male in having the top of the head black with small white triangular spots; it is shown peeping around the tree in our Plate. Unfortunately, like the Indian Roller, its voice is not in harmony with its plumage, its call, which is often uttered on the wing, being a loud harsh scream. Like the Roller also, it is rather a noisy bird.

Like all woodpeckers, it is an extremely skilful climber, seldom or never perching crosswise on a branch but clinging, always with the tail downward, to the stems and branches of trees, which it usually ascends and descends diagonally. The flight is undulating. It is seldom seen on the ground but occasionally descends to feed on ants which seem to form an appreciable proportion of its normal food, this consisting almost entirely of insects, largely ants varied with numerous small beetles, caterpillars and bugs, to which buds and fruits may occasionally be added. The late C. W. Mason examined the stomachs of sixteen birds throughout the year at Pusa and found 3,921 insects of which the great majority were ants, and it is notable that only one of these sixteen birds was found to contain longicorn beetle larvæ, although observation renders it certain that this bird does feed to some extent on wood-boring insects, which its

long, worm-like, extensile tongue, armed with a many-barbed horny tip, is so admirably fitted to extract from their burrows after these have been laid open by the vigorous blows of the strong chisel-like beak. In Eastern Bengal it is stated to feed on the larvæ and pupæ of *Hoplocerambyx spinicornis*, a longicorn borer pest of *sal* (*Shorea robusta*), and in Madras it is stated to be very partial to toddy-palms, which may be due to the fact that these trees are infested by *Oryctes rhinoceros* and *Rhynchophorus ferrugineus*. At Pusa many of the dead *sissu* branches, at which one sees this woodpecker tapping away, are infested with a tree-living termite (*Coptotermes heimi*) and, although Mr. Mason's stomach-records do not support this, it is probable that this termite may provide a certain proportion of its food. As is the case with so many of our common Indian birds, it is wonderful how little we really know about its daily life. However, from the little we do know, we are justified in counting the Golden-backed Woodpecker, with all its kindred, amongst the farmer's friends.

Like other woodpeckers it nests in a hole in a tree, often in a mango tree in Northern India; in Bihar nests have been found in mango, litchi, *sissu* and *siris* trees. In the Southern part of its range it breeds from February to June but in the Northern part it breeds from March to July, courtship being of a rather rough and ready fashion, punctuated by harsh screams. The glossy white (delicate salmon-pink when fresh and unblown) eggs, usually three in number, measuring about 28 millimetres long by 20 broad, are laid in a hole excavated in a tree by the parents or more frequently in a natural cavity to which merely an entrance has been made by the birds. Dewar states that "woodpeckers seem to excavate a new nest every year," but we are not aware how far this is the case. Woodpeckers, however, are very apt to desert any nest-hole that has been interfered with at all. We have many times found them to do this even when no chipping was done to enlarge the hole, the only interference being by means of a thin twig. Sometimes also they only partly excavate a hole and then leave it for another site. The nest-hole is about two and a half to three and a half inches in diameter and usually runs in horizontally for about three to six inches and then

turns downwards. When the downward shaft is bored by the bird it is rarely more than eight or nine inches deep with a chamber of some five or six inches in diameter, but when the bird cuts into a natural cavity in the tree the egg may be found two or three feet below the entrance. No regular nest is formed, the eggs being laid on a few chips of wood. The young, when first hatched, are naked but assume the sexual coloration with the first feathers. If caught young, they may be trained to a diet of "sattoo" with some soft fruit and occasionally some insects.

In Bengal, Burma, Madras, Bombay and Assam this bird is protected by law throughout the whole year

[*Note.* For the purpose of these papers I have used for this bird the specific name *aurantius* given in the *Fauna of India* volume. The correct name is, however, apparently *benghalensis* under which name it was first described by Linnaeus in the tenth edition of the *Systema Naturae* (1758; pp. 113-114), in which there is no mention of any species under the name *aurantius*. The *Fauna* volume quotes the twelfth edition (1766) as the authority for *aurantius* and *bengalensis*; I have not had access to this edition, but in the thirteenth edition, edited by Gmelin in 1788, this bird is referred to (Vol. I, pp. 433-434) under the name *bengalensis*, whilst *Picus aaurantius* is recorded from the Cape of Good Hope (*l.c.*, p. 430). Not being an ornithologist and not having access to the necessary literature, I do not propose to do more than point out that *benghalensis*, Linn. (1758) is apparently the correct name for the Golden-backed Woodpecker.—T. B. F.]

THE EGYPTIAN COTTON PROBLEM.

A REPORT TO THE EGYPTIAN GOVERNMENT.

BY

H. MARTIN LEAKE, M A., F.L.S.,

Director of Agriculture, United Provinces.

IN November 1918, I received an invitation to visit Egypt to report on the steps to be taken by the Government of that country for the maintenance and improvement of the quality of Egyptian cotton and the increase of its yield. I visited the country on my way home in the spring of 1919 for the purpose of making preliminary enquiries and, on my return journey, spent some three months during the cotton season in the cotton-growing districts.

The results of my enquiry are embodied in the report here published. In many respects, economic, practical and scientific, the problems encountered in the growing of cotton in Egypt are fundamentally different from the problems presented in India. Nevertheless there are points of similarity and it is possible that the report may be of some small value to those interested in the Indian problem; I am indebted to the Egyptian Government for permission to publish it in this Journal.

I cannot let pass the opportunity which here presents itself of expressing my great indebtedness to all those persons with whom I came into contact in the course of my visit and enquiry, especially to Mr. J. Langley, Under Secretary of State for Agriculture, and to Mr. E. Shearer, who is known to many of the members of the Agricultural Service of this country as a former member, for their unfailing courtesy and ever ready assistance.

INTRODUCTION.

In letter No. 383-4-1-3, dated the 19th May, 1919, of the Ministry of Agriculture, I was asked to present a report embodying my "recommendations with a view to the maintenance and improvement of the quality of Egyptian cotton and the increase of its yield." The existing qualities are definite and possess a material extant physical basis. The question of their maintenance, thus, offers a definite concrete problem. The same is the case with the question of yield; and the improvement of the yield consists in the very definite and material fact of an addition to the return obtained from the acre or *feddan*.* No such definiteness attaches to the third problem laid before me, that of the improvement of quality. Quality is a relative term and the nature of quality, good or bad, depends on the use to which the material in question is put. Those uses may vary from time to time and it is necessary, therefore, to study these uses and to form an idea of the probable tendencies in what we may term the economic aspect before it is possible to decide what will constitute an improvement.

There are, in fact, two directions from which a problem such as is presented by cotton production may be approached. We may ignore, for the time being, the economic, and concentrate on the agricultural aspect. In so doing, we should concentrate on the biological and physical problems involved, on the biological side, endeavour to ascertain that plant which will give the maximum return under the uncontrollable conditions of the environment, and on the physical side, attempt so to modify the controllable conditions of that environment, that the plant which we have chosen may develop to the full. Or we may commence with the study of the economic aspect, endeavour to ascertain the uses to which the raw product is put and the characteristics which give to that raw product its commercial value; to form an idea of what characteristics are most desirable in as far as their possession is likely to increase the value of the raw material which possesses them and, having arrived, as far as may be, at a definite conclusion on

* 1 *Feddan* = 5,024 sq. yard = 1.04 acre.

this matter, we may attempt to arrive at that standard by means of biological investigation.

The former method assumes an adaptability in the market for the raw material which must be practically unlimited. This assumption may be true, or almost true, of certain agricultural products and in such cases the method may be safely adopted. It is in no sense, however, true of the cotton industry which is built up of a number of very specialized sections the raw material of one of which is unsuited, or even totally useless, for the purpose of another. This method is here, therefore, inapplicable and we are forced back on a study of the economic side of the question if we are to discover the fundamental conditions on which it will be possible to build a sound superstructure of biological investigation. My own personal experience has hitherto been restricted to the so-called short staple cottons of which the underlying economic conditions are fundamentally different from those of the Egyptian cotton, and I have, therefore, devoted some time and trouble during my stay in England in visiting Lancashire and investigating the economic aspect of Egyptian cotton. Such an investigation is essential to a correct formulation of those recommendations which are the more immediate object of my mission. I propose to commence the report by formulating the results of that investigation. Such procedure will simplify the expression of subsequent recommendations inasmuch as it will indicate the objective to which they are directed.

I.

The most prominent feature of the cotton industry, even in that strictly limited section which makes use of Egyptian cotton, is its diversity. Even among the spinners of Egyptian cotton are to be found users who have specialized on certain classes and who prefer those classes to any others. In many cases they may, and do, use other classes but such use is definitely a substitution use, dependent on such questions as limitation of supply or relative price, and is not willingly adopted. There is thus a definite, and natural, conservatism in the trade which opposes free interchange between classes even when such interchange is practicable.

The problem of Egyptian cotton is, therefore, not a simple one ; it is, on the contrary, a complex of problems. The unit is a single class which, under normal conditions, meets a particular demand. The value of that class is, to a certain extent, determined by the relation between supply and demand within the class itself and is, in part only, subject to the influence of the relation between total supply and total demand. It may actually occur that the spinner will pay less for an intrinsically superior cotton, in the sense that it will spin finer yarn, than for an inferior one.

We have here, I think, the first consideration that must be clearly borne in mind when approaching the problem from the producers' standpoint. Production is, and must continue to be, diverse. Not only so, but the various classes require to be produced in quantities approximating to the relative demand. Only so will the full intrinsic value for any particular class be realized. The argument applies equally to the lower, as to the higher, qualities ; over-production within the class leads to a low, while under-production leads to a high, price. The step from over-, to under-, production is, fortunately, sufficiently large owing to the flexibility of the market and this flexibility we must now consider a little more in detail.

The substitution of superior quality cotton to do the work of inferior can, naturally, be more readily adopted than the reverse process. The market, therefore, shows greatest flexibility in this direction. But such substitution will only take place, in the absence of any large shortage in total supply, when the price of the superior quality renders the proposition a paying one financially. Such conditions only hold good when the price of superior quality is relatively low or, in other words, when the superior quality is fetching less than its intrinsic value. Such a condition implies a definite loss to the producer. In a country like Egypt, which possesses a monopoly in the production of certain classes of cotton, this probably implies a considerable total loss since the reduction in price affects the entire outturn of the superior quality and not merely that portion which is used as a substitute. The rapidity with which Sakel has replaced other forms in cultivation in Lower Egypt affords an instance of this phenomenon. There is no doubt in my mind that

the production of Sakel is far in excess of the demand for the manufacture of those types of thread for which it is peculiarly adapted. Its use has, therefore, been extended to other lines for which it is not so pre-eminently suited and such extension has been effected at the expense of the producer in as far as Sakel is worth less per unit than it would be were only sufficient available to meet the needs of that market which requires the qualities peculiar to Sakel. The present demand is, in fact, a forced one due to the fact that, even at the depreciated price, the money return for the unit area of production is greater than that given by any other form.

That, however, is an illustration of one form of market flexibility merely. There is another, and more subtle, one the effects of which are harder to diagnose and still more difficult to foresee. I may illustrate this again by reference to Sakel. It was pointed out to me that the large increase in the consumption of Sakel coincided with the enormous development in the production of voiles, for the manufacture of which it is pre-eminently suited; it would appear, therefore, that, but for this coincident development, of a demand and of a means of meeting that demand, the price of Sakel would be lower than it is. We must, however, be careful to distinguish between cause and effect here. There appears to be little doubt that the sudden supply of a class of cotton particularly adapted to the manufacture of voiles is, in itself, in large measure, responsible for the demand which has arisen for that class of cloth. The demand for that material is largely artificial, depending as it does on fashions, and is capable of stimulation or the reverse, and it would appear that the power of directing the demand in such matters lies largely in the hands of the cotton trade. This form of flexibility is all to the good, for it means that the trade is in a position, to a certain extent, to test the qualities of any new form of cotton, to ascertain the classes of goods for which it is particularly suited and to stimulate the demand for that class of goods. We must, however, beware of pressing the possibilities in this direction too far. Cotton is not merely the basis of goods which have an artificial value due to fashions. In many cases the use to which the cloth is to be put will dictate, within very close limits, the qualities

that the cotton must possess. Notably we may instance the cloth which is used for aeroplanes and for motor tyres. Here no such flexibility is possible, for the demand is, in no sense, artificial. This case is particularly pertinent in the case of Egyptian cotton, for it is Egyptian cotton which has been found to satisfy this demand more nearly than any other.

This brings us to our second conclusion; the production of new cottons is desirable and the trade is sufficiently flexible to absorb and develop markets for them. But caution must be exercised in their introduction. An initial high price obtained for a small initial bulk may be due to special adaptability for the production of a particular class of goods the demand for which is small. If that high price stimulates largely increased production the price will fall even to make cultivation unprofitable. Especially is it necessary to distinguish between cottons which possess an intrinsic, and those which possess an artificial, value. The former require special care in maintenance.

So far we have confined ourselves to the broad issues as indicated by the characteristics of the trade in general. When we come to a more detailed consideration of the process of manufacture we find a new series of phenomena have to be considered. We need not here go into all the characteristics which go to make up a good spinning cotton. We have seen that diversity is essential to the trade; that it is desirable to produce different classes of cottons. The difference between these classes will, however, include most of those characteristics, such as length, strength, fineness, etc., which affect the behaviour of the cotton in the mill and the particular features of any class will be due to the exact form such characteristics take in that class. But beyond this, the spinner requires something more, something which is not a physical character of the cotton itself in the sense in which length, or strength, or fineness, or twist can be considered such. He requires what is usually known as uniformity; that is, a low range of variability in each one of those characters which go to make up the spinning value of a cotton.

Herein is to be found the third consideration to which we are led by our inquiry from the manufacturers' point of view. While

diversity of class is required, uniformity within the class is of equal importance.

The value of cotton is dependent, however, on other characteristics than those which affect its behaviour in the mill, and the more important of these is colour. The importance of colour lies in the fact that Egyptian cotton, till recently, possessed a characteristic brown colour by which it was distinguishable at a glance from other cottons. The point was recognized by the trade and the colour imparted to the cloth was accepted as a ready means of determining the fulfilment of contracts the specification for which included the use of Egyptian cotton. Such a ready method is valuable and there exists a natural conservatism in favour of the retention of that colour character. Colour has, however, no further significance. A premium will, for a time no doubt, be paid for colour owing to the lag which finds its basis in such conservatism. But here, again, the market is flexible and is capable of adaptation to the supply.

I have so far dealt with the trade aspect of Egyptian cotton in its present day form. It is, as must be the case with any highly organized manufacture involving highly specialized mechanical adaptations, very conservative. When, however, we are concerned with problems the solution of which may take years to accomplish, it is desirable to attempt, however imperfectly, to forecast the probable future demand. Such an attempt I have been at some pains to make during my visit to Manchester. The problem is complex and it is impossible to dogmatise. Nevertheless there appears to be a distinct opinion as to the general trend of this demand. This I will attempt to outline.

The complexity arises from two considerations. In the first place the trade is, as we have seen, so highly specialized that prices are affected by the relation of supply to demand within the class, and it is not possible to deal with the Egyptian crop as an entity. We must go lower than this to find the unit. Secondly, the monopoly which Egypt has hitherto possessed as the sole producer of special classes of cotton is gradually passing. Recently cottons which possess the characteristics of Egyptian have been produced in the

dry zones of America. Mesopotamia, again, and possibly Sind offer fields which may develop into rivals of Egypt. The monopolist position is, thus, already threatened and there is little doubt that it will at no distant date cease to exist. Such widening of the source of supply must inevitably affect the balance which now exists between the various classes of Egyptian cotton.

I may also refer to yet another aspect of the cotton trade which is likely to have a bearing on the future demand. Egyptian cotton ranks second among the world's cottons and is only surpassed by the so-called Sea Island, the main source of which is certain of the Southern States of America and the West Indies. The Sea Island crop is what is known as a highly speculative one; it has a narrow basis in that its cultivation is restricted to a relatively small tract and, from economic, as well as natural, causes, the supply is a precarious one. Not only is it more troublesome to cultivate, so that the extra price barely compensates for the extra labour and expense involved in the cultivation, but that cultivation is restricted to the more humid and tropical tracts in which the risk of sudden loss through pests and diseases is greatly enhanced. The margin of profit is, thus, insufficient to compensate for the extra risks involved, and the tendency is for the cultivation to diminish.

These facts all have their bearing on the Egyptian problem and, while they indicate an increasing competition from outside sources in the markets for the present standards of Egyptian cotton, they also indicate a probable reduction in the supply of Sea Island. The conclusion, it is true, is highly speculative but the tendency is there and is sufficiently clear to justify the attempt to develop a cotton which will be capable of taking the place of Sea Island in the future.

From the point of view of demand for goods manufactured from the higher grades of cotton I have found the opinion widely held that this demand is large though, at the present time, mainly potential. It is a demand capable of absorbing any amount of the best staple cotton Egypt is likely to be in a position to offer, and of absorbing it at its full relative value. In other words, the trade is sufficiently flexible to develop a demand equal to any

supply that can be offered. That this opinion is correct cannot, I think, be doubted, but it requires to be qualified in certain directions if the interests of the grower and dealer in raw cotton are to be adequately guarded.

The opinion has been expressed in the course of discussions on this subject that the facts do not support this view of the potential demand. It has been instanced that a short crop of Mit Affi in one year has led to the realization of a high relative price for that season's produce and that that price has reacted in the following year in a largely increased crop which, in its turn, has resulted in a heavily depreciated price. That experience is, no doubt, true; but it hardly justifies the conclusion which some would attempt to draw from it. It has already been pointed out that, owing to specialization in machinery and also to the necessity for experience in working a particular cotton if the best results are to be obtained from it, spinners are, as a rule, conservative. They will pay a premium for a class to which they are accustomed rather than change to another class, if the shortage which is responsible for that premium is of a temporary nature. The spinner, at least, knows what he can do with that cotton and his loss is, at most, limited to the amount of the premium he has to pay. The loss with a new cotton is less definite depending, as it does, on the speed with which he attains familiarity with its peculiarities in working. There is, thus, a definite time factor in such arguments the effect and importance of which must not be overlooked.

Before willingly making any change in his raw material, and this is merely another way of saying before he will overcome his natural conservatism, the spinner requires to be assured that the produce to which he turns will be available in sufficient and regular supply. Without such assurance, he will only accept the alternative under compulsion. For like reasons new plant, such as is required to meet the expanding needs of the industry, whether as extensions to existing factories or as new ones, will be adapted to handle the most assured supply capable of producing that class of goods for which the factory is designed. There is, consequently, a lag in the process of adjustment, an interval between the placing

of any new class of cotton on the market and the realization of its full intrinsic value, partly, no doubt, due to the fact that it takes time for the particular merits to be appreciated but, also, very largely due to ignorance of the potential supply. It is true that cases are on record of an immediate and rapid extension of the supply of a new class of cotton; this is true of Sakel, but such extension here takes place in spite of that lag which is none the less operative though its operation is masked. There is little doubt in my mind that it is possible that, nay more, that many instances have occurred in which a potentially valuable crop has been lost through too rapid development. The supply has been increased more rapidly than the demand, time has not been afforded to permit a general recognition of the special characteristics to develop and the full price has never been realized before the crop is condemned and passes out of cultivation. Neglect of the time factor is here responsible for the loss of a valuable improvement.

II.

I may now attempt to extract from the above brief review of the economic conditions, which are of influence in determining the value of the raw material of the cotton trade, the fundamental considerations for the development of a sound policy on the part of the producer. And here I may note that it does not necessarily follow that the interests of the individual producer will coincide with those of the producing community. We are, in reality, in the latter case, concerned with the solution of an algebraic problem, namely, to find the values for m , n , p , etc., which will give the maximum value to the following expression :

$$amx + bny + cpz + \dots \text{where}$$

a , b , c , are price units, x , y , z , yield units, and m , n , p , the number of the units produced of each of different classes A, B, C, In the case of Egypt where the limits of area of cotton cultivation are for the moment practically reached, we have the further consideration that

$$m + n + p + \dots = k \text{ a constant.}$$

The problem, so expressed, is clearly incapable of accurate solution owing to the large number of variables ; but the attempt is necessary if the maximum value is to be realized for the crop. The need of a solution, if only an approximate one, is especially necessary in a country like Egypt in which practically the entire wealth of the country is due to the one crop with which we are concerned.

If, further, the interests of the individual producer are to be protected, yet another algebraic problem must be solved. It will here be necessary that

$$ax = by = cz = \dots\dots\dots$$

Unless this condition is fulfilled, supposing, that is, that

$$ax > by > cz \dots\dots\dots$$

the producer of B and, still more, the producer of C, will be placed at a disadvantage as compared with the producer of A. Under such conditions, unless local conditions exercise a selective influence, the cultivation of B, and, to a still greater extent, of C, will diminish while the cultivation of A will extend. The only alternative is the elimination of the economic factor and for Government to control the proportionate cultivation of the different classes— a procedure hardly conceivable when such control must react to the detriment of a proportion of the individual producers.

We have here indicated the first problem to be solved with relation to cotton growing. Diversity is an essential requirement and such diversity will only be maintained if

$$ax = by = cz = \dots\dots\dots$$

The absolute solution of this problem, the equalization of the money returned by unit areas under the various types of cotton, is not possible, for the relative values of a , b , c , $\dots\dots\dots$ vary from year to year. An approximate solution only can be attained and may be sought in two directions. The various types which yield the different classes differ not only in regard to those lint characters which give these cottons their distinctive features, but they differ in other characters also. These characters we may term physiological, thereby implying a difference in reaction to environment. Egypt, in spite of its comparative uniformity in this respect, is really

uniform neither in climate nor in soil, and these differences are, in all probability, sufficient to meet the diverse physiological needs of the various types. It is more than probable that it will be found, in fact it is found, that the type which is best suited to one set of conditions will not be the one best suited to a second; and it will, thus, be possible to demarcate type tracts in each of which the cultivation of that type which responds best to the local environment can be encouraged. I do not overlook the work that has already been done in this direction; the point is appreciated, notably in the case of Ashmouni in Upper Egypt, but I am inclined to think that a large scope still remains for work in this direction on a systematic and predetermined plan.

Such investigation is definitely agricultural and it may, even so, be found that though the yield of B may be increased relatively, and even exceed that of A in certain areas, yet that increase still leaves the product ax greater than by —still leaves, that is, A the more profitable crop. To meet such a case the possibilities of the second method of equalizing the money value must be investigated.

It has been repeatedly pointed out that the commercial cottons of Egypt are impure; that is that they consist of a mixture of a larger or smaller number of types, together with a considerable admixture of crosses between these types. It is to this admixture that the deterioration of quality, so noticeable in most Egyptian cottons, and even that striking phenomenon of the definite limit to the life of any particular variety, is attributable. In such a mixture the total yield is clearly an average one, certain of the component types yielding more, and others less, than the average. Also certain of the types will be better, and others less, adapted in their physiological reaction to the local environment. The replacement of the mixture by those component types, or that component type best adapted to the environment, can have only one result, the raising of the unit yield from that of the mixture to that of the best of the component types. This method is what is commonly termed selection and we may conveniently consider here the third point raised in discussing the economic aspect, the need for uniformity, as well as the question of uniformity just referred to.

I have had occasion to observe that lint diversity, such as exists between the different classes of cotton, is, in practice, associated with a different physiological response to environmental conditions. The converse is equally true; mixtures such as compose and yield the main classes of cotton contain types which not only exhibit these physiological differences but also lint differences. Selection within the limits of the present accepted classes, thus, is not limited in scope to the isolation of what we may term physiological types. It may, and should, be also directed to the isolation, in a condition of purity, of those types yielding lint most nearly approximated to the class standard.

Deterioration has been repeatedly referred to as if it were a condition inherent in the plant. The particular variety is, in this view, supposed to possess a more or less definite span of life after which degeneration sets in and the lint product gradually deteriorates in quality. The word is unscientific and, as commonly and loosely applied, probably covers a number of phenomena. But, in as far as it implies a degeneration in the plant, it is unsound and finds no basis in fact. The cotton plant is notably freely cross-fertilized and the presence of a single impure plant in a field is capable of producing, in the course of a few seasons only, a degree of impurity which will surprise, and hardly be credited by, those who are unfamiliar with the phenomenon. Given initial purity and adequate protection from chance cross-fertilization this explanation of degeneration will be found to be fallacious. In selection and propagation under conditions which adequately meet the ever-present tendency to pass from purity to impurity, will be found the means of maintaining the uniformity desired by the spinner.

There remains the third desideratum expressed in the second conclusion at which we arrived above—that for the development of new classes of cotton; in other words, the introduction of an additional term into our algebraic formula. The history of the Egyptian cotton plant is a comparatively recent one and is too well known to require repetition in the pages of this report. The point I desire to emphasize here is the presence of the Sea Island plant at some stage of the parentage. We are at present too ignorant of the

'unit factors' on which the various lint characters depend, to state with certainty that those factors which are responsible for the special spinning qualities of the Sea Island cotton are bred out in their entirety. It is still possible that these exist here and there; it is even possible that they commonly exist in the present types of Egyptian cotton but are suppressed, masked or inhibited. Under the conditions of the Egyptian cotton field with the mixture of types now prevalent, and with unlimited possibilities for cross-fertilization between these, it would not be a matter for surprise if, now and again, such combinations should occur which will permit the re-expression of those characters. The sporadic occurrence of such 'throw-backs' is not unknown, and there is reason to believe that their occurrence is still taking place at the present time—the history of the origin of Sakel with its superior length is evidence in this direction. Here again selection is the means of preserving and establishing any such variations as may occur, but it is a selection which differs somewhat in form from that previously referred to. The latter can be undertaken within the limits of an experiment station, for what it is desired to select is known to exist, but in the former the entire area under cotton becomes the laboratory through which the search must be conducted.

The above method for developing new classes of cotton may be termed undirected, for we are dependent on accident for their appearance and merely, so to speak, gather the rose-bud offered to us while we may. The development may, however, be directed. For successful development of the directed method we must form a clear mental impression of what it is desired to produce; select, as parents, those plants which, in one or more of the characters concerned, approach most nearly to that ideal and attempt to combine these in a single individual. It is the method commonly referred to as hybridization. Success will only be obtained if a number of conditions are fulfilled. Purity of stock is essential and, therefore, preliminary selection to obtain that purity is necessary; also clear recognition of the factors on which are based those characters which we desire. The path is strewn with difficulties not the least of which is the exact determination of

the ideal, but these difficulties are not insuperable with sustained effort.

We have here considered the methods to be adopted for the introduction of a new term, or new terms, into the algebraic expression given above, and it may be argued that, if the new term conforms to the conditions of equality we have outlined, the advantage to the country from their introduction will be nil; while, if it does not, the already existing types must disappear. The argument is sound, but we must not forget the economic conditions affecting the question. Were these constant, it would be very doubtful whether it would be desirable to attempt the production of types yielding a lint superior to those already in existence. But economic conditions are not constant, notably, as we have already indicated, Egypt is losing her position as a monopolist, and such loss must inevitably lead, in the long run, to a reduction of the profit obtained from the standard classes of cotton produced by her at the present time. She will then be forced to 'go one better' than her competitors in producing finer qualities than she has hitherto done or to accept reduced revenues. It is a very real danger that exists and the presence of this danger makes it necessary to attempt the evolution of new classes. We may express the point in another way; while we do not look upon the multiplication of classes as a means of largely increasing the value of the crop, for qualities superior to the best Egyptian cotton have, at the present time, but a limited market and any premium obtained in the early years of low production would soon disappear when that production is largely increased, we do consider that their development is a necessary and vital insurance for the future.

The expression of the problem in the algebraic form given above brings into prominence certain other aspects which we must now consider. We desire that the sum

$$amx + bny + cpz + \dots\dots\dots$$

shall be a maximum while maintaining equality between the values ax , by , cz , $\dots\dots$. The latter desideratum requires further consideration in the light of what we have just said. This equality would be necessary to maintain diversity if the country were uniform;

but it is not. The difference which exists between the various types of cotton plant in their physiological response to environment, render it more than probable that, while *ax* may exceed *by* in one tract, the reverse will be the case in another. Such considerations will lead to the development of type tracts and the equality indicated will only develop a practical aspect in those border tracts where the type of cotton to be grown will be determined by the extent of the demand for the alternative classes of cotton these types produce and by the area already under those types. We must, therefore, qualify our earlier statement as to the need for equality in the value of the produce from a unit area. This has no general, but rather a local, significance.

Reverting to the main problem, we have studied certain methods which are directed to the end. They aim at the production of increased yield by purification of the crop and by demarcation of type areas; at the production of increased price through development of uniformity in the produce. We depend here on certain features of the environment which are selective, that is, features to which the different types react differently. There is, however, another series of environmental phenomena which are not to the same extent selective; of such a nature are the more important pests of the cotton plant, especially the boll-worm. Again much importance has rightly been attached to the height of the water table due directly and indirectly, through the canals, to the rise of the Nile. Lastly there is that series of phenomena which we may include under the general designation of cultural—the effect on yield of different spacings, different methods of culture, and such like. With these questions, beyond recognizing their importance and emphasizing the necessity for making adequate provision for their study in any serious attempt to face the cotton problem as a whole, we have no concern. It must not be forgotten, however, that such problems can be approached from both sides. On the one side is the plant, in the first case reacting to an insect and in the second to physical condition of the environment; on the other is the insect and, within limits, a controllable physical state. Not only do the insect and the physical condition require to be studied but also the plants'

reaction to these stimuli. In the first case, concurrently with entomological investigation, which has, among other facts, indicated the seasonal character of the epidemic, efforts require to be made to break the present coincidence between the period of the main cotton harvest and the season of the maximum development of the pest. This may be effected from the plant side and a beginning has already been made to stimulate early ripening. It remains, however, to investigate the possibilities of evolving early maturing types.

The second problem is mainly physical but here, again, comes back ultimately to the plant, its water requirement and the depth to which the root penetrates. In all its bearings the field of investigation is a wide one and the fringe has, as yet, only been touched. Apart from the purely physical aspect there is a large opening for physiological investigation.

Such problems as have been outlined in the last few paragraphs are mainly directed towards increasing the value of the yield units x, y, z, \dots . There remains the question of the price units a, b, c, \dots . Evidence is accumulating to show that the quality of a cotton is directly affected by the conditions under which the plant which produces it is grown. It is, no doubt, true that, under the normal conditions of cultivation, these conditions are sufficiently uniform and that even the extreme conditions found here diverge so little from the normal that the quality of the cotton is barely affected. Nevertheless it is not without importance to determine the point at which such effect is begun to be felt and to ascertain which are the chief environmental conditions concerned in producing the effect noted. The importance of the possession of such knowledge is emphasized if, as seems probable, cultural control aimed at the development of early maturing is to be adopted. The investigations here referred to cover a wide field of pure physiological research.

(To be continued.)

THE EXCRETION OF TOXINS FROM THE ROOTS OF PLANTS.

BY

J. N. MUKERJI, B.A., B.Sc.,

First Assistant to the Imperial Agricultural Chemist.

SOME years ago the late Mr. Fletcher, when Deputy Director of Agriculture, Bombay Presidency, put forward certain experimental evidence¹ which led him to the conclusion that crop plants excrete substances from their roots which are toxic to other species as well as to themselves. This conclusion was based upon both field experience and the results of experiments by means of water cultures, but the latter were performed with ordinary well water and without any control tests, and the method of experiment led to a considerable concentration of this water and a corresponding concentration of the salts present. This being the case, it was felt that the evidence was not conclusive and that a repetition of the experiments under more stringent conditions was desirable. With this object in view, Mr. Fletcher's scheme of experiment was repeated, with the exception that a synthetic nutrient solution was substituted for the well water, and "control tests" were introduced to check the results. The nutrient solution used was that of Knop and had the following composition:—Ca (NO₃)₂ 4 grams; MgSO₄ 7H₂O 1 gram; KNO₃ 1 gram; KCl 0.5 gram; FeCl₃ traces, dissolved in 7 litres of distilled water; the total salt concentration of this solution being 0.11 per cent.

A large number of wheat, *Cajanus* and gram seedlings were grown in this nutrient solution, and at the end of a certain period

¹ *Mem. of Dept. of Agric. in India, Bot. Ser., II, No. 3*

the solution was allowed to evaporate spontaneously until its volume was reduced to about one-eighth. The "blanks" were allowed to evaporate to one-third to one-fourth the original volume. Jars containing the nutrient solution but bearing no seedlings were also treated in an identical manner and constituted the "blanks." Seedlings were then introduced into these concentrated solutions, supposed to contain the excretions of plant roots, and the progress of crops grown in them was recorded. (For brevity these various concentrated solutions will be called "wheat water," "gram water," etc.) The observations recorded are set forth in the following tabular statement.

TABLE I.

Crops (of which progress is indicated)		CROPS WHICH HAD PREVIOUSLY GROWN IN THE WATER			Blank	Distilled water
		Wheat	<i>Cajanus</i>	Gram		
GRAM	Period (in days) after which withering commenced ..	9	8	..	7	11
	Transpiration (in grams) ..	15.4	13.8	..	9.5	17.7
<i>Cajanus</i>	Period (in days) after which withering commenced ..	15	21	21	17	39
	Transpiration (in grams) ..	15.0	22.9	17.5	21.5	32.3
WHEAT	Period (in days) after which withering commenced ..	41	36	48
	Transpiration (in grams) ..	34.3	31.0	54.0

From the above table it is evident that, in general, the seedlings grown in "wheat," "gram" and "*Cajanus*" water thrived better than in the "blank" test solution and that seedlings grown in distilled water fared best. These observations led to the conclusion that the positive results obtained in Mr. Fletcher's experiments were probably due to the concentration of the salts present in the well water and not to toxic excretions. This is confirmed by an estimation of the "total solids" in the solutions obtained in the present series of experiments, the values for which are set forth in Table II.

TABLE II.

Water	Total solids in grams per 100 c.c.
(1) "Wheat" water	0.260
(2) "Cajanus" water	0.154
(3) "Gram" water	0.226
(4) "Blank" water	0.382
(5) "Distilled" water	nil

Thus the concentration of "blank" water in which the seedlings grew the worst is the highest, whereas the best results were obtained in the distilled water, and the results obtained from the other "waters" are intermediate in character and approximately proportionate to the concentrations. These relationships are clearly shown by the graph below, where the ordinate represents the period (in days) after which withering of the seedlings commenced, and the abscissa the concentration of total solids in grams per 100 c.c. of "wheat," "gram" and "Cajanus" water. It will be observed that the withering in case of all three crops was hastened with the increase of concentration of total solids.

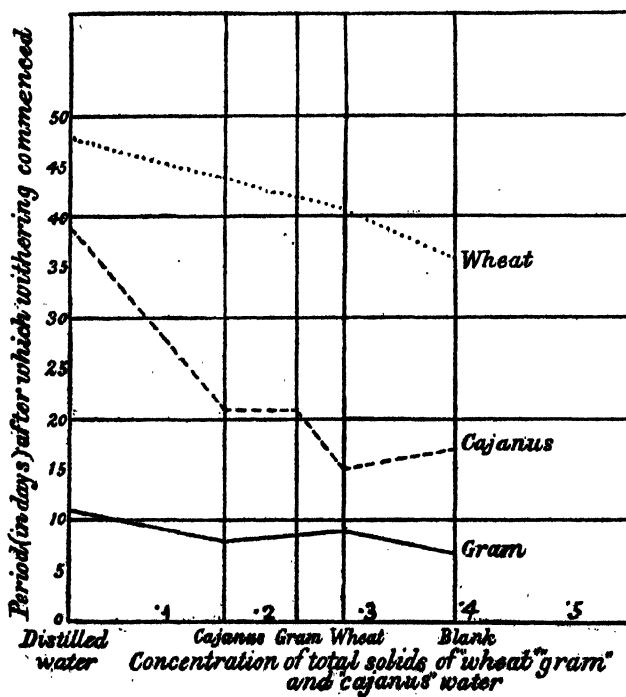

In Mr. Fletcher's original experiment, 18 to 28 litres of well water (including those added for water evaporated and transpired) was used in each case and this was finally reduced to a volume of 1.2 litres by evaporating at ordinary temperature. Some idea of the concentration of salts thus brought about can be obtained from a reference to Table III which gives the average composition of the three well waters of the Dharwar Farm (one of which was used by Mr. Fletcher for his experiment), during December 1907 to May 1908, the period covered by the experiments.

TABLE III.

Mineral salts, parts per 100,000	No. I <i>Pakka</i> well in the compound of Dharwar Farm	No. II <i>Kachha</i> well, Dharwar Farm	No. III <i>Pakka</i> well in the old area of Dharwar Farm
Calcium carbonate	19.10	15.83	7.09
„ sulphate	0.98	0.56	..
Magnesium carbonate	4.50	4.98	13.91
„ sulphate	0.29	0.53	..
„ chloride	1.61	1.45	..
Sodium sulphate	2.13	4.63	27.77
„ carbonate	2.57	5.85	15.55
„ bicarbonate	0.25	14.17
„ chloride	2.09	2.47	17.05
„ nitrate	1.19	1.23	..
Potassium chloride	0.60	0.61	0.06
„ nitrate	0.35	0.25	..
TOTAL SALTS	35.41	38.64	95.60

The concentration of total solids in the above waters varies from 35 to 95 parts per 100,000. Taking the mean concentration as 56 parts per 100,000 or 0.056 parts per 100 c.c., the concentration of the solution (about 23 litres reduced to a volume of 1.2 litres) used in the original experiment for the final water cultures approximates to (0.056×20) or 1.12 parts per 100 c.c., a value much higher than is attained in the experiments now under consideration.

The influence of nutrient solutions, covering a wide range of concentration, upon the growth of young plants has been studied

by Sachs, Knop, Nobbe, Seigart and many others. In 1860 Sachs¹ proposed the first standard formula for a nutrient solution in which he grew maize, bean, and beet, and concluded that the optimum concentration for maize appeared to be about 0.3 per cent. An investigation of the optimum concentration for a modified Knop's nutrient solution was reported by Nobbe and Seigart² for seedlings of barley and buckwheat. The total salt concentration used here ranged from 0.05 to 1.0 per cent., and it was noticed that in low concentrations (0.05, 0.1 and 0.2 per cent.) long and thickly haired roots developed, whereas in solution approaching the highest concentration, the main roots were short and the laterals and root hairs poorly developed. These writers found the period of the life-cycle nearly proportional to the total concentration of the nutrient solution employed and placed the optimum strength of the latter at 0.3 per cent. of total salts. In 1866 Wolf³ also investigated the solution employed by Nobbe for the growth of buckwheat. He concluded that a concentration of total salts from 0.1 to 0.2 per cent. was the best for Indian corn and wheat.

Studying the effect of the concentration of nutrient solutions on the growth of wheat, Breazeale⁴ concluded that concentration, independent of any changes in the chemical or nutrient properties of the solution, seemed to be important in determining plant growth. He placed the best concentration for wheat seedlings at 0.03 per cent. In 1906 Osterhout⁵ called attention to the importance of physiologically balanced nutrient solutions. He concluded, in general, that the effect of increased concentration of any given nutrient solution, beyond a certain limit, leads to a toxic effect by some or all

¹ Sachs, J. "Vegetationsversuche mit Ausschluss des Bodens über die Nährstoffe und Sonstigen Ernährungsbedingungen von Mais, Bohne und andern Pflanzen." *Landw. Versuchsst.*, **2**, 219-268, 1860.

² Nobbe, F., and Seigart, T. "Beiträge zur Pflanzenkultur in Wasserigen Nährstofflösungen. I. Ueber die concentration der Nährstofflösungen." *Landw. Versuchsst.*, **6**, 19-45, 1864.

³ Wolf, E. T. "Ueppige vegetation in Wasserigen Lösungen der Nährstoffe." *Landw. Versuchsst.*, **8**, 189-215, 1866.

⁴ Breazeale, J. F. "Effect of the concentration of the nutrient solution upon wheat cultures." *Science*, N. S., **22**, 146-149, 1905.

⁵ Osterhout, W. J. V. "On the importance of physiologically balanced solution for plants. II. Fresh water and terrestrial plants." *Bot. Gaz.*, **44**, 259-272, 1907.

of the component salts present in the solution or the further addition of new compounds.

The investigations of Sachs, Seigart, Nobbe and Wolf, indicated above, all tend to place the optimum strength of the solution at 0·3 per cent. of total salts. The strength of the solution in Mr. Fletcher's experiment works out approximately to 1·12 per cent., a concentration which no doubt would prove toxic to any plant. From Table III, the concentration of the solution, in the original experiment (if well water No. III had been used) with regard to sodium salts, works out to 0·34 per cent. sodium chloride, 0·60 per cent. sodium carbonate and bicarbonate, and 0·56 per cent. sodium sulphate. All these figures taken together exceeds the minimum weight per cent. which Coupin¹ found toxic to wheat plants in his experiment. The presence of an alkaloid, which Mr. Fletcher inferred was the character of the excreted toxin, could not be demonstrated in the present experiments, and, consequently, it is only possible to conclude that the effect which had been ascribed to toxic excretions are, in reality, due to the high concentration of salts in the solutions employed in the final stages of the experiment.

¹ Henri Coupin, M. " Sur la toxicité des composés de sodium, de potassium et de l'ammonium à l'égard des végétaux supérieurs." *Annales Agronomiques*, XXVI, 1900, 575-577.

A PRELIMINARY NOTE ON THE IMPROVEMENT OF ORANGES.*

BY

K. P. SHRIVASTAVA,

Offg. Economic Botanist, Central Provinces.

THE Nagpur "Santara" has more than a provincial reputation. It is remarkable for its juiciness, flavour, and sweetness, and is for this reason in demand all over India. Statistics show that the cultivation of this fruit has been steadily increasing, but the methods adopted by the cultivator are generally conventional, with the result that a *Citrus* survey undertaken some time ago indicated that the fruit was gradually deteriorating both in quality and yield.

In order to find out the lines of improvement best suited to local conditions a series of experiments was started in the Botanical Garden in 1913. This paper presents a brief outline of the results achieved.

The soil selected is the usual loamy soil commonly found in Nagpur District. Experience has already demonstrated to the cultivator that the soil best suited for orange cultivation is a well-drained soil containing a large proportion of lime. The experiments, therefore, aimed at gaining information regarding

- (1) Stock and nursery.
- (2) Lifting of budded plants, packing, etc.
- (3) Pruning.
- (4) Manures.
- (5) Irrigation.

* Paper read at the Seventh Indian Science Congress, Nagpur, 1920.

STOCK AND NURSERY.

Orange trees are propagated by means of budding. Seeds for raising the stocks are sown in the hot weather during March or April, and the young seedlings are fit for transplantation in the monsoon after the first showers of rain are over. The rate of development of the orange tree after planting depends to a great extent on the condition of the stock used. Healthy stocks, one-and-a-half year old, have been found to be the most suitable for budding. The fields in which the seedlings for stocks are planted should have good drainage. The root system in badly drained fields is much impaired, and plants raised in such fields seldom recover from the ill effects of water-logged conditions. Different varieties of stocks were planted out in prepared pits on the actual site of the experimental orchard in heavy black cotton soil. Settling of the soil in the pits accompanied by a heavy monsoon caused considerable water-logging. This had a depressing effect on all the stocks employed though the stunted growth in the first year from which many never recovered was much more marked in certain stocks than in others. It was found that the stocks of *Jamberi*, *Attara lime* and *Mahalunga* were hardier than those of Sweet-lime, Pumelo and Sour-lime. Sweet-lime suffered most. In Nagpur and Wardha Districts two kinds of stocks are generally used, *viz.*, (1) *Jamberi* and (2) Sweet-lime. There was a belief among orange-growers that the oranges produced on stocks of *Jamberi* were bigger in size but possessed a rough skin; while those raised from stocks on Sweet-lime produced smooth and tight skin oranges. It was reported, too, that orange trees budded on *Jamberi* grew more vigorously than those budded on Sweet-lime. Experiments were, therefore, started to see the effect of budding on different stocks. The following stocks were raised and budded in all cases from the scion of a typical Nagpur orange tree:— Citron long (*Mahalunga*), Pumelo (*Chakotra*), *Jamberi*, Wild lime, Sweet-lime.

During the first year the growth of the plants budded on *Mahalunga* was the quickest and that of Pumelo was second to it; while the *Jamberi* and Sweet-lime came next in order.

During the second year the plants budded on *Jamberi* over-took the Pumelo and equalled the *Mahalunga*. *Jamberi* continued to grow

more vigorously and now heads the whole series. The *Mahalunga*, Pumelo, and Sweet-lime now show more or less equal growth. This is the first year of bearing.

The fruits produced on *Mahalunga* are big in size and the skin is thick and loose. The segments inside are distinctly large, somewhat loose and full of sweet juice. The great defect, however, is the looseness of the skin. The fruits on *Jamberi* stock are on the whole bigger than those produced on Sweet-lime and the skin is looser and shows a greater amount of roughness. The fruits produced on Sweet-lime, although smaller, have smoother and tighter skin than the others, though there are undoubtedly other factors which affect the looseness and character of the skin.

It appears therefore that the nature of the stock plays an important part and that the future success of an orange garden is largely influenced by the early development of the stock and the type of stock employed.

LIFTING OF THE BUDDED PLANTS.

Observations in the method employed by local cultivators in lifting budded plants for planting out in the orchard indicated that these were far from satisfactory. With a view to minimize labour and trouble, the ordinary grower digs out a number of plants rapidly with a fork. He then takes them one by one, attaches a small ball of earth round the roots of each plant and ties it up with leaves. In some places the more intelligent cultivator simply digs out a small ball of earth containing only a few roots of the plant, but in this case also a great majority of the roots are carelessly cut off. It was found that the plants lifted in either of these ways took a very long time to establish themselves, while several never recovered from the injury sustained by the careless cutting away of their roots and died off or remained stunted all their life. Several methods of lifting were tried. The best results were obtained by lifting the plant by digging the earth round it in a slanting manner, so as to obtain a more or less conical ball of earth enclosing the main roots, the base of the cone being above and the apex below (Plate XXVI, fig. 1). For a two-year old plant a conical ball of earth about 6 inches high and

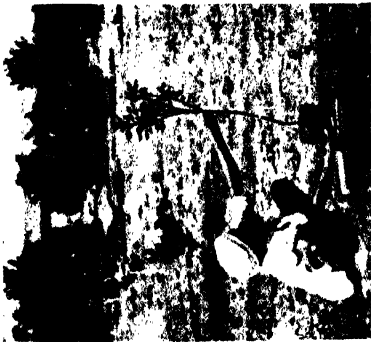

Fig. 1. A properly lifted plant from the nursery.



Fig. 2. A well pruned plant.



Fig. 3. Full-grown trees pruned as standards



Fig. 4. Full-grown trees, lateral branches not pruned.

from 3 to 5 inches broad at the base was found to be most suitable. Superfluous roots should be cut clean with sharp pruning scissors and painted with the following ointment: 3 lb. resin, 1 lb. beeswax, and $\frac{1}{2}$ pint linseed oil, melted together, and stirred till properly mixed. This ointment has been found to be very useful. It was used whenever a surface was exposed and the wound healed rapidly and prevented injury by insects, fungus, etc. Next to lifting, packing requires as much careful attention. It is necessary to tie a piece of sack cloth firmly round the ball of earth, thus securing the soil and preventing the exposure of roots by the loosening of the earth even when carried to long distances. Plants thus lifted and packed have travelled well throughout India. It may be interesting to note that a few plants were thus packed and sent to Baghdad which they reached safely and where they are now said to be doing well.

PRUNING.

The local orange is rarely touched after planting beyond the removal of stock suckers. The result is that most of the trees develop in a semi-bush form with 2, 3 or more branches on the ground level. In our experiments in the garden it was decided to grow the trees as standards, and with this object in view all lateral branches to a height of $1\frac{1}{2}$ feet to $2\frac{1}{2}$ feet from the ground were pruned off before planting (Plate XXVI, figs. 2 and 3). A certain number of trees were allowed to grow on the usual lines (Plate XXVI, fig. 4). The value of attention to pruning in the early stages of the plant and the building up of a standard in the lines indicated above, carrying 3-5 main branches at the point of forking selected, has been most marked. Early pruning in this fashion produces a well shaped tree with a much bigger fruiting tendency. In addition, fruits are more easily picked, insects have less chances of shelter, and intercultivation is not interfered with.

MANURES.

With a view to find out the best combination of manure for the orange tree at a given cost, a series of experiments dealing with nitrogenous and non-nitrogenous manures was started. Of the

nitrogenous manures, the following were experimented with: cattle-dung, green manure, castor cake, *mohwa* (*Bassia latifolia*) refuse, and calcium nitrate. The cross dressings consisted of the mineral fertilizers—superphosphate, potash, and superphosphate combined with potash. The weight of the manure given to each tree varied with the kind of manure and the combination used, but in every case the cost was kept limited to the fixed money value. As the result of the disturbing effect of the war, the prices of the manures in the market varied from year to year; but for our experiments the value was kept fixed and maintained throughout for calculations.

In the first year each tree received two annas worth manure, rising by two annas every year to ten annas in the fifth year when they were fully grown and were in bearing.

The manures were analysed and the percentage of nitrogen, phosphoric acid and potash was calculated in each case before applying to the tree in order to adjust them to the fixed money value.

As recommended by Hume, young trees were given a fertilizer containing 6 per cent. of phosphoric acid, 8 per cent. of potash, and 4 per cent. of nitrogen, while the fully grown trees received 8 per cent. P_2O_5 , 12 per cent. of potash, and $3\frac{1}{2}$ per cent. of nitrogen throughout the experiments.

The effect of the nitrogenous manures on the vegetative growth and fruiting of the trees is now quite distinct. The lines of trees which were treated with *mohwa* refuse are the most prominent. The foliage on these trees is dense, deep green, the branches are abundant, and the yield heavy. The trees treated with castor cake come second, and the rows of trees treated with cattle-dung and calcium nitrate stand third in order. Thus, to date the organic forms of nitrogenous manures fairly easily procured appear to be the most effective.

The effect of the mineral manures so far cannot be said to be clearly noticeable; but their action in the flowers and in the formation of fruits is being watched in order to deduce definite results. The experiment will thus have to be continued for a few seasons more,

and it will then be possible to arrive at definite conclusions as to the nutritive and productive value of each kind of manure used and their effect on the life of the plant.

IRRIGATION.

The economy of water is of great importance for the success of the orange garden. The right method of giving water at the proper time saves much waste in water and allows the plant to develop vigorously. The local practice of irrigation is expensive, wasteful, and not beneficial to the tree. The ordinary cultivator waters the tree by making a saucer shaped circular pit at the base of the tree. The pits are generally 4 inches to 6 inches deep and have a diameter of about 3 feet. The water stands round about the trunk of the tree, which is fully recognized as harmful to the *Citrus* and which indirectly interferes with the spreading of the root system.

Three systems of irrigation were under trial in the garden :— (1) Ring system, (2) Furrow system, and (3) Trench system.

(1) *Ring system.* A trench about a foot wide and 6 inches deep was dug parallel to the rows of trees and round each was made a ring 6 inches deep. The distance of the ring from the tree depends on the size of the tree but the approximate distance is where the shadow of the tree falls on the ground at noon. Each ring was joined to the longitudinal trench by short connecting trenches. The young orange trees were thus irrigated for four years in our garden and the system was found to be very useful and economical. After the water had soaked into the ground the rings were filled in with earth, which prevented the loss of moisture by evaporation. The amount of water given per tree averaged 40 gallons and the total amount of water for young trees in an acre comes to 30,000 to 40,000 gallons per year. The economy of water in this way in the early stages of a garden is great and we had to irrigate 5 to 6 times only from monsoon to monsoon, whereas the cultivator would have irrigated at least 20 times during the same period.

(2) *Furrow system.* As the plants become older their roots spread in all directions and it is then quite easy to irrigate by means

of furrows. This consists in making two temporary furrows by working the monsoon or ridging plough up and down between the two rows of trees (Plate XXVII, fig. 1). Water is allowed to flow slowly down a number of these furrows and the roots thus get their requisite supply of water. It is important to allow the water to run slowly. In our garden the head-channel fed at one time three furrows, each being about 200 feet long, and it took 15 hours. The total amount of water consumed was 60,000 gallons for 132 trees. In a year from monsoon to monsoon the trees received only 5 to 6 irrigations. After each irrigation, as soon as the soil becomes workable, the bullock-hoe (*bakhar*) is worked and all the furrows are obliterated. In this way the soil beneath the trees is kept well mulched and clean and free from weeds. This method entails a bigger watering at each application but the interval between waterings is longer. When irrigation is from a well or from a source where the time during which the canal is open is not too short it is quite satisfactory.

(3) *Trench system.* It was noted, however, that the Irrigation Department, in tracts near Nagpur where orange cultivation was likely to extend under canal irrigation, preferred to supply a large bulk of water for a short time. Though the second system can be used under these circumstances, provided that the cultivator can open up sufficient furrows from his head-channel to deal with the water, in many cases the regulation of a large amount of water is difficult. In such cases it was decided to irrigate by means of straight trenches about $1\frac{1}{2}$ feet wide and about a foot deep made across the slope of the garden half way between the lines of trees (Plate XXVII, fig. 2). In cases in which the land was not practically level, the trenches had to be terraced in order to keep a uniform depth of water throughout its length. In this way each tree gets an equal quantity of water. This system is quite easy to work. In places where the cultivator receives canal water for a fixed number of hours it is distinctly to his advantage to fill in his trenches and to let the roots of the trees gradually absorb the water. As compared with the furrow system, the irrigations have to be given with greater frequency though the amount utilized in each watering



Fig. 1. Furrow system of irrigation.



Fig. 2. A trench running between two rows of trees.

is less. The total amount of water consumed was 45,000 gallons for 132 trees.

These trenches can be used as drains in the monsoon, a most important factor in the Central Provinces where more trees are spoilt by lack of drainage than any other cause. The one disadvantage in this system is a slight one found in intercultivation. This, however, was easily overcome by using the small double hoe used in cotton rows—one bullock walking on either side of the trench. A single bullock hoe would be even better.

THE "TOP-WORKING" OF INDIAN FRUIT TREES.

BY

W. BURNS, D. Sc.,
Economic Botanist, Bombay ;

AND

P. G. JOSHI,
Superintendent, Ganeshkhind Botanical Gardens, Kirkee.

By the term "top-working" we mean the renovation of the whole of the top of a tree by inserting scions on the existing branches, and then arranging that these scions grow while the old branches of the tree are removed. The method is not new. It has been described in various American publications, for example, in Wester's "The Mango"¹ and in Rolfs' "Mangoes in Florida."² We believe, however, that the experiments here mentioned are the first of their kind in India.

The problem first presented itself to us in the form of the well-grown but useless mango tree, useless because its fruit was poor and turpentine. Experiments had already been made in this Presidency in crown-grafting such trees, but with a very small percentage of success. Text-fig. 1 shows what is meant by crown-grafting. The whole top of the tree is cut off, and scions are

¹ *Philippine Bureau of Agriculture Bulletin* 18.

² *University of Florida Agricultural Expt. St. Bulletin* 127.



Fig. 1. Tree pruned for top-working with pots attached for the inarching of scions.

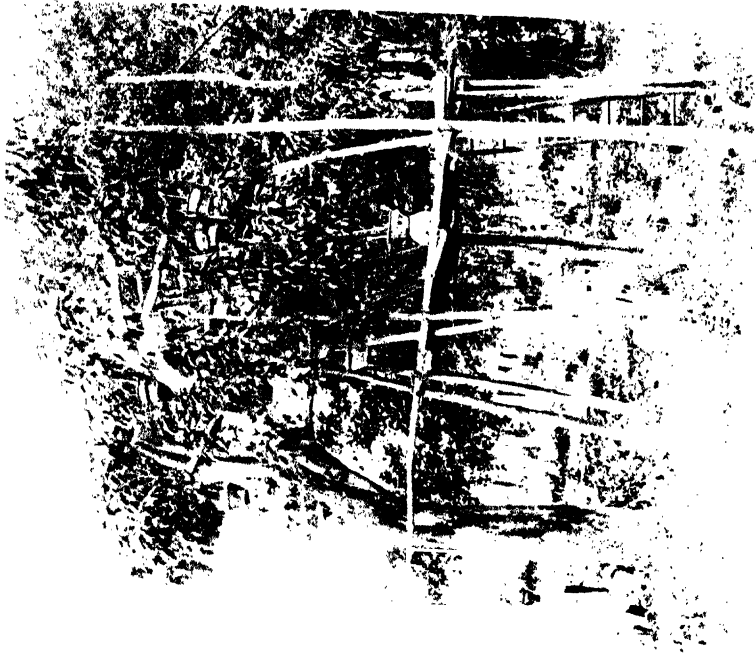

Fig. 2. Top-working in full swing.

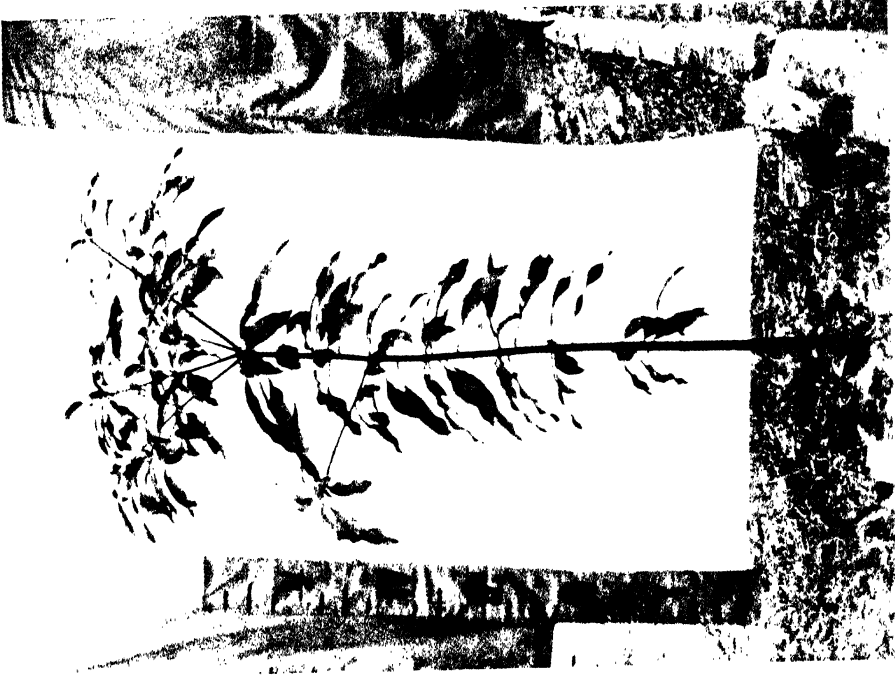

Fig. 2. A well grown mango seedling growing where its seed was planted.



Fig. 1. The top completely renewed.

inserted between the bark and the wood in the manner shown. As can be easily imagined, the cutting off of the whole top of a well-grown tree is a considerable shock to the plant. Moreover, the fact that the scion cannot at once establish its water connection

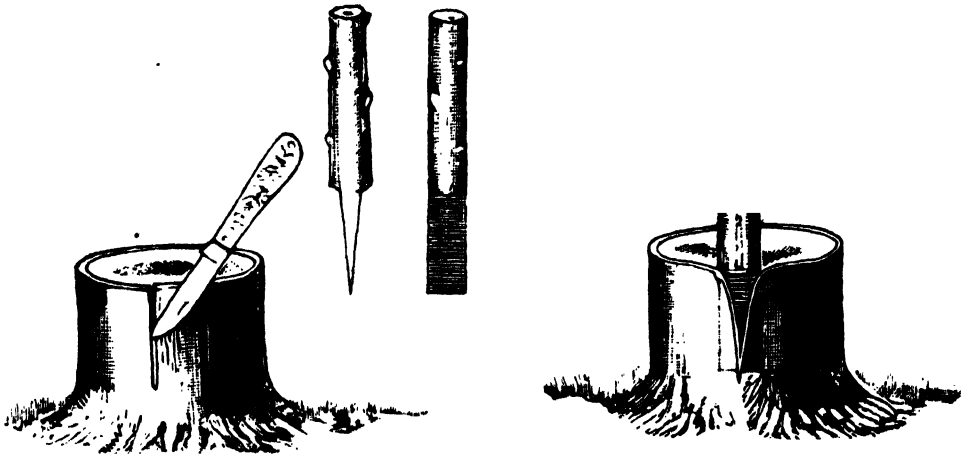

Fig. 1. Crown-grafting.

with the stock and yet has to be out in the field exposed to the sun, and only ineffectively protected by any artificial shading material, makes the likelihood of union very remote.

The method of top-working meets both these difficulties. To begin with, the top of the tree is not entirely removed. Branches may have to be pruned off, to reduce the head, or to stimulate the production of young shoots on which to graft, but the drastic decapitation of the crown-grafting method is avoided (Plate XXVIII, fig. 1).

Second, the scion is not taken away from its original water connections until the new are fully established. In other words, the scion is inarched from a live grafted plant on to the stock, and this means that the scion is attached to its own original plant until union occurs. Text-fig. 2 shows inarching, and Plate XXVIII shows a tree with the inarching going on. Fig. 1 on Plate XXIX is the completely renewed tree.



Fig. 2. Inarching.

The following are a few examples of top-working as done by one of us.

A country mango tree in Bassein on the coast near Bombay, of unknown age, but probably over thirty years old, was heavily cut back on March 6, 1912. Many new shoots sprang up from the stumps, and on these were grafted scions of good varieties on May 22, 1912. The grafting was done by inarching from plants in small pots tied to the tree in various places. On 1st November, 1912, further grafting was done from the now established scions on to new shoots of the stock. Out of a total of 40 scions, 3 flowered in June 1914. As the first and second sets of scions were not distinguished it is impossible to say to which the flowering scions belonged, but it shows that, by top-working, flowers can be got 14 to 20 months after operation. The pot-plants from which these scions were taken did not flower.

The first real crop was got from the tree in June 1916. There were 38 fruits of four varieties. These varieties had all retained their own characters although grafted on the same stock plant.



Fig. 2. The mango seedling with its top renewed and growing vigorously.



Fig. 1. The mango seedling inarched (note the tape (marked with X) covering the points of grafting.)

Top-working was also done on wild trees belonging to cultivators in some of the coastal districts of the Bombay Presidency, with considerable success, as will be seen from the following letters from these men.

Mr. R. V. Bam, Thana District, writes :

"As for top-working I prefer it to side-grafting, especially because it requires very little care after the grafts are removed from the trees" (*i.e.*, after the union of the scions has taken place and the pot-plant that was tied to the tree has been removed.—*Authors*). "The tree is not required to be watered and it requires no protection from cattle, the grafts being beyond their reach. The only care required is to remove the new shoots from ungrafted branches. It is the most successful method of converting ordinary trees into grafted ones."

Mr. Gopalrao Mehendale of Belapur says :

"In my opinion the top-working system is very good. My top-worked trees are growing well. Those who have got wild-mango trees can do best by top-working them. It is only at the beginning that the work requires constant attention."

Top-working for the conversion of useless wild trees into good bearing trees can also be applied with success in the case of *Zizyphus* species. *Mimusops hexandra* can be top-worked with scions of *Achras sáputa* (the sapodilla plum or *chiku*).

Another application of top-working is in the starting of new mango plantations. It is a matter of importance to get strong, deep-rooted, straight-stemmed trees. This is seldom got if pot-plants grafted in the pot are afterwards planted out. A better method is to plant the seeds of the stock plants in the field in the place where the tree is wanted and afterwards graft on to the stock when sufficiently grown. Plate XXIX, fig. 2. shows such a seedling of natural shape and strong straight stem. Plate XXX, fig. 1, shows top-working on to each branch of the head, and the second figure on the same plate shows the finally altered tree.

Still another application is that of getting an early flowering from scions whose character one wishes to test. Suppose we have hybridized two varieties of fruit tree. We have the seeds, and grow a hybrid seedling. Now it will take, perhaps, five years for this to come into flower and show us what its fruit is like. We can greatly shorten this time by grafting the seedling (top-working it) on to the well-developed branch system of an adult tree. In the first case of top-working quoted in this paper, flowering took place on the tree where it did not take place in the pot-plants from which the scions were taken. In another set of experiments, seedlings of guava were, in the Gancshkhind Gardens, grafted on to well-grown trees of 5 years old, on March 20, 1919. The scions flowered on December 27, 1919, and the seedlings in pots, afterwards planted out into the ground, have not yet flowered.

Similar results have been got in America.¹

¹ Oliver, G. W. "The Seedling-Enarch and Nurse-Plant Methods of Propagation." *U. S. Bureau of Plant Industry Bulletin* 202.

IMPROVED FURNACES FOR *GUR* MANUFACTURE.*

BY

G. K. KELKAR, B.AG.,

Extra Assistant Director of Agriculture, Bhindara, Central Provinces.

FURNACES play an important part in cane industry, as much depends upon their efficiency. A cultivator may take a good deal of trouble and invest large sums of money in producing an excellent crop of sugarcane; but if he is a little slack in adopting improved methods of cane-crushing and *gur* manufacture, he might incur a great loss.

It is now a well-known fact amongst cane-growers that if they crush their cane by wooden mills, instead of iron ones, they lose 20 to 25 per cent. juice after every 100 lb. of cane. With a good crop this loss may amount to Rs. 125 to Rs. 150 per acre per season. By demonstrations and comparative trials made in cane-growing tracts, the cultivators are now so convinced of the superiority of the iron mills over the wooden ones that the latter are now being entirely ousted and their place taken by iron cane-crushing mills.

What is true with the mills is also true with the furnaces. An efficient furnace means saving in money and time and production of a finer quality of *gur* which will fetch better rates in the market.

Cane-growers in these provinces used to boil their juice on most primitive and inefficient furnaces before the attention of the Agricultural Department was drawn to this question. This furnace consists of a pit 4'-6" in diameter and depth. A feeding hole 2' × 1'-6" is kept in the front. For want of any arrangement for the draught, ash pit, and exit passage for smoke and hot gases, the

* Paper read at the Seventh Indian Science Congress, Nagpur, 1920.

working of this furnace is very defective. A trial boiling taken on such a kind of furnace showed that it required $4\frac{1}{2}$ hours to boil 500 lb. of juice. The quantity of fuel used was simply enormous. In the first place, firewood was utilized for the boiling. Then the megass and trash was exhausted; but still the boiling was not complete. Consequently the stock of fuel had to be supplemented by feeding *til* (sesamum) stalks. As it took such a long time to boil a small quantity of juice, the quality of the finished product was distinctly inferior. In comparison with this type of local furnace the introduction of the Poona furnace was looked upon as a decided improvement. The cultivators at once appreciated its obvious advantages at demonstrations carried out by the department. There are three main points of advantage in this furnace, *viz.*, the ash pit, draught passage, and exit hole for smoke. Unlike the country furnace, this furnace is double storied. It is 7' in diameter. The ash pit is 3' in diameter at surface level. It is dug up to a depth of $3\frac{1}{2}$ ' and broadens as it goes deeper so that the diameter at the bottom remains 5'. A narrow draught passage $1\frac{1}{2}$ ' wide communicating with this pit opens out on one side of the furnace at ground level, through which the draught of air is constantly supplied to the burning fire. Over the top of the ash pit is put an iron sheet with a hole 9" square in the centre. The upper wall of the furnace is 3'-6" in height. An opening 1'-6" \times 2'-6" is kept in the front for feeding fire. To make the working of this furnace more effective, an exit hole 9" in diameter is kept at the left side of the feeding mouth. This communicates with a chimney about 6' high. The working of this furnace was so successful that it has ousted the local furnaces wherever demonstrations showing comparative trials were held. It required no extra fuel as all the boiling could be done on megass and trash, which means a saving of at least 15 cartloads of fuel worth Rs. 20 per acre of cane. It boiled the same quantity of juice in nearly half the time than that required for the local furnace. The quality of *gur* was, therefore, considerably improved. With all these obvious advantages, it is no wonder, therefore, if this furnace has been adopted by all the cane-growers who have seen its working side by side with their local furnace.

The Sindewahi furnace evolved on the Sindewahi Farm, however, is even a far greater improvement over the Poona furnace. From trials made it has been conclusively proved that this furnace is simpler, cheaper, more efficient and economical than the Poona furnace. The construction of this furnace may be described as follows :—

Select a level piece of ground somewhere adjoining the cane area to save extra expenses of carting cane. For a pan of 7' diameter dig a pit 6'-6" in diameter and 18" deep with sloping sides, so that the diameter at the bottom will remain 4'-9". Construct a mud wall in the centre, 1' in height and 4" broad, leaving 6" on both sides for smoke and hot gases to gain access to the passage leading to the chimney. The most important part of this furnace is the grating over which fuel is fed and through which the draught is supplied. It should be made of $\frac{1}{2}$ " round iron bars, each 20" in length, fixed up $\frac{1}{4}$ " apart to two pieces of 1" broad flat iron. The size of the grating should be 14" \times 20". It should face towards the direction from which wind generally blows. It should be fixed in such a way that its bottom touches the lower rim of the furnace whilst the upper edge is fixed in a slanting direction at a point 8" from the upper rim at the surface level and 3" deep. This leaves an opening 14" \times 7" between the pan and furnace for feeding megass.

A perpendicular cut is made from the lower rim of the grating, 1'-6" deep, 15" wide and 3" long. In continuation with the upper edge of the grating, flat stones should be fixed up to a length of 3'. These will cover up the air passage and allow space for the feeder to sit upon. A sloping air passage 5' \times 2' communicates with the passage below the grating, and thus gives a continuous supply of draught to the burning megass.

The outlet for smoke and hot gases is situated behind the mud wall just opposite to the grating. Its size is 15" \times 7". This opening is continued to a distance of 8' where a chimney 1' \times 9" is constructed. The height of the chimney should be at least 8'. The passage for smoke is closed by covering with bricks or stones flush with the ground, taking care to see that no smoke gets out from any joint.

Comparative trials have shown that this furnace has several advantages over the Poona furnace.

(1) This furnace costs very little. The grating is the only part which has to be got made by the village smith. With normal prices of iron, this furnace will not cost more than Rs. 5. A *kutchra* Poona furnace costs not less than Rs. 10, including the cost of iron sheet. Such a furnace built in *pucca* bricks costs Rs. 25.

(2) It effects a considerable saving in fuel as all the boiling can be done on megass alone, there being some balance left out even of this stuff at the end of the crushing season. The whole of the trash can, therefore, go into the manure pit or be ploughed into the cane land. From experiments carried out it has been proved that the manurial value of trash from an acre of land (about 5 tons) is equal to that of 30 cartloads of cattle dung. From this point of view, the Sindewahi furnace is of far greater importance, as cattle dung is getting scarce day by day and its price is rising by leaps and bounds. By adopting this furnace, the cane-grower can depend upon his trash to supply the necessary quantity of bulky manure, which he can supplement by concentrates like oil-cakes or nitrates at a later period in the growth of the crop.

(3) It totally dispenses with the necessity of having a strong man for feeding fire. The megass can be fed by a boy or girl by putting in handfuls at a time. The feeder can sit up in an easy position all the while that the boiling continues. Fire-feeding which was so long looked upon as the most difficult task in *gur* manufacture can now, with this furnace, be considered as an easy job which can be managed by anybody.

(4) It boils the juice in comparatively less time than that required for the Poona furnace.

(5) The lifting of the pan when the *gur* is ready is much easier than in Poona furnace.

From all these points, it is obvious that the Sindewahi furnace is a decided improvement over the Poona furnace in several respects, *viz.*, simplicity, cost, and efficiency. This furnace has been introduced in the cane-growing tracts and is being looked upon everywhere as a boon to the cultivators.

**GUR-MAKING FROM THE JUICE OF THE DATE-PALM
(*PHŒNIX SYLVESTRIS*) IN THE THANA
DISTRICT OF THE BOMBAY
PRESIDENCY.***

BY

V. G. PATWARDHAN, B.A., B.Sc.,

Lecturer, Agricultural College, Poona.

Gur-making from the date-palm juice is not carried on on an industrial scale by the people of the Thana District as in Bengal and Madras Presidencies. Three or four years ago this work was taken up by the Bombay Agricultural Department, and investigations were made in connection with *gur* making from the date-palm juice and also in connection with the improvement of the quality of *gur* in colour, crystalline consistency, etc. The experiments were conducted at Sanjan and Tadgaum in the Thana District.

In the jungles and also on the coast-line of Thana District, date-palm trees grow in abundance but no economical use of them is made by the people. Only some trees out of an enormous number are tapped for toddy (fermented juice). Hence there is ample scope there to start an industry of *gur* or sugar-making from the juice of date-palm trees. A number of trials were made for preparing *gur* from the date-palm juice under different conditions. There are two collections of juice: one is the night collection (removed in the morning) and the other is known as the day collection (removed in the evening). The juice of the night collection is clear, colourless, and transparent, when collected in new pots after washing the exposed part of the tree. It resembles the juice of coconut both

* Paper read at the Seventh Indian Science Congress, Nagpur, 1921.

in appearance and taste though it is sweeter than the coconut juice. This juice is known as *nira*, and is free from fermentation and hence can be used for *gur*-making. If the juice is kept exposed even for a short time, the acidity increases and fermentation sets in very rapidly with the increase of temperature. This juice is known as sweet toddy which takes two days to complete the process of fermentation when it becomes real toddy of drinking. Neither the *sweet* (fermenting juice) nor the *real* toddy (fermented juice) is of use for *gur*-making. The day collection is always fermented and is never used for *gur*-making. The *nira* (unfermented juice of the date-palm) has a decided advantage over the juice of sugarcane for *gur*-making inasmuch as the skimmings from the date-palm juice when boiled are trifling. There is no great change in the colour of the boiling juice till it reaches the *ghagara* stage (when frothing ceases), after which the colour changes from the reddish yellow to dark red or brown.

From *nira* the *gur* easily sets to solid crystalline consistency and gets the characteristic dark brown colour. The *gur* smells slightly of the date-palm juice and its taste also differs from cane *gur* to some extent. The *gur* prepared at Sanjan compared well with low quality cane *gur*. The average proportion of *gur* to juice was one to ten, *i.e.*, 10 per cent. The percentage of sucrose in the juice varies from 7 to 10. As fermentation proceeds, reducing sugars increase to as much as 50 to 60 per cent. of the total sugars within 10 hours. In a good sample of juice, the reducing sugars do not exceed 1.8 per cent. A large number of trials were made to have a solid crystalline *gur* from the date-palm juice. The investigation was carried on mainly with the following two points in view :—

- (1) To get the best juice (*nira*) suitable for *gur*-making, and
- (2) to get *gur* of solid crystalline consistency.

In order to secure the first point, earthen pots were used for the collection of the juice. Some of the pots were lime-coated, some were smoked and some new, while some were treated with formalin (six drops of 40 per cent. formalin per pot) and some with chloroform (10 drops per pot). In every case proper

care was taken to clean the cut surface of the tree with a view to avoid contamination. The pots were suspended on the tree rather late in the evening and the collections were removed early in the morning at about 5 A.M. The boiling of the contents of the pots subjected to different treatments was done separately in open iron pans at 7 A.M., and *gur* was prepared in the same way as with cane juice. The best temperature for ripe boiling was found to be 108° to 110°C.

The acidity of all the collections was determined before they were taken to the pan for boiling. Formalin was found to be the best preventive of fermentation, though the increase of acidity in others was not very high (only 0.06 gramme of caustic potash was required to neutralize 100 c.c. of juice). The results of all these experiments were as follows:—

(1) The juice treated with formalin gave solid *gur* of good grain.

(2) The juice treated with chloroform gave solid *gur* but with no grain.

(3) The juice with other treatments gave only semi-solid *gur*.

In the other set of experiments the acidity was neutralized by lime water and sodium carbonate separately, and the result was that no solid *gur*, but only a dark sticky mass, was obtained.

Slow or rapid boiling was found to have no great effect on the quality or nature of *gur* obtained. Our experience seemed to indicate that continuous stirring, till the point of solidification or setting, prevented the *gur* from becoming sticky. The following precautions were found to be essential to getting juice fit for *gur*-making.

(1) Special care was required to clean the exposed surface of the tree and also the slit.

(2) The leaves down which the oozing juice trickles into the pots should be fresh every day and should reach the bottom of the pot.

(3) Fresh pots should be used every day or the used ones should be burnt or smoked before they are used a second time.

(4) Pots should be fixed late in the evening and should be removed early in the next morning (one hour before sunrise).

(5) Fermentation of the juice on account of exposure, etc., should be avoided by adding some such preservative as formalin.

In February 1918, another set of experiments was conducted on a large scale in which the Bengal method of tapping the trees was practised. This method differs from the Thana method in three chief points:—(1) Surface cutting as against deep cutting, (2) collecting the juice in smoked pots, and (3) collecting the juice for three successive days and then allowing the trees to rest for two days so as to harden the exposed surface.

The juice obtained by this method gave slightly different properties with regard to acidity, alkalinity, and fermentation. The pure juice, instead of being acid, was found to be amphoteric. The juice collected over-night and tested in the morning was clearly alkaline to methyl orange and acid to phenolphthalein. The Thana method was improved on the model of the Bengal method except in regard to that of cutting. Several experiments were performed on practical and economic lines to get *gur* from the date-palm juice collected from trees tapped both by the Bengal method and the improved Thana method respectively. These experiments proved successful in giving us solid *gur* of good grain. But the *gur* obtained had a dark brown colour characteristic of the date-palm *gur*. This unattractive colour lowered the value of the *gur* to an appreciable extent and led us to devote our energies to find out means to improve the colour of *gur*.

It is well known that when alkalies are boiled with reducing sugars, black-coloured products are formed. This suggested to us that the distinctly alkaline nature of the juice must be the cause of the darkening of *gur*. Hence, to improve the colour of the *gur* the following scheme was planned:—

(1) To find out the extent of alkalinity or acidity together with their variations in different samples.

(2) To see the effect of boiling on the alkalinity and acidity.

(3) Neutralization of the alkalinity by various organic acids in different proportions and the effect on the colour of *gur*.

Samples of juice from different plants were separately collected under various conditions and their alkalinity and acidity were determined. Acidity is expressed in terms of grammes of caustic potash per 100 c.c. of juice, as determined by using phenolphthalein as the indicator, and alkalinity is expressed in terms of grammes of sulphuric acid per 100 c.c. of juice as determined by using methyl orange as the indicator.

	First day's collection	Second day's collection
Alkalinity	0.086 to 0.151	0.047 to 0.165
Acidity	0.019 to 0.038	0.014 to 0.053

The slight acidity that is present in the fresh juice changes, and the juice, when made to boil, becomes alkaline in reaction to both phenolphthalein and methyl orange. This indicates the presence of some alkaline bicarbonates and the formation of some alkaline salts from alkali metals and organic acids. The alkalinity may also be due to the presence of some basic nitrogenous organic compounds.

From different samples of juice, *gur* was prepared separately. Formalin and smoke treatment gave better results than lime or no treatment. The keeping quality of the juice was determined from the amount of fermentation and acidity formed.

In working out the second part of the scheme the organic acids taken for the neutralization of the alkalinity were citric, tartaric and acetic acids. The samples of juice taken for various trials of *gur*-making were first analysed as to the amount of alkalinity and acidity present. The alkalinity was partly or wholly neutralized by the action of the required amount of citric acid before the juice was boiled. Each sample was divided into

four parts consisting of two litres. One was boiled without any treatment to compare with the others under different treatments of acids. That trial which gave the best results was done on a large scale.

We found out that the neutralization of alkalinity by citric acid, partly or wholly, always gave light and bright colour to the *gur* though differing in crystalline consistency. As the result of the final trials, it was found that the addition to the juice of one-fourth the amount of citric acid required to neutralize the alkalinity, before the juice is taken for boiling, always gave lighter and brighter colour to the *gur* with good grain fairly comparable with the best Poona yellow-coloured cane *gur*.

Gur samples from the juice treated with acetic acid were rather soft and sticky with no good taste, although the colour was light.

Gur samples from the juice treated with tartaric acid were solid and crystalline. There was some change in the colour, but it was towards deep red and not towards light and bright yellow colour (the one which is so much desired).

From calculations made in accordance with the above results it was found that for eighty-four gallons of juice about a pound of citric acid would be necessary to get the best quality of *gur*. Taking that 7 per cent. of citric acid is present in the lemon juice, about 17 pounds of lemon juice would be necessary for 100 gallons of date-palm juice.

The work of getting lighter coloured *gur* by the use of citric acid was done independently (an original idea in February 1918) and long before the publication of a similar work done by Messrs. Annett, Pal and Chatterjee (*Mem. of the Dept. of Agric. in India, Chem. Series, Vol. V, No. 3, September 1918*). The detailed report of the work will soon be published as a Bulletin on toddy by the Deputy Director of Agriculture for whom the work was done.

The results about the analyses and other important determinations are given in the tabulated statements below.

Analyses of gurs treated in different ways.

Kind of treatment	PERCENTAGES ON GUR				Alkalinity in terms of grammes of sulphuric acid per 100 grammes of gur with methyl orange	Acidity in terms of grammes of caustic potash per 100 grammes of gur with phenolphthalein
	Moisture	Ash	Non-reducing sugars	Reducing sugars		
Dark-coloured gur prepared on a large scale by ordinary process and put in blocks	9.30	1.55	78.35	5.50	0.763	0.387
Dark-coloured gur prepared on a large scale by ordinary process and put in earthen pots ..	9.33	1.80	70.75	4.60	0.477	0.339
Semi-solid gur by ordinary process	7.35	0.572	0.290
Solid gur with no treatment (on a small scale) ..	5.60	0.477	0.290
Gur with one-fourth the amount of citric acid required to fully neutralize the juice	4.95	0.858	0.290
Gur with one-half the amount of citric acid required to fully neutralize the juice	7.05	0.763	0.677
Gur with whole amount of citric acid required to fully neutralize the juice..	3.95	0.572	0.677
Gur with no treatment ..	5.80	0.477	0.290
Gur with small amount of tartaric acid	5.75	0.668	0.242
Gur with one-third the amount of tartaric acid ..	5.80	0.667	0.484
Gur with acetic acid	9.85	0.572	0.677

Effect of boiling on the alkalinity and acidity of the juice.

	Colour	(INDICATOR METHYL ORANGE)	(INDICATOR PHENOLPHTHALEIN)	(INDICATOR PHENOLPHTHALEIN)
		Alkalinity in terms of grammes of sulphuric acid per 100 c.c. of juice	Alkalinity in terms of grammes of sulphuric acid per 100 c.c. of juice	Acidity in terms of grammes of caustic potash per 100 c.c. of juice
No. I				
Fresh juice (composite sample) ..	Dull	0.119	..	0.048
At scum forming (Temp. 70 to 80°C.) ..	Brownish	0.119	0.014	nil
At boiling (Temp. 98°C.) ..	Brownish	0.109	0.018	nil
No. II				
Fresh juice (composite sample) ..	Clear	0.095	nil	0.033
At boiling ..	Brownish	0.095	0.018	nil
No. III				
Fresh juice (composite sample) ..	Dull	0.104	nil	0.038
At boiling ..	Brownish	0.104	0.018	nil

After boiling, the juice became alkaline to phenolphthalein (which was acid before to the same indicator).

THE INFLUENCE OF STOCK AND SCION AND THEIR RELATION TO ONE ANOTHER.*

BY

S. H. PRAYAG, M.AG.,

Of the Department of Agriculture, Bombay.

INTRODUCTION.

IN foreign literature much has been written regarding this subject. Knight¹ gave an account of the injurious influence of the plum stock upon the apricot as far back as 1823. An article also appeared in *Gardener's Chronicle* in 1853. Fuller treats this subject at some length in his book on the "Propagation of Plants" written in the year 1887. Amongst the modern and leading horticulturists, Bailey has dealt with this question in his "Nursery Book."

But the fruit plants dealt with by these writers are unsuitable to Western India. In the Bombay Presidency there is very little on record bearing on the above subject, though work on it was commenced in the Ganeshkhind Botanical Gardens in 1909. In this article it is intended to put together all the available material regarding some important fruit trees and other plants of importance, with a view to invite suggestions and criticism.

The union by grafting may be made between plants of different varieties of the same species or of species of the same genera. It may also be made between plants of different genera of the same natural order. The method may be employed for the following reasons :—

- (1) To induce early bearing.

* Paper read at the Seventh Indian Science Congress, Nagpur, 1920.

¹ *Horticultural Transactions*, Vol. V, p. 287.

- (2) To produce superior varieties.
- (3) To encourage strong and vigorous growth of plants.
- (4) To multiply plants of those species which fail to seed or which cannot be propagated by any other vegetative methods of reproduction.
- (5) To dwarf the size of plants.
- (6) To minimize the number of thorns.

Let us now consider the effect of different stocks on the scions.

PREFERENCE OF SOME STOCKS TO PARTICULAR SCIONS.

In order to ascertain the best stock on which to bud any variety of orange, pumelo, lemon, etc., trials were made in the Ganeshkhind Botanical Gardens, since 1909, by Mr. H. P. Paranjpe, Assistant Economic Botanist, in which all the available varieties of *Citrus* in the Deccan were budded on the following stocks, viz., *Mahalunga* (*Citrus medica*, proper), *Jamberi* (*Citrus medica*, var.), orange, and *Reshmi* orange (*Citrus aurantium*). The following results were obtained :—

The Nagpur and Poona oranges, as also Ladoo and Kawla oranges, were found to be indifferent in growth on *Mahalunga* stock. *Mosambi*, *Mahalunga*, *Sakhar-limbu*, *Jamberi* and Pumelo plants were in good condition on this stock. If conclusions are to be drawn from seven years' trials it may be said that scions of hardier varieties with thick bark from large round stems did well on *Mahalunga* stock.

If the *Mahalunga* stock preferred some particular scions to others, the *Jamberi* stock welcomed all. The bark of *Jamberi* is very mucilaginous and separates more easily from the wood below than that of *Mahalunga*, and this seems to be one of the reasons why the *Jamberi* is preferred as a stock plant.

The orange has not been found to be a good stock especially for thick-skinned scions such as Pumelo, *Sakhar-limbu* and *Mosambi*, as the part above the insertion of the bud quickly dries up after pruning and turns black.



Fig. 1. Shows the tall and vigorous growth of Kagdi lemon (*Citrus medica*, var. *acida*) plant on Jambéri stock (*Citrus medica*, var.).



Fig. 2. Shows the bushy habit of growth of Kagdi lemon (*Citrus medica*, var. *acida*) plant on Mahalunga stock (*Citrus medica*, var. *proper*).

INFLUENCE OF STOCK ON THE VIGOUR, HABIT OF GROWTH
AND YIELD OF THE SCION.

Apart from the question of the more ready union made by some stocks, there is another and most important question. This concerns their capacity to increase the hardiness of the scion. The following are examples :---

“ With regard to mangoes¹ it was found that the Bombay grafts were seriously affected by frost, each year, when grown at Pagara. The *khuds* and ravines of the Pachmarhi Hills are full of wild mangoes and it has now been found that if the Bombay varieties are grafted on the wild Pachmarhi seedlings the resulting trees, without deteriorating in quality, are quite frost-resistant, a fact which is worth noting by many growers in the Central Provinces, who are troubled by the annual destruction caused by frost.”

In the Ganeshkhind Botanical Gardens, during the flood of 1912, the *Mahalunga* plants on their own roots were greatly affected. Leaves on the parts that had been submerged withered and dropped. The twigs bearing such leaves also succumbed in some cases. But the *Mahalunga* plants on *Jamberi* stocks in another submerged part of the same garden did not suffer in any way.

These two examples indicate that the stock has a definite ability to communicate to the scion its own power of resistance.

Besides, the habit of growth of the plants is affected in a marked degree by the stocks used. A tall-growing variety induces the scion to come up to a good height in contrast to a scion grown on a bushy stock. In the Ganeshkhind Botanical Gardens six plants of each type of *Citrus* were planted in 1910 on stocks of *Jamberi*, *Mahalunga*, *Reshmi* orange, and orange. In this plantation it is peculiar to note that plants on *Jamberi* stock are decidedly superior, both in height and appearance, to those on other stocks, and that plants on *Mahalunga* stocks are decidedly bushy in habit as compared with those on other stocks (Plate XXXI). Sorauer² says : “ It

¹ *Agricultural and Co-operative Gazette, Nagpur, Vol. IX, September 1915, p. 15.*

² “ *Treatise on the Physiology of Plants,*” p. 195.

is well known that certain stocks have a very pronounced effect upon the habit of growth of the scion. Apples grafted on Paradise stock or dwarf stock (*Pirus præcox*) remain of short stature and often produce flowers in the year following the grafting. Grafted on the Doucin, the varieties become bigger and fruit later; on the crab-apple the tree retains a normal growth, but the crown does not produce flowers for a considerable time."

The following is another example: *Crescentia alata* is a plant belonging to the order Bignoniaceæ the flowers of which scarcely set fruit in Poona. Only once in the course of ten years has it produced two fruits in the Ganeshkhind Botanical Gardens, but these dropped down before they became fully ripe. Vegetative methods of reproducing this plant, viz., by *gooty*, cuttings, and layerings, adopted by the writer in the rains of 1913, failed, though a considerable amount of callus was formed at the cut ends. Hence, recourse had to be taken to reproduce these plants by grafting on a sister species, viz., *Crescentia cujete*. Three grafts of these were obtained in 1914 but all of these are making very slow growth, scarcely attaining three feet and remaining very dwarf in size, thus indicating the effect of stock on the growth of the scion.

Regarding the influence of stock on the productive capacity of the scion, very little information is at hand. The experiments on grapes conducted by Mr. H. V. Gole, the well-known grape grower of Nasik, and mentioned in the "Agricultural Journal of India," Vol. XIV, Pt. 1, pp. 119-120, show that *Phakadi* variety, which is a shy bearer, if grafted on *Bhokari*, a prolific bearer, has been found to give an extra yield of 2 lb. per plant.

In the Ganeshkhind Botanical Gardens the *Phakadi* scions were inserted on *Bhokari* in the rains of 1915. Six plants of these are now in the ground. They have not as yet flowered.

UNDESIRABLE COMBINATION OF STOCK AND SCION.

So far I have dealt with the influence of stock on the scion, but there are cases in which the affinity between stock and scion is slight. If the stock and scion plants have different periods of dormancy or activity, or if one be a tree and the other a small plant,

and if such plants, though belonging to the same genera, are grafted, the result is that the active part temporarily grows but soon fails, ultimately causing the death of the tree. The following are some of the examples:—

On 27th May, 1913, ten *enarch* grafts of *Neem* (*Azadirachta indica*) were made on *Bakan* (*Melia Azedarach*) stocks by the writer. Besides, 25 buddings of the same were done on *Bakan* stocks in May and June 1913. Nine grafts and five buddings in all succeeded, and these were planted on 17th July, 1914. These grew well for a year when two grafted and three budded plants withered. One budded plant flowered and fruited in March 1915 and 1916. The fruits had the normal characters of the *Neem*. This plant as well as other budded plants withered in June 1917. By this time only four grafted plants were doing well, but they had formed a big knotty excrescence at their grafted portion with shoots from the stocks constantly appearing. This knotty excrescence seems to arise from the obstruction which the descending sap of the *Neem* tree meets at the junction with the *Bakan* stock, for the effects produced upon the growth of the tree are similar to those which occur when the descent of sap is impeded by a ligature.



Formation of a big knotty excrescence at the point of grafting. Stock—*Bakan*; Scion—*Neem*.

The fig plant (*Ficus carica*) was grafted on the *Umber* (*Ficus glomerata*) in the rains of 1909. Three successful grafts were obtained and were planted in June 1910. These grew well for

about a year but afterwards failed as the fig began to wither at the resting period of *Umber*.

To cite another instance, *Ipomœa Horsfalliæ* is an ornamental creeper, attractive for its large and rich, glossy, rose-coloured flowers. Each single plant costs Rs. 3 on account of the difficulty of propagation. Attempts were made by Mr. P. G. Joshi, Superintendent, Ganeshkhind Botanical Gardens, to increase the plant by grafting it on *Ipomœa carnea*, a plant commonly found in gardens and easily multiplied by cuttings. One graft made in October 1917 succeeded after two and a half months. The plant grew well for about ten months when it withered as the stock plant was then at its resting time.

If thus the period of activity or the rate of growth of stocks and scions are entirely different, there is a considerable check in the flow of sap with the result that the plants succumb.

INFLUENCE OF SCION ON THE STOCK.

Let us now consider the influence of scion on the stock. As a rule, in all fruit plants the scion has a preponderating influence; and the plant bears the same quality of fruit as the scion. It is generally believed that oranges grafted on *Sakhar-limbu* or orange plants become much more sweet than oranges on *Jamberi* stock, but experience teaches otherwise. In all cases of such grafting the quality of the scion alone predominated. This phenomenon is explained by Sorauer¹ as follows: "The Cambium is a tissue the young cells of which have inherited from their first formation the tendencies of their mother cells and therefore continue to function in the same way, forming the same sort of cell-wall and cell contents as their predecessors did. The characters of the scion as well as those of the stock will develop themselves separately in their several tissues."

The position of the scion, however, does influence the flowering. The following are examples:—In August 1914, in the Ganeshkhind Botanical Gardens, a thirty-year-old Shaha-buddin mango-tree was

¹ "Treatise on the Physiology of Plants," p. 194.

used as stock and five branches from grafted plants in pots were transferred to it by grafting. The scions were grafted on to the end of well-ripened branches. In January 1915, two of the scions bore inflorescences but did not develop fruits.

Also in August 1914, one branch of Borsha, a grafted mango plant in pot, was transferred to a big country plant and this bore two well developed fruits in May 1915.

In both the above cases the pot-plants from which the scions were taken produced no inflorescences, although branches similar to the scions were purposely left to see how they would behave.

In Bassein Garden, a country mango-tree of about 39 years old was heavily cut back on March 6, 1912. Many new shoots sprang up from stumps and on these shoots were grafted scions of Alphonse and Sakharia varieties on May 22, 1912. Grafting was done by enarch from plants in small pots tied near the branches of the stock. Out of 40 scions thus placed, three flowered on January 22, 1914. The first crop of 38 fruits was obtained from this tree in June 1916. The original plants in the pots from which the scions were taken had not flowered by this time. It seems rational to assume that the position at the end of a branch in the system of a big tree is likely to accelerate flowering.

In the above instances, the scions were of mature wood, but if young and immature scions are inserted, one would not naturally expect such early flowering.

In the Ganeshkhind Botanical Gardens, 28 one-year-old mango seedlings were transferred, in August 1914, on to branches of ripened wood that were likely to bear inflorescences in 1915, on country and Shaha-buddin mango-trees; but none of these transferred young seedlings bore any inflorescences, though similar shoots, bearing no grafted seedling branches, had passed three flowering stages. Similarly, on a five-year-old guava plant 24 scions of Sind-Hyderabad variety of four months old were transferred on 19th January, 1919. Twenty-one of these survived but none of these have flowered though the plant passed one flowering stage. From the above it may be seen that mature scions produce flowers early and that immature scions go on making vegetative growths, no matter where they are

situated, and produce flowers when sufficient plastic material has been formed in the shoots. This condition may, to a certain extent, be hastened by the stock of an advanced age. The results are, however, still inconclusive, but the question has an important practical bearing, as, if early flowering is induced on such young transferred branches, considerable saving of time would be assured, and such plants as hybrid and polyembryonic mangoes, seedless guavas, etc., would be forced to reveal their characters at an early date.

INSERTION OF MORE SCIONS THAN ONE.

Very often more scions than one can be inserted on the different branches of the stock. This is done more for curiosity than for any practical utility. In Goa the writer has seen three different scions inserted, *viz.*, Fernadin, Musherad, and Pairi on three branches of a country mango. These were all in fruits. On a top-worked country mango-tree in Bassein garden, the following varieties were harvested from a single plant in June 1916:—

30 Pairi fruits.
 2 Alphonse „
 4 Batlee „
 2 Sakharia „

In the Ganeshkhind Botanical Gardens, on an Edward rose plant the following eleven varieties were budded in January 1913, (1) Madam Furtado, (2) Cook Peach, (3) Devoniensis, (4) La-France, (5) Madam Halphen, (6) Glorie de Dijon, (7) L'Avenir, (8) Nephetos, (9) Belle Lyonnaise, (10) Annie Laxton, and (11) Aimec Vibert. Of these, numbers 10, 3 and 7 grew with more vigour than the rest. Nos. 4, 9, 6, 3 and 5 were in flowers in January 1914, but none of them gave as many blooms as they would otherwise have done. This is as one would naturally expect, as the distribution of sap is not equal in all cases.

It is, however, not desirable to put in more varieties than one on single stock, as the one that is more vigorous draws a larger amount of nourishment from the stock to the detriment of others with the result that they ultimately starve and die.

GRAFTING BETWEEN DIFFERENT GENERA OF THE SAME
NATURAL ORDER.

There is now only one aspect of the question with which I wish to deal, and it is in regard to the influence of stocks and scions of different genera but belonging to the same natural order. Collins¹ says:—"It is said that in Martinique the mango has been successfully grafted on the cashew tree (*Anacardium occidentale*) and it is further stated that seedling mangoes, so grafted, produce fruit double in size, free from fibre, and with the seed so reduced that it is frequently without the power to germinate. The fruit, although melting and very juicy, is said to be without flavour." Collins comments: "These results as reported are so radically opposed to those usually obtained from similar experiments that they are not likely to be generally accepted until verified."

In the Ganeshkhind Botanical Gardens, the following experiments were conducted by the writer:—Grafting of mango scions on stocks of *Semecarpus Anacardium* was done in July 1910 by the crown whip, saddle and tongue grafting methods. The scions remained fresh a little time and then died. Similar graftings were made on *Spondias mangifera* and *Spondias acuminata* but without success. A similar experiment was made in 1914 when 12 mango scions were enarched on to *Semecarpus Anacardium* stocks on August 12 and November 3. Two mango scions were also enarched on to *Hobigarna grahamii* stock but none of these took.

In the Anacardiaceæ, therefore, grafting between different genera has met with failure.

The propagation of *Chiku* (*Achras sapota*) by seeds is a matter of considerable difficulty. The nursery-men, therefore, often employ *Ryan* (*Mimosops hexandra*) seedlings as stocks and graft them with *Chiku* for commercial purposes. Such plants no doubt are vigorous growers, but it has been found by experience in Bassein garden that they do not yield more than 15 fruits per tree though *Chiku* plants grafted on their own stocks yield more than 200 fruits.

¹ "The Mango in Porto-Rico," p. 19. Quoting Jumelli's Cultures Coloniales, p. 201.

CONCLUSIONS.

The following are the conclusions arrived at :—

1. Some stocks have a distinct preference for particular scions while others have no such preference.
2. The stock plays a great part in influencing the habit of growth and hardiness of the scion.
3. The formation of a big knotty excrescence that takes place at the grafted portion in plants, whose rate of growth is not similar, considerably checks the growth of these plants.
4. Plants composed of parts which have different periods of resting fail to grow into big plants when grafted.
5. The scion has a preponderating influence in producing its own quality of fruit.
6. The position of the mature scion at the end of a branch in a big tree does influence the flowering.
7. It is undesirable to insert scions of more than one variety on the branches of a single stock.
8. The grafting between different genera, though taking place in some cases, has not been found successful in the mango.

Selected Articles

THE GROWTH OF THE SUGARCANE.*

BY

C. A. BARBER, C.I.E., Sc.D., F.L.S.

IV.

THE clump or bunch of canes in the field consists of the total output of shoots from one planted set. It is usually made up of several perfectly independent plants, each of which has arisen from a separate bud on the set. The growth of these separate plants, depending on the amount of food and space available, varies a great deal, some being large and dominating the whole clump while others are often small and insignificant, and the canes and shoots belonging to all of them interlace in all directions. We have seen that to make out the branching systems of the distinct plants, a rather tedious process of dissection is necessary, but that, after this has been done, we can construct a formula for each plant. And, when we dissect a number of plants of any one variety, we can obtain an average varietal formula which tends to become simpler and more symmetrical the more dissections are made. We can, in the same way, obtain a formula of each group of cane varieties, and we have seen that these group formulæ show considerable differences from one another, so that the way in which a cane branches becomes an important character in classification.

In our formulæ we have used different letters to indicate branches of different orders. Thus, if we call the main shoot from the original bud on the set a , the branches arising directly from it b , those from b , c , and so on, we can put down the system in algebraical

* Reproduced from the *International Sugar Journal*, February 1920.

form and our plant formula runs somewhat as follows: $a + xb + yc + zd + \dots$. These formulæ for the individual plants are of great service for obtaining the averages of the varieties and ultimately of the groups, but we have found that, for the purpose of visualizing the branching in a plant, we must use another method, that of diagrams. In the 767 plants dissected for this piece of work, we have made a diagram of each as it lay on the table, and in these diagrams it has been possible to include many points for which the formulæ were unsuited. In the diagram the intricate interweaving of the branches is supposed to be unravelled and the whole plant laid out in an orderly manner on the table. Such a diagram is given in Plate XXXII, namely, that of a plant of *Saccharum arundinaceum*, a tall, thick-stemmed, wild cane of India. It will be seen that in this diagram certain conventions have been introduced which will require explanation, and for their elucidation we have selected another diagram, that of a very strongly grown *Yuba* plant (Fig. 1)

Yuba 1916 (7½ months old)

One clump with two plants. Only the larger plant is drawn.

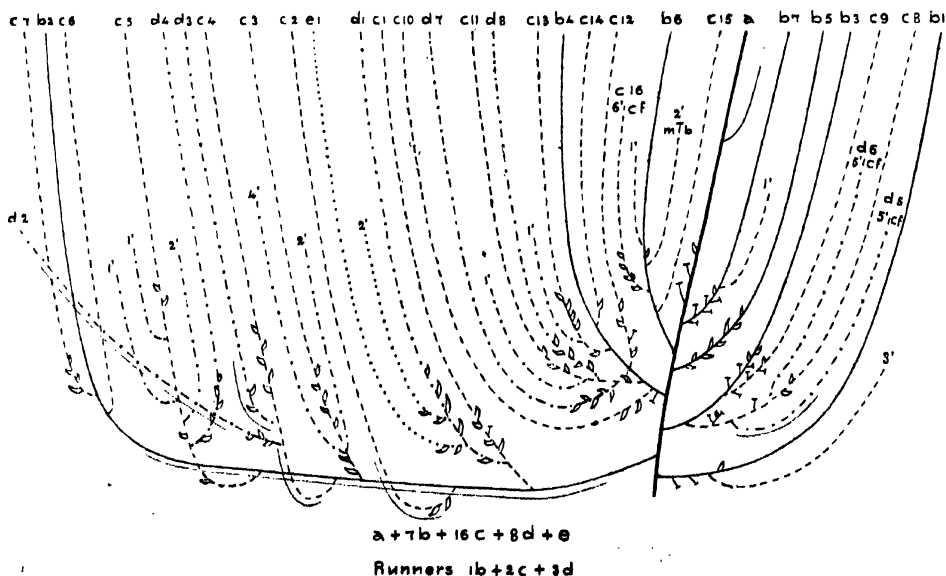
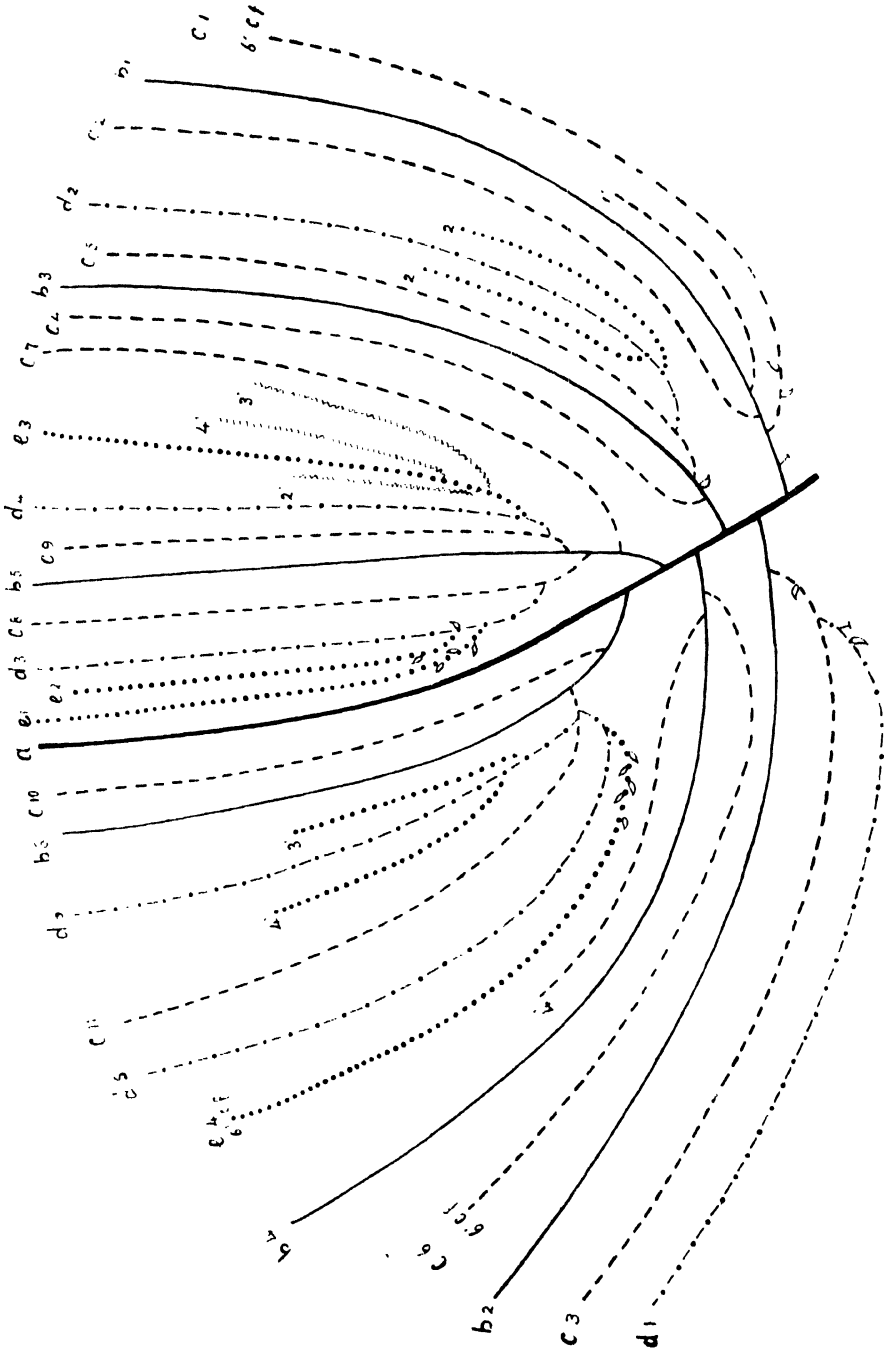

Fig. 1.



AGRA. OF THE BRANCHING SYSTEM IN A PLANT OF SACCHARUM ARUNDINACEUM.

which, it will be remembered, belongs to the Pansahi group of Indian canes. The canes and shoots in this plant were in a veritable tangle, this being caused by the great growth of *b2*, which has developed a number of runners, to be referred to directly. In this diagram the main stem and the branches of different orders are marked by their appropriate letters at their ends, and a different form of line is used for each. The main stem *a* is indicated by a thick line, *bs* by thinner lines, *cs* by lines made up of a series of dashes, *ds* by alternate dots and dashes, *es* by dots, *fs* (Plate XXXII) by zigzags. The formulæ were, from the first, merely intended to give a statement of the canes at harvest, and only those branches in the diagram have letters attached which would, in our opinion, form canes during the season. But, because of the length of time taken in the dissections (that of the *Yuba* shown took some three days, and the work was spread over several months each year), many of them had to be dealt with some time before harvest time. This is shown in the diagram. Those branches already forming full-grown canes are brought up to the upper limit of the figure. Of the immature shoots, those which are cane-forming at their base and would have time to mature by crop time are marked *cf* at their ends, and the length of each immature shoot is given in feet. All resting buds are ignored, as taking no part in the growth of the plant, but such as have begun to grow, either by great swelling or actual bursting, are included in the diagram. Cane varieties differ very much in their development of shoots at the base at reaping time, some having practically none while others have a regular sheaf of them, and this character finds its place in the diagram. As is well known, many deaths occur in the dense mass of the bunch, and these have always received careful attention in the dissections. A dead branch is marked by a short cross line at its end, and a similar convention is applied to dead buds, which are shown as very short lines with a cross line at the end. Lastly, in their struggle to place themselves in a suitable space for unimpeded growth, shoots are capable of altering their position by forming runners underground. These are distinguishable by the intercalation of several long, thin joints between series of very short ones, and occur before the cane

commences to increase in thickness. They are marked in the diagram by thin lines placed under the elongating part. Where the cane is attacked by insects an asterisk is inserted, generally with letters indicating the kind of attack. Thus *m. b.* signifies moth-borer, *w. a.* white ants, and so forth. All of these conventions are illustrated in the *Yuba* diagram, especially a large number of runners. owing to the great effort made by *b2* in its growth.

On the sheet containing the diagram of any plant dissected various memoranda are written down, some of which are mentioned here and others reserved for the next article. In the *Yuba* plant described we have the following :—

Canes formed, $a + 7b + 15c + 6d + e.$

Canes at harvest, $a + 7b + 16c + 8d + e.$

Shoots not cane-forming, $b + 3c + 7d + e.$

Bursting buds, $b + 13c + 48d + 25e + 4f.$

Deaths, $2b + 9c + 7d.$

Runners, $b + 2c + 3d.$

Considering the great irregularity shown by the plant in its growth, it is somewhat remarkable how nearly the canes at harvest come to a perfectly symmetrical formula. The great number of bursting buds shows how healthy the plant is and this is borne out by the very deaths in such a large number of buds and shoots in active growth. There are few shoots not cane-forming, which seems to indicate that the plant is maturing properly.

It was early noted that the members of the Pansahi group of Indian canes were marked by great regularity in their branching systems, and sometimes the way in which the canes grew was distinguished by almost mathematical evenness. Thus many facts of interest in the growth of cane were first noticed in the dissections of members of this group. It would have been impossible to have discovered these facts in the Saretha group, although they were afterwards traced there too, for the Saretha varieties are very irregular and untidy in their habit, crossing and falling about in every direction, showing many deaths and developing many runners. It is somewhat curious that a similar distinction can be drawn between the two cane-forming wild *Saccharums* of India, *S. arundinaceum*

and *S. spontaneum* (the other wild species of this genus do not form solid canes but are seen as great tufts of grass). There are many points of likeness between the formulæ of growth of Pansahi and *S. arundinaceum* and there are also marked resemblances between those of Saretha and *S. spontaneum*, suggesting the possibility of genetic connexion between the two pairs respectively. But although this certainly holds with the Saretha-*S. spontaneum* likenesses, all attempts to find additional morphological connexions between Pansahi and *S. arundinaceum* have failed completely. Enough details have, however, been collected to suggest that the Indian canes, at present classed together with the thick canes of the tropics under the species *S. officinarum*, may have arisen from several distinct wild parents (some of which like *S. spontaneum* are still living, whereas others have not persisted in their wild form), while the thick canes may be the descendants of a different though closely allied form.

We have dealt somewhat fully with the branching system of the members of the Pansahi group of cane because they are of special interest at the present moment. This group includes, as we have seen, the *Yuba* cane of Natal and, according to local descriptions, also the *Agaul* recently imported to Natal from India; *Kavangire* also appears to belong to, and is considered by some as identical with, *Yuba*; perhaps the *Zwinga* and other canes in Brazil may also be included. These are canes inferior in many respects to the thick, juicy, tropical ones, but it is evident that they have their uses, because of their general hardiness in unfavourable conditions, their great tillering power and suitability to the extra-tropical cane-growing regions. It seems likely, from the latest reports, that they will enter more and more into the tropical cane industry, wherever, for some reason or other, thick canes are having a temporary set-back.

In the nature of the case, the thick canes will appear to have received less attention than the groups of Indian canes, but this is because they have been taken together as one group in the dissections. They have by no means been neglected, for as many as 53 plants of various thick canes have been dissected. They present, on the whole,

a much simpler form of branching than the Indian groups, and it would be interesting to determine how far the differences noted in this and the next paper may be traced in different varieties of tropical canes. There is little doubt that such differences exist, but no work has at present been done on them in this direction. In Plate XXXIII, fig. 1, the dissection is shown of the three plants of a rather poorly developed clump of a variety of unknown origin named *Java* in South India. It is in a young stage, but it does not appear likely to produce any more canes at harvest than those shown. In Fig. 2 on the same plate a first ratoon of *Red Mauritius* ready for cutting is shown and in both cases the original set is still attached to the plant, so that the whole system is displayed, including, in the ratoons, the cut ends of the canes reaped in the first year. Text-fig. 2 gives the

Red Mauritius Ratoons

Two ratoon plants at Coimbatore (20 months old)

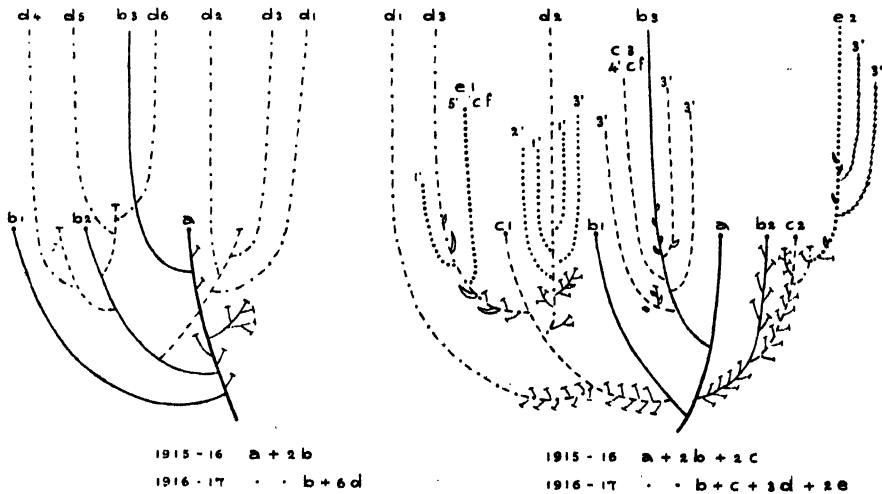

Fig. 2.

diagram of this ratooned plant, the dots at the ends of the branches signifying canes cut at harvest. There were three canes reaped in the first year and seven are ready for reaping in the ratooned plant. There are no shoots forming, nor are any buds bursting;



Fig. 1. Dissection of a "Java" clump of canes, consisting of three plants (5½ months old).



Fig. 2. Dissection of a "Red Mauritius" ratoon (20 months old).

deaths are few, as only 13 can be counted in the two years. The diagram on the right is also one of a ratooned *Red Mauritius* cane, dissected at the same time and place. It is apparently a much more well developed plant. There were five canes in the first year, but the number of canes in the ratoon crop are seven as in the former case. There are 15 bursting buds, 10 young shoots, and as many as 63 deaths. It would be a matter of great interest if the growth of these two canes could be carried one year farther, as it is to my mind doubtful as to which of the two would produce more canes then, because of the great number of deaths in the bigger plant. One is tempted to compare the two with two runners arriving at the same moment at the winning post. One has used up every ounce of his strength while the other has plenty of spare energy which he has not however made the best use of.

Now a good deal of this rather intricate description of this part of the growth of the cane will, at first sight, appear to be rather of academic than practical interest. In the next article we shall study the characters of the canes of different orders of branching, and we shall see that they not only differ in the rapidity with which they grow and mature, but that the joints differ in length and thickness and in the richness of their juice at harvest time. These are all points of great importance in the crop, especially with regard to determining the best time for cutting the canes.

WATER HYACINTH : A MENACE TO NAVIGATION.*

BY

ETHELBERT JOHNSON,

*Technical Assistant, Division of Plant Industry, State Department
of Agriculture, California.*

FLORISTS in southern California offer for sale a beautiful aquatic plant called water hyacinth (*Eichornia crassipes* Solms.). This plant, so highly prized in aquaria, and its near relatives, the pickerel weeds, have come into ill repute among navigators in tropical and subtropical waters, and more especially in the Gulf States, where the enormous sums expended in clearing streams of this pest have earned it the name of "million dollar weed." The history of its establishment is not known, but it was certainly introduced as an ornamental aquatic, and is said to have been planted in a pond near Palatka, Florida, where it soon became so abundant as to necessitate control measures, and it was taken up and thrown into the St. Johns River.

In addition to interfering with navigation the abundance of water hyacinth in the St. Johns River and its tributaries at one time caused an annual loss of about one-fourth the value of the logs rafted down the river from the valuable forests of cypress, pine, and red cedar bordering on that stream. The fishing industry also suffers, because of the difficulty encountered by fishermen in setting their nets. In time of flood, the bridges have sometimes been too low to allow the collected mass of plants to pass under, and the

* Reprinted from the *California Monthly Bulletin*, Vol. IX, No. 3.

pressure has overturned them. Moreover, the rank and decaying vegetation has been declared a menace to health and sanitation, as it not only affords a shelter and breeding place for disease-carrying insects, but interferes with the disposal of sewage.



Fig. 1. Water hyacinth (*Eichornia crassipes* Solms.).

A description of the plant and its habits, with a view to considering the possibility of its becoming established in the navigable streams of California, and a consideration of the methods whereby its control has been attempted, is the object of this paper.

DESCRIPTION.

The plant is a floating perennial, the leaves forming in rosettes usually one to two feet in height from the surface of the water. The leaves are of two kinds: those below the surface of the water

are long and narrow, while those above the water line are usually broad, obovate to nearly circular. The leaf stems are enlarged into oval bulbs filled with aircells, especially in young plants and when the plants are growing in small groups. When the leaves are crowded the bladder-like petioles are not so large.



Fig. 2. An inland creek completely covered with water hyacinth.

The stem which bears the flower is about a foot long, with a single leaf and several wavy-margined sheaths at and above the middle. This stem bears about eight flowers in a loose terminal spike. The flowers are funnel-shaped, pale violet in colour, with six lobes, the upper of which is larger than the others and has on it a large patch of blue with an oblong or pear-shaped spot of bright yellow in the centre. The stamens are all curved toward the tip, three of them long and three short. The seed pod is three-celled, becoming an egg-shaped or elongated capsule with the withered perianth remaining attached.

The plant produces numerous seeds. At maturity, the stem bends so as to immerse the pod. Propagation is also by means of runners which send out roots from the nodes.

The roots are of two kinds: horizontal roots, which are often thick and fleshy and pieces of which will grow readily; and vertical roots with a slender, wirelike stem, often as long as two feet, covered with small fibrous roots which give them a feathery appearance. The roots are exceedingly numerous, forming a dense brushy mass. Where the water is shallow, the roots penetrate the soil and become anchored, but in deeper water they float freely.

The tops are easily killed by frost, for the plant is a native of tropical South America, but the root system is kept alive by its immersion in water. The growth is most vigorous in spring. During

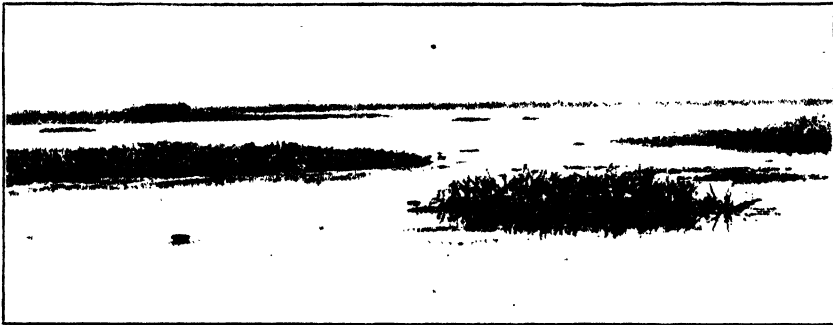

Fig. 3. Floating masses of water hyacinth.

the season of low water the leaves become yellowish and growth appears to be retarded. After the plant has been established in any locality for a number of years, the growth is less vigorous than when young, but after a flood it resumes its vigorous growth in response to the new supply of nutrient material. It is quite sensitive to salt water, but thrives in subsaline or brackish water.

CONTROL.

The water hyacinth is so abundant in Florida, Louisiana, and Texas as to obstruct navigation in the waters emptying into the Gulf of Mexico. Its eradication was entrusted in 1899 to the United States Engineer's Office of the War Department, to which was given "authority to remove the plant by any chemical, mechanical, or other means whatever." From that time the Engineer Office has

worked continuously on eradication, and has spent hundreds of thousands of dollars in attempting to remove it from navigable streams.

No method has ever been found which will completely remove the plant at a reasonable cost, although every known chemical has been experimented with ; but the solution which has been found most effective is an arsenical spray.

The water hyacinth is eaten with relish by stock, and in Florida its use as a feed had become so well established that it was considered necessary, in making an appropriation by the Rivers and Harbours Act of 1905 for the removal of the plant from the St. Johns river and other navigable streams of Florida, to insert a proviso that " no chemical process be used injurious to cattle." It was at first attempted to break up the masses of the plant and push the pieces into the current, but this was found unsatisfactory and exceedingly expensive. Since 1909 an elevator fixed to a barge has been used which gathers the plant in much the same way as kelp is gathered. Fixed booms are maintained across non-navigable streams to prevent the plant floating into navigable streams, and movable and semi-automatic booms to prevent its floating from one navigable stream into another. Labourers and watchmen are employed to detect or prevent the spread of the plant.

In the other Gulf States, the use of chemicals is not prohibited, and although some difficulties are encountered by owners of stock along the streams allowing their animals to eat the sprayed plant, with fatal results, in general local co-operation is obtained in combating the pest.

In Louisiana, two barges, propelled by gasoline launches, and equipped with tanks for mixing and pumps for spraying the chemical solution, are kept continually in service from about April 1 to December 1 of each year. It is necessary also to maintain booms across the stream as in Florida.

To make the solution used in spraying the water hyacinths, 600 pounds of white arsenic and 600 pounds of sal soda are placed in a tank with about 600 gallons of water. The mixture is brought to a boil and kept boiling for two hours. It is then drained

off and diluted with cold water to 9,600 to 12,000 gallons, depending on the strength of solution desired.

For spraying the solution over the hyacinths a duplex Worthington pump $4\frac{1}{2}$ inches by $2\frac{3}{4}$ inches by 4 inches is used, with one-inch six-ply steam hose and a Fuller nozzle which is designed to give a very fine spray. The pressure on the hose is usually 50 pounds. On warm sunny days, one gallon of the diluted solution is ordinarily sufficient to destroy ten square yards of hyacinths. If the day is cloudy or cool, a larger quantity is necessary. Where the hyacinths are very tall, the spray does not reach the shorter plants, and a second application becomes necessary to reach those not killed at first. In the year ending June 30, 1919, the two barges sprayed 1,613,383 square yards of the hyacinth in Louisiana waters, using 201,908 gallons of solution, at a total cost of \$ 13,464.21, or \$ 0.0083 per square yard.

In spite of the enormous quantities of this pest destroyed annually since the work was first undertaken in 1899, it is still necessary to repeat the control measures year after year. So insidious is this floating menace to navigation that wherever the strictest precautions are not observed, a stream or harbour may be over night rendered impassable.

It is hardly likely that this tropical plant could become established naturally in the waters of the Sacramento and San Joaquin rivers in California, but it is extremely probable that if once transplanted here, it would spread rapidly and soon prove as great a menace to navigation as it is in the waters emptying into the Gulf of Mexico.

BRITISH CROP PRODUCTION.*

BY

EDWARD J. RUSSELL, F.R.S.

(Concluded from Vol. XV, Pt. IV, p. 459.)

FODDER and hay crops play a more important part than cereals in the economy of the farm, because they are the raw materials for a highly important part of the farmer's business—the production of meat, milk, or butter. They are too bulky to transport in any quantity and farmers use only as much as they themselves grow. The output of meat and dairy produce is, therefore, limited by the quantities of these crops at the farmer's disposal. The quantities produced just before the war and in 1918 were :—

Production of fodder and hay crops.

	YIELD PER ACRE 1908-17		ACREAGE, MILLIONS OF ACRES				Total produce, millions of tons	
	England and Wales Tons	United Kingdom Tons	England and Wales		United Kingdom		1914	1918
			1914	1918	1914	1918		
	Cwt.	Cwt.						
Swedes ..	13·0	14·6	1·04	0·91	1·75	1·60	24·2	22·8
Mangolds ..	19·5	19·5	0·43	0·41	0·51	0·50	9·5	10·3
Hay (temporary) ..	29·1	32·2	1·55	1·45	2·90	2·80	4·2	4·4
Permanent grass ..	22·6	27·9	4·79	4·30	6·49	5·95	8·2	7·9

* Discourse delivered at the Royal Institution in February 1920. Reprinted from *Nature*, dated 15th April, 1920.

Like cereals and potatoes, these crops are greatly affected by artificial fertilizers, especially by phosphates, which increase not only the yield, but also the feeding value per ton. This is strikingly shown in the case of swedes and turnips, which receive a large part of the superphosphate made in this country. Mangolds respond remarkably well to potassic fertilizers and to salt. There is much to be learned from a systematic study of the influence of artificial manures on the composition and feeding value of these crops under the varied conditions of this country.

A further reason for the important part played by these crops in the economy of the farm is that they profoundly affect the fertility of the soil. They do not remove from the soil all the fertilizing constituents which must be added to secure maximum growth; some of these constituents are left behind in the soil to benefit the next crop— a rare instance of double effectiveness for which the farmer ought to be profoundly thankful. In the second place, even the fertilizing constituents which are absorbed by the crop are not entirely retained by the animal; considerable quantities are excreted and pass into the manure, and again are added to the soil. There is, therefore, the possibility of constant improvement of the soil; larger fodder crops enable more livestock to be kept, more livestock make more manure, and more manure gives still larger crops. It is sometimes argued that meat or milk production is in some way opposed to corn production, but on this method there is no antagonism; on the contrary, each helps the other. The production of more meat is consistent with, and indeed involves, the production of more corn.

The simplest way of utilizing animal excretions without loss is to allow the animals to consume the crop on the land where it grows, and this is frequently done excepting where the soil is so sticky as to become very unpleasant in wet weather. Sheep are the best animals for the purpose, as they are easily penned in by light hurdles, these being moved as each portion of the field is cleared; this folding is a common occurrence on the chalky and sandy soils of the Southern and Eastern Counties.

Bullocks are less tractable, and cannot be enclosed by light hurdles ; they are, therefore, generally kept in yards, roofed in if possible, but oftentimes open. Sufficient straw is added to provide them with bedding and to soak up the excretions. In this way the fertilizing constituents of the straw as well as of the food are returned to the soil.

In the case of dairy cows the treatment is rather different ; they have to be housed properly in quarters which are sometimes palatial, and for hygienic reasons they are allowed but little bedding. Their manure is removed once daily—sometimes oftener—the primary object being to get it away without contaminating the milk. The investigations already referred to for which Lord Elveden provides the funds are now being extended to the dairy farm to see how far it is possible to save the manure without prejudice to the purity of the milk.

In the old days, when farmyard manure was the only manure and the old type of implements alone were available, farmers had to arrange their crops on a definite plan in order to get through their work and maintain permanently the productiveness of the land. There thus grew up a system known as the rotation of crops, which contributed very largely to the agricultural developments of the sixties, and ultimately became a rigid rule of husbandry strictly enforced over large parts of the country. Modern cultivation implements and fertilizers justify much more latitude, however, and no good farmer ought to be restricted in his cropping, provided, of course, that he maintains the fertility of his land. It is sometimes a convenience on the dairy farm to grow the same crop year after year on the same land and the Rothamsted experiments show that this can be done excepting only in the case of clover. With this exception there is no more need to have a rotation of crops than there is to have a rotation of tenants in a house. It is essential, however, that the land should be kept free from other competitors and from disease germs. Freedom from competition means the exclusion of weeds. In the old days this had to be effected by periodical bare fallows. Nowadays a different course is possible ; modern cultivation implements worked by a tractor allow great scope for the

suppression of weeds. There is, however, one crop that must be grown periodically to ensure the best results—clover or a mixture of clover and grass. Clover affords valuable food for cattle during winter, and it also enriches the soil in highly valuable nitrogenous organic matter. Much of this is the work of the plant itself, and could equally well be done by grass; but the enrichment in nitrogen is the work of bacteria residing in the nodules in the clover-roots and is unique among the phenomena of the farm.

Unfortunately, clover, unlike other crops, cannot be grown frequently on the same land, and, consequently, the farmer is unable to make as much use of it as he would like. Investigators have for many years been trying to increase the effectiveness of the clover organism, but without result. Inoculation of the soil with virulent strains has been tried, but it was unsuccessful in this country, although results are claimed in the United States. The problem has recently been taken up at Rothamsted, and one reason found for the previous failure. The organism has several stages in its life-history, one of which is a period of rest; some conditions favour a long rest, others a shorter one, and Mr. H. G. Thornton is endeavouring to find out how to increase the activity of the organism in the soil and ensure that its work shall be done. Attention is being devoted also to the causes of failure of the crop. The clover crop furnishes some of the most important problems in arable farming before us.

In the meantime, a working solution lies in growing an admixture of grasses with the clover. This reduces the risk of failure while considerably benefiting both soil and farmer.

A typical arable district is thus a busy region in which both farmers and workers are kept constantly occupied. The crops claim attention all through the year, and particularly in summer, while in winter the animals need attention. Four or more men can be regularly employed per 100 acres. An organized village life has developed, having distinctive characteristics of its own and presenting endless scope for the intelligent social worker.

Grass farming, on the other hand, stands out in sharp contrast with all this. The grass farmer puts his animals into the fields,

and Nature does the rest; when they are fat he sells them to the butcher. It is essentially summer work; the winters are left free. As no man can long remain idle, there has been an extensive development of hunting and its attendant occupation, horse-breeding, in the English grass regions. While the grass farmer's life is not all idyllic joy, it is, at any rate, free from much of the worry and uncertainty of arable farming, and it brings in sufficient money to ensure a modest competence. One can quite understand the reluctance of the farmer to quit this path of safety.

If one could accept the doctrine that a man could do what he liked with his land, the grass farmer could be left alone and reckoned among Virgil's too happy husbandmen. But this doctrine is now somewhat out of court, and the needs of the community have also to be taken into account. From this point of view grass husbandry, in spite of its safeness for the individual farmer, is not so good for the community as arable farming, since it is less productive per acre of ground. This was realized before the war, and was vividly brought to the notice of farmers by Sir Thomas Middleton, who drew up the following table:—

Number of persons who could be supplied with energy for one year from the products of 100 acres of

Poor pasture converted into meat	2-4
Medium pasture ditto	12-14
Rich pasture ditto	25-50
Arable land producing corn and meat	100-110

The area of rich pasture is very restricted. An improvement can often be made in poor and medium pasture by the use of basic slag, by drainage, and in other ways, but the results could probably never surpass those now obtained on rich pasture. None of them approach the results obtained on arable land.

During the war, therefore, the policy of the Food Production Department was to convert grassland into arable, and much was done; but now that the element of compulsion has disappeared some of the arable has gone back to grass. It is not that the farmer is trying to avoid work; he is impressed by the greater risk of arable

farming,* and, above all, he desires to keep to the well-established principle that his system of husbandry must suit the local conditions. This is strikingly shown by the following returns from a large number of farms :—

Collected by the Agricultural Costings Committee.

	Income per acre			Expenditure per acre			Profit† per acre			Capital per acre		
	£	s.	d.	£	s.	d.	£	s.	d.	£	s.	d.
ENGLAND AND WALES—												
Mixed farms ..	9	12	5	10	2	11	1	7	2	13	9	0
Dairy farms ..	14	17	6	13	18	5	1	7	4	15	7	0
Corn and sheep ..	7	7	1	7	4	10	1	14	2	12	16	9
Large sheep farm ..	1	4	3	0	17	6	0	8	5	1	7	10
All-Scottish ..	5	10	9	4	15	10	1	4	11	7	7	9

The profit per acre from the large sheep farm is small in itself, but it is large in proportion to the capital and the expenditure, and, given a sufficient acreage, the farm is more lucrative than the more risky mixed or dairy farms. The risk of corn production can, and probably will, have to be met by some system of insurance or guarantee, but the need to conform to local conditions will always remain.

The problem therefore arises: Can a system of husbandry be devised which suits the natural conditions as well as grass, and is as productive of total wealth as arable crops? I believe this can be done. Grass is not the only crop adapted to moist conditions or

* On our ordinary farm at Rothamsted (distinct from the experimental land) the expenditure on arable land is continuously increasing, while that on the grassland is much less. The figures are :—

	1913-14	1917-18	1918-19
	£ s.	£ s.	£ s.
Wheat ..	5 7	10 14	14 0
Oats ..	6 4	9 7	14 5
Roots ..	17 10	20 18	36 0
Potatoes ..	21 1	37 11	46 0
Grass (hay) ..	3 12	4 16	6 0
.. (grazing) ..	2 15	2 4	3 0

Direct wage payments account for about 40 per cent. of the expenditure on arable land, but for less than 15 per cent. of that on grassland.

† Including change in valuation.

heavy soils, and appropriate for the production of meat and milk. Many other leaf or root crops serve as well, some of which yield much more food per acre than does grass. Vetches, rape, mangolds, kale, and marrow-stem kale can all be used direct, and there are various mixtures of oats with peas, tares, vetches, etc., that can be fed green and made into hay or silage as the farmer may wish. The use of these crops in the place of grass for the feeding of livestock is known as the soiling system.

We are only just beginning to discover the combinations of crops best suited to particular conditions. An interesting experiment is in progress at the Harper Adams Agricultural College, which, however, should be repeated elsewhere. Each crop is governed by the same general laws as hold for cereals. In each case the yield and feeding value can both be increased by the proper use of artificial fertilizers, and there is the further possibility of great improvement by the plant-breeder.

It is in this direction that I think British agriculture will develop in the future. The system is strictly in accordance with the laws of science, and therefore it needs a minimum amount of artificial support. It gives the farmer abundant scope for the production of livestock, which he has always regarded as his sheet-anchor, and the community an abundant production of food per acre. Most important of all, while retaining the best features of our present arable and grass systems, it allows of considerable further development.

I shall not venture any opinion as to how far we could go in feeding ourselves. The accompanying table shows what we did before the war, and what, on our present technical knowledge, we could do now, assuming that the insurance problem of covering the extra risks of arable farming were solved, and assuming also a reasonable increase in the efficiency of labour.

In this country we can certainly hope to find the solution of the insurance problem, and I hope and believe of the labour problem also. Our output per acre of the arable crops is distinctly above that of many other countries, though we no longer lead as we did in the sixties. Our output per man, however, is not particularly good, and is open to considerable improvement. Those who know the

agricultural labourer best have the fullest faith that his sterling qualities will enable him to rise to the new levels of industrial capacity which the man of science and the engineer have opened out for British agriculture. There are anxious days ahead, but with wise and sympathetic treatment the difficulties can be solved and our future assured.

*Consumption and production of human food in the United Kingdom.
Million tons per annum.*

	Consumption (1909-13)	HOME PRODUCTION		
		Pre-war	1919*	Estimated attainable
Wheat, barley and oats ..	13.4	6.5	7.0	10.0
Other cereals	3.5
Potatoes	5.5	4.8	6.3	7.0
Dairy produce	5.2	4.7	..	5.0
Meat	3.0	1.8	..	2.5

* Mr. McCurdy gives the following details for 1919 (see *Times*, February 18, 1920) :—

Consumption and production of food in the United Kingdom, 1919.

Commodity	Estimated total consumption	PROPORTION OF HOME-GROWN AND IMPORTED PRODUCE INCLUDED	
		Home-grown	Imported
		Tons	Per cent.
Wheat	7,395,000	27	73
Barley	1,956,000	64	36
Oats	2,297,000	92	8
Beef and veal	995,000	66	34
Mutton and lamb	368,000	57	43
Bacon and hams	447,000	19	81
Butter	180,000	58	42
Cheese	145,000	30	70

Notes. Cereals : The quantities are given after deduction for seed, and in the cases of wheat for tailings also. Bacon : The quantities given are for bacon as smoked or dried.

THE ORIGIN OF THE SUGARCANE.*

TRACING the passage of any cultivated plant from its wild conditions is always a fascinating amusement. Language, history, botany, all three lines have to be carefully followed out, and it is only by the convergence of the three that any certainty can be attained, especially when the cultivated form is no longer directly traceable to any wild ancestor. In the case of the sugarcane, all three of these lines are available in south-eastern Asia, and the result arrived at is that the sugarcane is thought to have arisen from a wild grass, widely spread over India and the parts of Asia east of it and extending over some of the islands of the Pacific. The presence of a very ancient language and literature in India has perhaps somewhat obscured the claims of oceanic islands which have none of these advantages. As to whether the Pacific Islands have a right to be considered as a home of the original plant from which the cultivated sugarcane has arisen, this must be left to the last named line of study, namely, that of botany.

Saccharum spontaneum is the only wild species in the genus which has close botanical relations with the sugarcane, which is named botanically *Saccharum officinarum*. It is found in every part of India and shows itself remarkably sensitive in its varieties to the moisture of the locality. Thus in the Punjab it is a small wiry grass which causes considerable trouble in the fields; this form extends as far as the Central Provinces, but further south it is confined to wet places, ditches and river banks, and shows no inclination to become thicker and more cane-like in the tropical conditions of the Madras Presidency. In Bengal, Assam, and Burma, however,

* Reprinted from the *International Sugar Journal*, May 1920.

where the air is moister, a number of thicker forms are found with broader leaves, some of which, such as that met with in the ponds around Dacca, show a close approximation to the more primitive groups of indigenous Indian canes. The botanical evidence, therefore, suggests that the transition from the wild to the cultivated form may be most reasonably sought less in the tropical parts of India than around the north of the Bay of Bengal, and this is the view usually held. Even in the Punjab, where the wild cane is a field weed, the cultivator points to it as the ancestor of the sugarcane, and there is some evidence that in former times the thicker Bengal form was occasionally crushed, on the banks of the Hooghly, for its half-sweet juice.

But the fact must not be lost sight of that there are a number of distinct groups among Indian sugarcanes, and it is only in the primitive Saretha series that this line of derivation is clearly seen. Many of the members of this group show marked resemblances to the wild *Saccharum spontaneum*. The varieties differ a great deal among themselves and, starting with primitive forms in the Punjab, extend east and south ever increasing in size as they approach more congenial conditions of climate. The Sunnabile group, with a similar distribution, show some evidence of being derived from the same source, in that its most primitive forms in the Punjab are with some difficulty distinguished from the smaller Saretha varieties. But the connexion between these two groups and the Mungo, Nargori, and Pansahi are obscure, and if they are to be traced also to *Saccharum spontaneum* one can only suggest that, at some former time, the whole species passed through a mutational period whereby a series of new forms were developed which have served as the starting points for these three groups. They are among themselves much more homogeneous, and as distinguished from the Saretha and Sunnabile give rather the impression of being merely cane varieties which have undergone slight modifications through being long grown under special climatic conditions. They would thus appear to be of later origin and are, as might be expected, much more restricted in their geographical range. The same line of development might be suggested lastly for the thick cane group, if we are to regard

them also as having arisen in India from a wild ancestor. But it occurs to the writer that, in considering their characters, we may have to look to another place for the origin of the tropical forms. The common origin of the whole of the cultivated sugarcanes was assumed at a time when no careful morphological studies had been made of them. During the past eight or nine years this part of our knowledge of the sugarcane has made great strides, and various systems of natural classification have been worked out, founded on variations in the character of the different vegetative organs of the plant. A serious attempt has, at the same time, been made to form a continuous series, commencing with the wild *Saccharum spontaneum*, passing through the indigenous Indian canes, and culminating in the thick tropical varieties which form the main sources of our commercial sugar in the tropics.

In many sugar-growing countries, where the conditions have proved adverse to these comparatively delicate thicker canes, members of the Indian groups have effected a footing. The most important, from our point of view, of these introductions has been that into South America, for it appears to have occurred so long ago that no one can say exactly when it took place; and it has only been by the exact study of the Indian groups that the source of the immigrant has been definitely settled. This throws some light upon the theory, somewhat loosely held, that the thicker tropical forms have been derived from the more primitive Indian forms by long acclimatization in warmer, moister regions. Influenced by this belief, a series of the North Indian forms were brought down to Madras some eight or nine years ago, and grown continuously under the same conditions as the tropical canes usually planted there. It was desired to see if any change in the direction of thick cane characters would take place. The period is of course far too short for any reliable opinion to be formed, but it may be recorded that there appears to be no trace of any change. The discovery that the South American thin canes were of the Pansahi group, still retaining all the peculiar morphological characters of that class, was at once recognized as of importance in the enquiry; and it was this that first suggested to the writer that the gulf between the Indian canes and

those of the tropics was insuperable within the limits of agricultural time. The idea of a separate origin of the thick cane group has recently been strengthened by an appreciation of the fact that, at one time and another, the finest of the tropical canes have been received from among the islands of the Pacific, where no careful agricultural selection was likely to occur. The supposed origin of the Bourbon cane from Malabar need not be taken very seriously, for anyone acquainted with the character of the canes growing there will find it difficult to believe that such a form could have been otherwise than a temporary introduction by the Portuguese, if ever it got there. Quite recently a magnificent series of new canes, fully equal to any that have brought wealth in the past to the cane-growing countries of the tropics, have been discovered in the unexplored recesses of New Guinea, a place sufficiently remote to make it practically impossible that these could have been derived from India. We are driven then to conclude that the thick cane group, essentially different in so many respects from the indigenous Indian ones, has arisen from a separate centre, namely, the mountainous islands of the Malay Archipelago and Polynesia. It is interesting to note that *Saccharum spontaneum* is recorded as indigenous in many of these islands as well as in India, so that we have still the possibility of this species being the ancestor of the thick canes. But it seems to the writer probable that, in the absence of connecting links, it is more reasonable to assume that the thick canes as a group arose rather from an allied species now lost in the wild state. This separate origin would do away with the anomaly that, while in the Indian series the capacity of producing fertile flowers and seedlings steadily diminishes with distance from the wild form, it returns in full force with the thick canes, which in any connected series from a common origin would presumably be the most highly developed of the cultivated varieties and groups. [C. A. B.]

Notes

THE GINNING PERCENTAGE OF COTTON IN ITS RELATION TO THE SEASON.

DURING the past four years the Padu Experimental Station (Sagaing District, Burma) has experienced one exceptionally unfavourable season for upland cultivation, and in that season the ginning percentages as well as the yields of all the cottons under cultivation uniformly dropped. The writer has nowhere seen it recorded that the character of the season has such a marked influence upon the proportion of lint to seed and he is seeking to know whether this has been the experience of others.

In the accompanying table it will be seen that, whilst the relative ginning percentage of the different strains remains nearly the same, they have each dropped roughly about 3 per cent. during the year 1918-19. In the following normal season those of which the cultivation has been continued have returned to their normal ginning percentages of the previous years.

NOTES

Ginning percentages of cotton in relation to season.

Year	Climatic conditions (especially as regards rainfall)	GINNING PERCENTAGES OF COTTON										Local mixture
		Selection No. 2001	Selection No. 2002	Selection No. 2005	Selection No. 2006	Selection No. 2103	Selection No. 2106	Selection No. 2107	Selection No. 2108			
1916-17 ..	Rainfall heavy (38.58 inches), favourable to upland culti- vation ..	33.53	34.11	33.94	32.00	32.87	35.75	36.21	34.48	30.98		
1917-18 ..	Rainfall very good (33.69 inches), season very favour- able to upland cultivation ..	33.49	33.89	33.86	34.21	30.33	36.79	38.58	35.29	32.45		
1918-19 ..	Rainfall poorest on record (20.10 inches) and badly dis- tributed, very unfavourable season for upland cultivation	(a) 30.38 (b) 30.47 av. 30.42	(a) 30.78 (b) 30.85 av. 30.81	(a) 30.68 (b) 31.31 av. 30.99	(a) 29.27 (b) 29.89 av. 29.58	(a) 30.00 (b) 30.49 av. 30.24	(a) 31.25 (b) 32.30 av. 31.77	(a) 32.17 (b) 33.79 av. 32.98	(a) 33.86 (b) 33.11 av. 33.48	28.91		
1919-20 ..	Rainfall good (29.92 inches), favourable to upland cultiva- tion	av. 34.25	(a) 34.28 (b) 34.01 (c) 34.41 av. 34.25	(a) 33.33 (b) 33.36 (c) 33.34 av. 33.41	(a) 36.54 (b) 36.88 (c) 36.59 av. 36.66	(a) 35.29 (b) 35.33 (c) 36.36 av. 35.67	32.67		

The Padu Experimental Station is situated in a dry tract growing principally wheat, gram, cotton and sesamum—the two last being cultivated almost entirely on the coarse, red, sandy soils of the uplands only. The rainfall is a capricious one, and if it be the case that the season has so marked an effect the ginning percentage of cotton from this region will be very difficult to maintain from year to year. [E. THOMPSTONE.]

* * *

AGRICULTURAL EDUCATION IN MADRAS.

THE question of attracting a better class of students to the Agricultural College at Coimbatore has for some time past been under consideration of the Government of Madras. The present courses at the college were introduced in 1914 when the old three years' course was replaced by one extending to three years and a half. The first two years of the course formed in itself a separate (certificate) course mainly devoted to agriculture, while the remaining one and a half years' course, devoted to sciences allied to agriculture, formed a continuation of the first and qualified for a diploma. The working of this course and the standard attained by students admitted under it have, however, been the subject of some discussion, and the Local Government have now decided that the certificate and the diploma courses should be separated from the beginning; and that, while the qualification for admission to the certificate course should ordinarily be a Secondary School-Leaving Certificate, that of the diploma course should be the Intermediate Examination of the University with Physics, Chemistry or a Biological Science. The Local Government have further authorized the Director of Agriculture to award annually scholarships of the value of Rs. 25 each per mensem to students not exceeding twenty in number. It has also been decided that tuition and lodging will, as heretofore, continue to be provided free of charge. [EDITOR.]

* * *

SEED ELECTRIFICATION.

MESSRS. SUTTON AND SONS, Reading, have published an interesting contribution to the literature on seed electrification. This

bulletin (No. 11) presents the results of a number of germination and field tests carried out in 1919 with seeds of carrot, swede, cabbage, and mangold. The best-known process of seed electrification, *viz.*, the Wolfryn process, consists in immersing the seeds in a solution either of common salt and water or of calcium chloride and water, through which an electric current is then passed. After this treatment the seeds are dried at a temperature of 100°F., and they are then ready for sowing. Obviously two processes are here involved, seed immersion and seed electrification, and the Reading experiments were designed primarily to test the value of the Wolfryn process, and secondarily, if there are advantages, to decide whether they are due to the immersion, to the electrification, or to both agents combined. Tests were made with untreated seeds, with seeds electrified by the Wolfryn process, with seeds soaked in a solution of sulphate of ammonia, and with seeds soaked in a solution of salt and water, the strength of the solution being the same as that used in the Wolfryn process. After immersion the seeds were dried at 100°F. and then sown. Regarding the tests as a whole, they do not reveal any advantage from seed electrification, the only possible exception occurring in the case of mangolds, where the germination of the electrified seed was 94 per cent. compared with 82 per cent. for the untreated seed and 86 per cent. for the seed soaked in the salt solution, while in the field tests the electrified mangold seed yielded 62 lb. per pole more than the untreated seed. In all other cases either the electrified seed gave a lower yield than the seeds treated in other ways, or the increase following electrification was so small as to be negligible. [*Nature*, May 13, 1920.]

* * *

LOW-GRADE SUGARCANE MOLASSES (BLACKSTRAP).

THERE is, perhaps, no stock-feeding material that has aroused so much general interest among stockowners and feeders in this country (Louisiana) as low-grade sugarcane molasses, or "blackstrap." . . .

The term "blackstrap" is given to the low-grade uncrystallizable residue of the sugar-making, or sugar-refining, process, which at one time, in Louisiana at least, was discarded as of no economic

value and, consequently, wasted, so far as its feeding importance was concerned.

The use of molasses as an appetizer and tonic for stock has been in vogue with owners and feeders for quite a length of time, however ; but as a food nutrient of the carbohydrate class, its extensive and intelligent adoption dates back only to more recent years, and it is being utilized now, not only as a regular ingredient of mixed rations on plantations and farms, but by the commercial world in the various so-called "sweet feeds" that are to be found upon the market.

It should be understood, however, that while blackstrap is a most valuable food of its class it is not a perfectly-balanced food in itself, as it supplies, in the main, only one of the nutritive elements (carbohydrates) of a mixed and balanced ration.

It is valuable for at least four very good reasons, *viz.*, (1) its palatability ; (2) under normal conditions, its cheapness as a source of the carbohydrate element-sugar ; (3) its high carbohydrate content approximating 53 per cent. ; and (4) the almost complete digestibility of its contained carbohydrates.

It is the writer's opinion that the marked success which has attended its adoption during the past number of years is almost wholly due to its palatability ; its condimental effect in promoting more perfect digestion of other feeds fed with it ; and the readiness with which it can be absorbed into the blood system of the animal for purposes of nutrition.

The earlier analysis of blackstrap showed a somewhat higher percentage of carbohydrates—sugar ; but owing to the increased efficiency in the process of producing sugar to-day, the percentage of its carbohydrates has been reduced to some extent.

The following may be taken as an average of its composition at the present time :

Dry matter	Water	Ash	Carbohydrates
%	%	%	%
77.75	22.25	8.13	53.58

Some years ago the writer addressed a questionnaire to some forty-seven large sugar-plantation-owners in Louisiana to try to

obtain some more or less definite information regarding results they might have had after utilizing their blackstrap in the feeding of their work mules, the number of which approximated 4,500 head. In the replies received, practically everyone conceded to a considerable saving in the amount of his feed bills ranging from ten to fifty per cent. or more ; and all seemed to refer to the marked diminution in the number of cases of dietetic troubles, such as colic, etc. ; and that the health, and, therefore, the capacity of the animals for work, was very much improved.

One could scarcely wish for a higher endorsement of any food product, in the case of horses and mules at least.

The feeding of molasses is not now confined to horses and mules, however ; it is being used with equal success in the feed-lot ; in the dairy ; in the hog-pen, etc.

From inquiries received, it would seem that some feeders not hitherto accustomed to the use of molasses do not appear to quite understand how it should be used to the best advantage

Here it may be stated that its economic use would depend upon the availability and cost of other carbohydrate concentrates.

For example, if corn should be expensive, and molasses considerably cheaper, it would reduce the cost of the ration if part of the corn should be replaced by its equivalent weight of molasses, as the sugar in the latter, while not quite equal to in amount, approximates the starch in the corn, both of which have the same chemical composition. However, we do not deem it altogether advisable to make a complete substitution ; but a partial substitution will frequently economize in the use of corn under high-priced conditions.

Again, it is better to feed molasses where the other ingredients of the ration are in a crushed or mealy condition so as to insure better mastication, or chewing of the whole. When fed with whole grains alone, such as oats or corn, there is a tendency or liability on the part of the animals, especially horses or mules, to "bolt" their food without the necessary chewing of the grains.

For different classes of animals, we submit the following **example.**

For horses or mules weighing 1,000 lb. doing hard work and per day :

Lb.

- 2 Cottonseed meal,
- 6 Cracked corn or chops,
- 6 or 7 Blackstrap,
- 12 Peavine, alfalfa, lespedeza, or any of the good leguminous hays.

[W. H. DALRYMPLE in the *Louisiana Planter and Sugar Manufacturer*, Vol. LXIV, No. 20.]

* * *

A NOTE ON SOME PRELIMINARY EXPERIMENTS FOR STUDYING CROP IRRIGATION.

THE usual bed method of irrigating garden crops in the Bombay Presidency, even when small ridges are made and the water is impounded, is open to many criticisms, chief of which is that it causes the formation of a crust, when the water sinks into the soil, from which evaporation goes on at a rapid rate. Moreover, while the water is standing over the soil, the circulation of the air in the soil is checked if not altogether stopped.

When water remains impounded for some time, as is often the case in sugarcane cultivation, thus stopping the circulation of air, the oxygen for the growth of the roots and the soil organisms become deficient and their activities stop or proceed at a very low rate. If anaerobic conditions continue those organisms which are injurious may become established. Denitrification of the manurial substance may occur or pathological changes in the plants, due to such organisms as sugarcane red rot (*Colletotrichum falcatum*) and ginger soft rot (*Pythium gracile*), may result.

Continued wetting of the soil in bed irrigation has a puddling effect, as the fine particles of the soil are washed downward and become packed into the interstices so that capillary movement and even percolation become reduced, often to such an extent as to make the soil unsuitable as the home of plant roots and of those

beneficial nitrifying bacteria which effect the transformation of manurial matter into plant food.

When small beds are made, the useful operations of after-tillage so necessary to keep the soil in a healthy condition are hindered as all that can be done must be accomplished by inefficient and expensive hand-work.

The curtailment of intertillage necessitated by the small bed system allows the soil puddling and evaporation to go on unhindered.

The ideal soil condition requires that the finer particles must be united into granules to form a crumb-like structure over the particles of which a film of capillary moisture will freely move in all directions and through the interstices between the granules the soil air will circulate freely as it is acted upon by the wind at the surface and the changes of temperature. Under such conditions the roots and the beneficial soil organisms make their maximum growth, while morbid and denitrifying organisms are destroyed or held in check.

How can irrigation be applied so as to enable us to maintain the soil in this condition as near as possible and at the same time avoid as much loss by percolation below the reach of plants and through surface evaporation is the problem.

This condition of the soil can only be obtained by suitable and thorough cultivation together with the application of abundant supplies of organic matter, and is maintained by timely after-tillage operations and the application of irrigation water by such methods as will have the least possible tendency to destroy the condition of the soils described above.

The actual method of achieving this desirable result has been the subject of considerable experiment at Manjri and Poona College stations.

It is plain that it is easier to protect as far as possible the area from becoming injured through standing water than to restore its physical condition, or in other words we should aim at wetting the least possible amount of the soil surface. This means that wide strips of soil on which water has not been impounded should

alternate with the narrowest possible furrows which receive water and a high degree of tilth be maintained on the dry surface soil which would act as a mulch to prevent evaporation. The granulated soil below this mulch having a highly developed capacity for capillary movement will speedily draw the moisture from the wet furrows.

The plant roots should develop in this sub-surface layer of capillary-fed soil below the dry mulch.

A certain amount of time is required for water to spread by capillary movement from the furrow throughout the strips, which may be called growth strips of the field, and water should be kept in the furrows sufficiently long to enable it to thoroughly permeate the growth strip. The time for this process will vary according to the nature of the soil and the width of the strip. The water in the furrow may be maintained for the necessary length of time by two ways. First by impounding a large furrow full. This necessitates level furrows and is accompanied with considerable loss by downward percolation if the soil is at all pervious; moreover it wets a wider strip than necessary, thus producing the injurious action of stagnant water over the part wetted, which must be overcome by later operations, else there will be a loss in the total production of the field as well as a loss of water. The other method which seems to me to be the only rational system for irrigation practical in this part of India is to allow a very small stream to trickle down each furrow.

Experiments have been made at Manjri with the rates of current required to wet a five feet growth strip, and it has been found that a rate of one hundred feet per thirty or forty minutes when the land does not slope over one inch in three hundred feet gives the best results. The rate at which the water should be allowed to move down the furrow depends upon the following conditions :—

1. The capillarity of the soil which depends upon the natural texture, its composition and the state of granulation brought about by the tillage and manure.
2. The width of the growth strip.

3. The length between cross distributing furrows.
4. The slope of the furrow.
5. The depth of soil which is in a condition to hold capillary water and which the plant roots can reach.
6. The amount of water that is necessary to keep the growing strip in the optimum moisture content (*wafsa*).

The width which should be assigned to the growing zone depends upon the conditions named above in one, five and six.

Having determined the rate at which the water should flow either by actual experiment or experience, it is maintained by regulating the size of the stream with the head available.

For regulation I have found tile dams for each furrow to be the simplest and cheapest. These can be made with different sizes of openings and the stream can be varied by sloping the dams, thus increasing the head at their discharge. Work is going on to determine the rate of flow for different types of soil and crops.

The lower ten feet will usually get sufficient water if the holes in the tiles are plugged with mud when the water reaches within ten feet of the end. In order that the work may be completed as expeditiously as by the bed system a large number of furrows must be receiving water at the same time.

I feel that if this system of watering could be generally introduced the water duty of our canals and wells could be increased to an almost incredible extent and waterlogging or salt land trouble become unknown. [J. B. KNIGHT in the *Poona Agric. College Magazine*, Vol. XI, No. 4.]

PERSONAL NOTES, APPOINTMENTS AND TRANSFERS, MEETINGS AND CONFERENCES, ETC.

WE deeply regret to record the death of Mr. F. M. Howlett, B.A., F.E.S., Imperial Pathological Entomologist, which sad event took place at Mussoorie in the morning of Friday, the 20th August, 1920, after a serious operation. We offer our heartfelt condolences to his mother in her bereavement.

THE HON'BLE RAO BAHADUR B. NARASIMHESWARA SARMA GARU has been appointed an Ordinary Member of the Council of the Governor-General of India, in charge of the Department of Revenue and Agriculture.

* * *

MR. J. HULLAH, I.C.S., is confirmed in the appointment of Secretary to the Government of India, Department of Revenue and Agriculture, with effect from the 27th June, 1920.

* * *

MR. S. MILLIGAN, M.A., B.Sc., Director of Agriculture, Bengal, has been appointed Agricultural Adviser to the Government of India, and Director, Agricultural Research Institute, Pusa, with effect from the 18th June, 1920.

* * *

THE names of the following officers have been added to those brought to the notice of the Secretary of State for War for valuable services rendered in India in connection with the war :—

COLONEL G. H. EVANS, C.I.E., C.B.E., A.D.C., Indian Army
(Superintendent, Civil Veterinary Department, Burma).

LIEUTENANT (TEMPORARY MAJOR) K. HEWLETT, O.B.E.,
 Indian Defence Force, Veterinary Corps (Principal,
 Bombay Veterinary College).

* * *

WE congratulate Dr. C. A. Barber, C.I.E., late Sugarcane
 Expert to the Government of Madras, on his appointment by the
 Board of Agricultural Studies, Cambridge University, as a Lecturer
 in Tropical Agriculture for a period of five years.

* * *

DR. E. J. BUTLER., M.B., F.L.S., Imperial Mycologist and Joint
 Director of the Agricultural Research Institute, Pusa, has been
 granted privilege leave for two months, with effect from the 22nd
 July, 1920.

* * *

MR. G. S. HENDERSON, N.D.A., N.D.D., Imperial Agriculturist,
 is appointed to officiate as Joint Director of the Agricultural Research
 Institute, Pusa, *vice* Dr. E. J. Butler on leave.

* * *

MR. W. McRAE, M.A., B.Sc., F.L.S., Government Mycologist,
 Madras, has been appointed to officiate as Imperial Mycologist,
 Pusa, *vice* Dr. E. J. Butler on leave.

* * *

MR. G. EVANS, C.I.E., M.A., Deputy Director of Agriculture,
 Central Provinces, whose services have been placed at the disposal
 of the Government of Bengal, has been appointed Director of
 Agriculture, Bengal, *vice* Mr. S. Milligan.

* * *

DR. R. V. NORRIS, Government Agricultural Chemist, Madras,
 has been appointed to act as Principal, Agricultural College, Coim-
 batore, during the absence of Mr. W. McRae on other duty

* * *

MR. G. R. HILSON, B.Sc., Deputy Director of Agriculture,
 II and III Circles, Madras, has been appointed Government
 Economic Botanist, Madras, for work on cotton, with head-
 quarters at Coimbatore, with effect from the date of his return
 from leave.

MR. F. WARE, M.R.C.V.S., Superintendent, Civil Veterinary Department, Madras, has been granted combined leave for eight months.

* * *

MR. S. SUNDARARAMAN, M.A., has been appointed to act as Government Mycologist, Madras, *vice* Mr. W. McRae on other duty.

* * *

MR. E. BALLARD, B.A., F.E.S., Government Entomologist, Madras, has been granted privilege leave for one month, Mr. T. V. Ramakrishna Ayyar, B.A., F.E.S., F.Z.S., officiating.

* * *

MR. F. T. T. NEWLAND, Government Agricultural Engineer, Madras, has been granted privilege leave for two months, Mr. V. Rangachar Avargal officiating.

* * *

THE HON'BLE MR. H. M. LEAKE, M.A., F.L.S., Officiating Director of Agriculture, United Provinces, has been confirmed in that appointment with effect from the 26th May, 1920.

* * *

MR. G. CLARKE, F.I.C., Offg. Principal, Agricultural College, Cawnpore, has been confirmed in that appointment.

* * *

MR. W. YOUNGMAN, B.Sc., Offg. Economic Botanist to Government, United Provinces, has been confirmed in that appointment.

* * *

BABU RAM PRASAD, Assistant to the Economic Botanist, has been appointed to officiate as Assistant Economic Botanist to Government, United Provinces.

* * *

MAJOR E. W. OLIVER, M.R.C.V.S., F.Z.S., Superintendent, Civil Veterinary Department, United Provinces, has been granted combined leave for seven months and seven days.

CAPTAIN S. G. M. HICKEY, M.R.C.V.S., Second Superintendent, Civil Veterinary Department, United Provinces, will hold charge of Major Oliver's office, in addition to his own duties, during the latter officer's absence.

* * *

MR. D. MILNE, B.Sc., Economic Botanist to Government, Punjab, has been granted combined leave for eight months. Lala Jai Chand, M.Sc., officiates.

* * *

MR. T. A. MILLER BROWNLIE, C.E., M.I.W.E., M.I.M., I.C.E., Agricultural Engineer, Punjab, has been granted combined leave for eight months. Mr. P. A. MacCormack, retired Executive Engineer, P. W. D., officiates.

* * *

MR. F. J. WARTH, M.Sc., Agricultural Chemist, Burma, took over charge of the duties of Deputy Director of Agriculture, Southern Circle, Burma, in addition to his own duties, on the 11th June, 1920.

* * *

THE Secretary of State for India has granted to Mr. T. Rennie, M.R.C.V.S., Second Superintendent, Civil Veterinary Department, Burma, an extension of furlough for 15 days.

* * *

ON return from the combined leave granted to him, Mr. J. H. Ritchie, M.A., Deputy Director of Agriculture, is posted to the Northern Circle, Central Provinces.

* * *

MR. C. P. MAYA DAS, M.A., B.Sc., Officiating Deputy Director of Agriculture, Western Circle, Central Provinces, is granted combined leave for three months.

* * *

RAI SAHIB BHAIYALAL DUBE, Officiating Deputy Director of Agriculture, Northern Circle, Central Provinces, has been posted to the Western Circle, *vice* Mr. Maya Das on leave.

MR. S. T. D. WALLACE, B.Sc., Assistant Director of Agriculture, Nagpur, has been appointed to officiate as Principal, Agricultural College, Nagpur, *vice* Mr. Nand Kishore reverted as Extra Assistant Director of Agriculture, Jubbulpore.

Reviews

The Cultivation of Ragi in Mysore.—By LESLIE C. COLEMAN, M.A., Ph.D. [Department of Agriculture, Mysore State, Bulletin No. 11. Pp. 67+20 plates+1 map.]

THIS bulletin records the results of a very complete series of experiments conducted by the Mysore State Department of Agriculture with a view to the ultimate improvement of the *ragi* crop (*Eleusine coracana*). This millet covers over one-third of the total cultivated area of the State and is said to be the staple food of four-fifths of its people. The crop is grown chiefly on the laterite soils of the State, which, as a rule, are poor in the more important plant food constituents. These soils in addition possess a low water-holding capacity and dry out rapidly. It, therefore, follows that in addition to varietal tests, experiments with manures and tillage are of first-rate importance.

From a perusal of the bulletin it will be seen that considerable success has been obtained along these three main lines of investigation. For instance, one of the selected strains, Hebbal 22, possessing drought-resistant qualities and freedom from 'shedding' gives a superior yield of grain and straw estimated at over 7 per cent. above the best purified local variety. It is considered that it will not prove a difficult matter to extend the area under this variety to 50,000 acres, representing a money outturn of Rs. 25 lakhs per annum, within the next 5 years. Manurial experiments have demonstrated the great value of leguminous green manures, and it is estimated that the value of a suitable green manure is equivalent to the application of from 6 to 10 cartloads of cattle manure. In the tests,

cowpeas and sann-hemp have proved the most suitable green manure plants, and, as the cost of sowing and ploughing in green manure does not exceed Rs. 5 per acre, these results may be considered of first-rate economic importance to *ragi* cultivation in the Mysore State.

Good results have also been obtained by earlier and better cultivation which enables the soil to absorb early rains and which increases its moisture capacity. Illustrations are given of the most suitable cultivation implements including barshare plough, which, on account of its easy adjustment to wear, has proved the most satisfactory type. The disc harrow has proved useful for preliminary cultivation in cases where there is insufficient moisture for the plough. It is stated that after several runs with this implement it is possible to produce sufficient mulch in even the hardest soils to save the moisture from the first showers which is too often lost in hard baked land. The cost of the implement, however, is rather a serious factor against its general introduction.

The last chapter of the book is devoted to diseases and pests of *ragi* and in the appendix a great deal of useful information regarding the crop is given.

Dr. Coleman and his staff are to be congratulated on the thorough manner in which the improvement of this important crop has been studied and the large measure of success which has attended their efforts.—[EDITOR.]

* * *

Ammonification of Manure in Soil. By J. W. BRIGHT and H. J. CONN.
[New York Agr. Expt. Sta. Technical Bulletin No. 67, April, 1919.]

THIS bulletin is divided into two parts.

Part I by J. W. Bright deals with the soil organisms which take part in the ammonification of manure. The author finds that non-spore-formers like *Ps. fluorescens* and *Ps. caudatus* are the most important ammonifiers of manure in the soil, while spore-formers like *B. cereus* do not take part in the process. The author's results are based chiefly on the evidence furnished by platings before and after addition of organic manure. The statement that there

is no evidence that *B. cereus* takes part in this process has to be accepted, however, with caution, because the author has already shown that although colonies of *B. cereus* do not develop in the presence of *Ps. fluorescens*, still *B. cereus* is a vigorous ammonifier converting large amounts of organic nitrogen into ammonia acting by itself when inoculated in soil which has been sterilized after addition of organic manure.

Besides, although large number of non-spore-formers like *B. fluorescens* have been observed to be active after addition of organic manures, their true function may not be ammonification, but probably the destruction of carbohydrate material and the production of CO_2 as indicated by a close similarity of curves for bacterial numbers and CO_2 in many other cases.

In the second part, which is by H. J. Conn, we find a detailed description of the two organisms *Ps. fluorescens* and *Ps. caudatus* as an aid to their identification by others. A bibliography is appended.—[N. V. J.]

NEW BOOKS

ON AGRICULTURE AND ALLIED SUBJECTS

1. The House-fly : Its Life-History and Practical Measures for its Suppression, by Major E. E. Austen. Pp. 52. [London : British Museum (Natural History).] Price, 1s. 6*d.* net.
2. The Mason-Wasps, by J. Henri Fabre. Translated by Alexander Teixeira de Mattos. Pp. vi+318. (London : Hodder and Stoughton, n.d.) Price, 7s. 6*d.* net.
3. General Science : First Course, by L. Elhuff. Pp. vii+435. (London : G. G. Harrap and Co., Ltd.) Price, 5s. net.
4. The Soil : An Introduction to the Scientific Study of the Growth of Crops, by Sir A. D. Hall. Third Edition, revised and enlarged. Pp. xv+352. (London : John Murray.) Price, 7s. 6*d.* net.
5. The Geography of Plants, by Dr. M. E. Hardy. Pp. xii+327. (Oxford : At the Clarendon Press.) Price, 7s. 6*d.* net.
6. The Small Farm and its Management, by Prof. J. Long. Second Edition. Pp. 328. (London : J. Murray.) Price, 7s. 6*d.* net.
7. Imperial Institute : Indian Trade Inquiry : Reports on Oil Seeds. Pp. ix+144. (London : J. Murray.) Price, 6s. net.
8. Practical Hardy Fruit Culture, by Richard Staward. Pp. 216. (London : The Swarthmore Press, Ltd.) Price, 6s. net.
9. A Text-book of Organic Chemistry, by E. de B. Barnett. Pp. xii+380. (London : J. and A. Churchill.) Price, 15s. net.
10. Animal Food Stuffs : Their Production and Consumption, with Special Reference to the British Empire. A Study in Economic Geography and Agricultural Economics, by

Dr. E. W. Shanahan. Pp. viii+331. (London: George Routledge & Sons, Ltd.; New York: E. P. Dutton & Co.) Price, 10s. 6d. net.

11. Flax Culture and Preparation, by Fred. Bradbury. Pp. xii+154. (London: Sir Isaac Pitman & Sons, Ltd.) Price, 9s. net.

THE following publications have been issued by the Imperial Department of Agriculture in India since our last issue:—

Memoirs.

1. The Rice Leaf-hoppers (*Nephotettix bipunctatus*, Fabr. and *Nephotettix apicalis*, Motsch.), by C. S. Misra, B.A. (Entomological Series, Vol. V, No. 5.) Price, R. 1-8 or 3s.
2. *Lantana* Insects in India. Being the Report of an Inquiry into the Efficiency of Indigenous Insect Pests as a Check on the Spread of *Lantana* in India, by Rao Sahib Y. Ramachandra Rao, M.A., F.E.S. (Entomological Series, Vol. V, No. 6.) Price, Rs. 2-4-0 or 4s. 6d.
3. Studies on the Root Nodule Organism of the Leguminous Plants, by N. V. Joshi, M.Sc., B.A., L.Ag. (Bacteriological Series, Vol. I, No. 9.) Price, R. 1-4 or 2s. 6d.

Bulletin.

1. The Orange: A Trial of Stocks at Peshawar, by W. Robertson Brown. (Bulletin No. 93.) Price, As. 6.

PUBLICATIONS OF THE IMPERIAL DEPARTMENT OF AGRICULTURE OF INDIA

TO BE HAD FROM

THE OFFICE OF THE AGRICULTURAL ADVISER TO THE GOVERNMENT OF INDIA, PUSA, BIHAR.
and from the following Agents :—

- | | |
|--|---|
| (1) THACKER, SPINK & CO., CALCUTTA. | (7) THACKER & CO., LTD., BOMBAY. |
| (2) W. NEWMAN & CO., CALCUTTA. | (8) SUNDER PANDURANG, BOMBAY. |
| (3) RAI M. C. SARKAR BAHADUR & SONS, CALCUTTA. | (9) RAI SAHIB M. GULAB SINGH & SONS, LAHORE. |
| (4) HIGGINBOTHAMS, LTD., MADRAS. | (10) MANAGER, EDUCATIONAL BOOK DEPOT, NAGPUR. |
| (5) THOMPSON & CO., MADRAS. | |
| (6) D. B. TARAPOREVALA, SONS & CO., BOMBAY. | |

A complete list of the publications of the Imperial Department of Agriculture in India can be obtained on application from the Agricultural Adviser to the Government of India, Pusa, Bihar, or from any of the above-mentioned Agents.

These publications are :—

1. *The Agricultural Journal of India*. A Journal dealing with subjects connected with agricultural economics, field and garden crops, economic plants and fruits, soils, manures, methods of cultivation, irrigation, climatic conditions, insect pests, fungus diseases, co-operative credit, agricultural cattle, farm implements, and other agricultural matters in India. Illustrations, including coloured plates, form a prominent feature of the Journal. It is edited by the Agricultural Adviser to the Government of India, and is issued once every two months or six times a year. *Annual Subscription*, Rs. 6 or 9s. 6d., including postage. *Single copy*, R. 1-8 or 2s.
2. Scientific Reports of the Agricultural Research Institute, Pusa (including the Report of the Imperial Cotton Specialist).
3. Annual Report on the Progress of Agriculture in India.
4. Proceedings of the Board of Agriculture in India.
5. Proceedings of Sectional Meetings of the Board of Agriculture.
6. Memoirs of the Imperial Department of Agriculture in India :
 - (a) Botanical Series.
 - (b) Chemical Series.
 - (c) Entomological Series.
 - (d) Bacteriological Series.
 - (e) Veterinary Series.
7. Bulletins issued by the Agricultural Research Institute, Pusa.
8. Books.

The following are the publications of the last two years :—

- Scientific Reports of the Agricultural Research Institute and College, Pusa (including the Report of the Imperial Cotton Specialist), for the year 1917-18. Price, R. 1-4 or 2s.
- Scientific Reports of the Agricultural Research Institute, Pusa (including the Report of the Imperial Cotton Specialist), for the year 1918-19. Price, R. 1-4 or 2s.
- Report on the Progress of Agriculture in India for the year 1917-18. Price, R. 1-8 or 2s. 3d.
- Report on the Progress of Agriculture in India for the year 1918-19. Price, R. 1-8 or 2s. 3d.
- Proceedings of the Board of Agriculture in India, held at Pusa on the 1st December, 1919, and following days (with Appendices). Price, As. 12 or 1s. 3d.
- Proceedings of the Second Meeting of Mycological Workers in India, held at Pusa on the 20th February, 1919, and following days. Price, As. 11 or 1s.
- Proceedings of the First Meeting of Agricultural Chemists and Bacteriologists, held at Pusa on 24th February, 1919, and the following days. Price, R. 1 or 1s. 6d.

AGRICULTURAL PUBLICATIONS—(Oonold.)

Proceedings of the First Meeting of Veterinary Officers in India, held at Lahore on the 24th March, 1919, and following days (with Appendices). Price, As. 8 or 9d.

Proceedings of the Third Entomological Meeting, held at Pusa in February 1919. (*In the press.*)

MEMOIRS OF THE DEPARTMENT OF AGRICULTURE IN INDIA

BOTANICAL SERIES

- Vol. IX, No. IV. Studies in Indian Sugarcanes, No. 3. The Classification of Indian Canes with special reference to the Sarethra and Sunnabile Groups, by C. A. BARBER, sc.D. Price, R. 2-4 or 3s.
- Vol. IX, No. V. *Phytophthora Meadti* n. sp. on *Hevea brasiliensis*, by W. MCRAE, M.A., B.Sc., F.L.S. Price, R. 1-4 or 2s.
- Vol. X, No. I. The Rice Worm (*Tylenchus angustus*) and its Control, by E. J. BUTLER, M.B., F.L.S. Price, R. 1-4 or 2s.
- Vol. X, No. II. Studies in Indian Sugarcanes, No. 4. Tillering or Underground Branching, by C. A. BARBER, C.I.E., sc.D., F.L.S. Price, R. 4-4 or 7s.
- Vol. X, No. III. Studies in Indian Sugarcanes, No. 5. On testing the suitability of sugarcane varieties for different localities, by a system of measurements. Periodicity in the growth of the sugarcane, by C. A. BARBER, C.I.E., sc.D., F.L.S. Price, R. 1-12 or 2s.
- Vol. X, No. IV. A *Pythium* Disease of Ginger, Tobacco and Papaya, by L. S. SUBRAMANIAM. Price, R. 1-8 or 2s. 6d.
- Vol. X, No. V. Studies in the Pollination of Indian Crops, 1, by A. HOWARD, GABRIELLE L. C. HOWARD, and ABDUR RAHMAN KHAN. Price, R. 1-4 or 2s. 6d.
- Vol. X, No. VI. "Kumpta" Cotton and its Improvement, by G. L. KOTTUR, B. Ag. (*In the press.*)
- Vol. XI, No. I. Some Aspects of the Indigo Industry in Bihar. Part I. The Wilt Disease of Indigo. Part II. The factors underlying the seed production and growth of Java Indigo, by ALBERT HOWARD, C.I.E., M.A., and GABRIELLE L. C. HOWARD, M.A., with the assistance of CHOWDHURY RAMDHAN SINGH and MAULVI ABDUR RAHMAN KHAN. (*In the press.*)
- Vol. XI, No. II. Studies in Diseases of the Jute Plant. (1) *Diplodia Corechori*, Syd., by F. J. F. SHAW, D.Sc., A.R.C.S., F.L.S. (*In the press.*)

CHEMICAL SERIES

- Vol. V, No. II. "Heart Damage" in Baled Jute, by R. S. FINLOW, B.Sc., F.I.C., F.C.S. Price, R. 1 or 1s. 6d.
- Vol. V, No. III. Experiments on the Improvement of the Date Palm Sugar Industry in Bengal, by HAROLD E. ANNETT, B.Sc., F.I.C.; GOSTA BEHARI PAL, M.Sc.; and INDU BHUSHAN CHATTERJEE, L.Ag. Price, R. 1 or 1s. 6d.
- Vol. V, No. IV. Cholam (*A. Sorghum*) as a Substitute for Barley in Malting Operations, by B. VISWANATH, T. LAKSHMANA ROW, B.A., and P. A. RAGHUNATHASWAMI AYYANGAR. Dip. Ag. Price, As. 12 or 1s.
- Vol. V, No. V. The Phosphate Requirements of some Lower Burma Paddy Soils, by F. J. WARTH, M.Sc., B.Sc., and MAUNG PO SHIN. Price, R. 1-12 or 3s. 3d.
- Vol. V, No. VI. Absorption of Lime by Soils, by F. J. WARTH, M.Sc., B.Sc., and MAUNG PO SAW. Price, R. 1-2 or 2s.
- Vol. V, Nos. VII & VIII. The Gases of Swamp Rice Soils, V—A Methane-oxidizing Bacterium from Rice Soils, by P. A. SUBRAHMANYA AYYAR B.A.; and The Gases of Swamp Rice Soils, VI—Carbon Dioxide and Hydrogen in relation to Rice Soils, by W. H. HARRISON, D.Sc. (*In the press.*)
- Vol. V, No. IX. The Retention of Soluble Phosphates in Calcareous and Non-calcareous Soils, by W. H. HARRISON, D.Sc. and SURENDRA LAL DAS, M.Sc. (*In the press.*)

ENTOMOLOGICAL SERIES

- Vol. V, No. V. The Rice Leaf-hoppers (*Nephotettix bipunctatus*, Fabr. and *Nephotettix apicalis*, Motsch.), by O. S. MISRA, B.A. Price, R. 1-7 or 3s.
- Vol. V, No. VI. *Lantana* Insects in India. Being the Report of an Inquiry into the Efficiency of Indigenous Insect Pests as a Check on the Spread of *Lantana* in India, by RAO SAHIB Y. RAMACHANDRA RAO, M.A., F.E.S. Price, R. 2-4 or 4s. 6d.
- Vol. VI. Life-histories of Indian Insects: Microlepidoptera, by T. BAINBRIDGE FLETCHER, B.N., F.L.S., F.E.S., F.Z.S. (*In the press.*)

ENTOMOLOGICAL SERIES—(Conold.)

- Vol. VI, No. I. Pterophoridae.
 Vol. VI, No. II. Carposinidae, Phaloniadae, Tortriciadae and Eucosmidae.
 Vol. VI, No. III. Gelechiidae.
 Vol. VI, No. IV. Cosmopterygidae, Oecophoridae, Phycophilidae, Xyloryctidae, Stenomidae and Orneodidae.
 Vol. VI, No. V. Heliozelidae, Heliodinidae, Glyphipterygidae, Blastobasidae and Hyponomeutidae.
 Vol. VI, No. VI. Gracillariidae.
 Vol. VI, No. VII. Epermeniidae, Plutellidae and Lyonetiidae.
 Vol. VI, No. VIII. Tineidae and Nepticulidae.
 Vol. VI, No. IX. Appendix.
 Vol. VII, Nos. 1 & 2. New Indian Gall Midges (Diptera), by E. P. FELT, and Description of a Rhinocyphine larva from Shillong, by MAJOR F. C. FRASER, I.M.S. Price, As. 12 or 1s. 6d.

BACTERIOLOGICAL SERIES

- Vol. I, No. VIII. Pebrine in India, by C. M. HUTCHINSON, B.A. (*In the press.*)
 Vol. I, No. IX. Studies on the Root Nodule Organism of the Leguminous Plants, by N. V. JOSHI, M.Sc., B.A., L. Ag. Price, R. 1-4 or 2s. 6d.

VETERINARY SERIES

- Vol. III, No. I. The Vitality of the Rinderpest Virus outside the Animal Body under Natural Conditions, by A. W. SHILSTON, M.R.C.V.S. Price, As. 12 or 1s.
 Vol. III, No. II. The Virulence of Tubercle Bacilli isolated from Bovine Lesions in India, by A. L. SHEATHER, B.Sc., M.R.C.V.S. (*In the press.*)
 Vol. III, No. III. Bovine Lymphangitis, by A. L. SHEATHER, B.Sc., M.R.C.V.S. (*In the press.*)

BULLETINS ISSUED BY THE AGRICULTURAL RESEARCH INSTITUTE, PUSA

- No. 81. The Value of Phosphatic Manures in India and the Possibility of their Manufacture on a Larger Scale. Being evidence submitted to the Committee appointed to discuss this question (Subject IX) at the Meeting of the Board of Agriculture, Poona, 1917. Edited, with an Introduction, by W. A. DAVIS, B.Sc., A.C.G.I. Price, As. 4 or 5d.
 No. 82. The Improvement of the Indigenous Methods of *Gur* and Sugar making in the United Provinces, by WILLIAM HULME and R. P. SANGHI. Price, As. 8 or 9d.
 No. 83. Progress of the Sugarcane Industry in India during the Years 1916 and 1917. Being Notes submitted to the Meeting of the Board of Agriculture in India, Poona, 1917. Edited, with an Introduction, by C. A. BARBER, C.I.E., Sc.D., F.L.S. Price, As. 5 or 6d.
 No. 84. The Best Means of Rapidly Increasing the Outturns of Food Crops by Methods within the Power of the Agricultural Department. Being Notes submitted to the Meeting of the Board of Agriculture in India, Poona, 1917. Edited, with an Introduction, by J. MACKENNA, C.I.E., I.C.S. Price, As. 4 or 5d.
 No. 85. Soil Drainage, by R. G. ALLAN, M.A. Price, As. 4 or 5d.
 No. 86. A New Nematode causing Parasitic Gastritis in Calves, by A. L. SHEATHER, B.Sc., M.R.C.V.S. Price, As. 4 or 5d.
 No. 87. A Contribution to our Knowledge of South Indian Coccidæ, by T. V. RAMAKRISHNA AYYAR, B.A., F.E.S., F.Z.S. Price, As. 14 or 1s. 6d.
 No. 88. Cawnpore-American Cotton: An Account of Experiments in its Improvement by Pure Line Selection and of Field Trials, 1913-1917, by B. C. BURT, B.Sc., and NIZAMUDDIN HAIDER. Price, As. 10 or 1s.
 No. 89. Second Hundred Notes on Indian Insects. Price, R. 1-4 or 2s.
 No. 90. A Malarial Parasite in the Blood of a Buffalo, by A. L. SHEATHER, B.Sc., M.R.C.V.S. Price, As. 6 or 7d.
 No. 91. Notes on Practical Salt Land Reclamation, by G. S. HENDERSON, N.D.A., N.D.D. Price, As. 6.
 No. 92. *Syngamus laryngeus* in Cattle and Buffaloes in India, by A. LESLIE SHEATHER, B.Sc., M.R.C.V.S., and A. W. SHILSTON, M.R.C.V.S. Price, As. 6.
 No. 93. The Orange: A Trial of Stocks at Peshawar, by W. ROBERTSON BROWN. Price, As. 6.

**BULLETINS ISSUED BY THE AGRICULTURAL RESEARCH
INSTITUTE, PUSA—(Concl'd.)**

- No. 94. A Preliminary Note on the Behaviour in North India of the first batch of Sugarcane Seedlings distributed from the Sugarcane-breeding Station, Coimbatore, by T. S. VENKATRAMAN, B.A. Price, As. 8.
- No. 95. A Note on the Treatment of Surra in Camels by Intravenous Injections of Tartar Emetic, by H. E. CROSS, M.R.C.V.S., D.V.H., A.Sc. Price, As. 2.
- No. 96. A Summary of Experiments on Rice in Bihar and Orissa from 1912 to 1919, by G. C. Sherrard, B.A. (*In the press.*)
- No. 97. *Ustilago Cramerie*, Koern, on *Setaria italica*, by S. SUNDERARAMAN, M.A. (*In the press.*)
- No. 98. The Course that Surra runs in Camels when Naturally Contracted and when Artificially Inoculated, by H. E. CROSS, M.R.C.V.S., D.V.H., A.Sc. (*In the press.*)
- No. 99. The Course that Camel Surra runs in Ponies, Buffaloes and other Animals, by H. E. CROSS, M.R.C.V.S., D.V.H., A.Sc. (*In the press.*)

INDIGO PUBLICATIONS

- No. 1. A Study of the Indigo Soils of Bihar. The Urgent Necessity for Immediate Phosphate Manuring if Crops are to be Maintained, by W. A. DAVIS, B.Sc., A.C.G.I. Price, R. 1-4 or 2s.
- No. 2. Present Position and Future Prospects of the Natural Indigo Industry, by W. A. DAVIS, B.Sc., A.C.G.I. Price, As. 10 or 1s.
- No. 3. The Loss of Indigo caused by Bad Settling and the means of obviating this. The use of Dhak Gum—its Effect on Yield and Quality, by W. A. DAVIS, B.Sc., A.C.G.I. Price, As. 4 or 5d.
- No. 4. The Future Prospects of the Natural Indigo Industry: The Effect of Superphosphate Manuring on the Yield and Quality of the Indigo Plant, by W. A. DAVIS, B.Sc., A.C.G.I. Price, As. 4 or 5d.
- No. 5. An Improved Method of preparing Indican from Indigo-yielding Plants, by BHAILAL M. AMIN, B.A. Price, As. 2 or 3d.
- No. 6. The Effect of Manuring with Superphosphate and Sannai on the Yield of Crops on Indigo Planters' Estates in Bihar—especially of Rabi Crops in the Season 1918-1919, by W. A. DAVIS, B.Sc., A.C.G.I. Price, As. 6.
- No. 7. The Conditions affecting the Quality of the Java Indigo Plant (Leaf yield and richness of the leaf in indigotin), by W. A. DAVIS, B.Sc., A.C.G.I. (*In the press.*)

BOOKS

- "Indian Insect Pests," by H. MAXWELL-LEFROY, M.A., F.E.S., F.Z.S. Price, R. 1-8 or 2s (*Out of print.*)
- "Indian Insect Life," by H. MAXWELL-LEFROY, M.A., F.E.S., F.Z.S.; and F. M. HOWLETT, B.A. 786 pp. Price, R. 20 or 30s. (*Out of print.*)
- "Wheat in India," by ALBERT HOWARD, M.A., A.R.C.S., F.L.S.; and GABRIELLE L. C. HOWARD, M.A. 298 pp. Price, R. 5 or 7s. 6d.
- "A Description of the Imperial Bacteriological Laboratory, Muktesar: Its Work and Products," by Major J. D. E. HOLMES, M.A., D.Sc., M.R.C.V.S. Price, As. 8 or 9d.
- "Agriculture in India," by JAMES MACKENNA, M.A., I.C.S. Price, As. 4 or 5d.
- "Some Diseases of Cattle in India. A Handbook for Stock-owners." Price, As. 8 or 9d.
- "The Importance of Bacterial Action in Indigo Manufacture," by C. M. HUTCHINSON, B.A. Price, As. 2 or 3d.
- "Report of the Proceedings of the Second Entomological Meeting, held at Pusa on the 5th-12th February, 1917." Price, R. 3.

Report of the Indian Cotton Committee. Vol. I, Report; Vol. II, Maps and Plans. Price, R. 1 per volume. (Superintendent, Government Printing, India, Calcutta.)

VOL. XV, PART VI

November 1920

THE AGRICULTURAL JOURNAL OF INDIA



EDITED BY

The Agricultural Adviser to the Government of India

PUBLISHED FOR

THE IMPERIAL DEPARTMENT OF AGRICULTURE IN INDIA

BY

THACKER, SPINK & CO., CALCUTTA

W. THACKER & CO., 2, CREED LANE, LONDON

Price R. 1-8 or Two Shillings

Agents for the Sale of Government Publications

IN EUROPE

- Constable & Co., 10, Orange Street, Leicester Square, London, W.C.
Kegan Paul, Trench Trübner & Co., 68-74, Carter Lane, E.C., and 25, Museum Street, London, W.C.
Bernard Quaritch, 11, Grafton Street, New Bond Street, London, W.
P. S. King & Sons, 2 & 4, Great Smith Street, Westminster, London, S.W.
H. S. King & Co., 65, Cornhill, E.C., and 9, Pall Mall, London, W.
Grindlay & Co., 54, Parliament Street, London, S.W.
Luzac & Co., 46, Great Russell Street, London, W.C.
W. Thacker & Co., 2, Creed Lane, London, E.C.
T. Fisher Unwin, Limited, 1, Adelphi Terrace, London, W.C.
B. H. Blackwell, 50 & 51, Broad Street, Oxford.
Deighton, Bell & Co., Ltd., Cambridge.
Oliver & Boyd, Tweeddale Court, Edinburgh.
E. Ponsonby, Ltd., 116, Grafton Street, Dublin.
Ernest Leroux, 28, Rue Bonaparte, Paris.
Martinus Nijhoff, The Hague, Holland.

IN INDIA AND CEYLON

- Thacker, Spink & Co., Calcutta and Simla.
W. Newman & Co., Calcutta.
R. Cambay & Co., Calcutta.
S. K. Lahiri & Co., Calcutta.
B. Bannerjee & Co., Calcutta.
The Indian School Supply Depot, 309, Bow Bazar Street, Calcutta, and 226, Nawabpur, Dacca.
Butterworth & Co. (India), Ltd., Calcutta.
Rai M. C. Sarkar Bahadur & Sons, 75-1-1, Harrison Road, Calcutta.
The Weldon Library, 18-5, Chowringhee Road, Calcutta.
Standard Literature Co., Ltd., Calcutta.
Lal Chand & Sons, Calcutta.
Higginbothams, Ltd., Madras.
V. Kaliyanarama Iyer & Co., Madras.
G. A. Natesan & Co., Madras.
S. Murthy & Co., Madras.
Thompson & Co., Madras.
Temple & Co., Madras.
P. R. Rama Iyer & Co., Madras.
E. M. Gopalakrishna Kone, Madura.
Thacker & Co., Ltd., Bombay.
A. J. Combridge & Co., Bombay.
D. B. Taraporevala, Sons & Co., Bombay.
Mrs. Radhabai Atmaram Sagoon, Bombay.
Sunder Pandurang, Bombay.
Gopal Narayan & Co., Bombay.
Ramchandra Govind & Son, Kalbadevi, Bombay.
A. H. Wheeler & Co., Allahabad, Calcutta, and Bombay.
N. B. Mathur, Superintendent, Nazir Kanun-i-Hind Press, Allahabad.
Rai Sahib M. Gulab Singh & Sons, Mufid-i-Am Press, Lahore.
A. Chand & Co., Lahore, Punjab.
Ram Krishna & Sons, Lahore.
Superintendent, American Baptist Mission Press, Rangoon.
Manager, the "Hitavada," Nagpur.
S. C. Talukdar, Proprietor, Students & Co., Cooch Behar.
A. M. & J. Ferguson, Colombo, Ceylon.
Manager, Educational Book Depôts, Nagpur and Jubbulpore.*
Manager of the Imperial Book Depot, 63, Chandney Chauk Street, Delhi.*
Manager, "The Agra Medical Hall and Co-operative Association, Ltd." (Successors to A. John & Co., Agra.)*
Superintendent, Basel Mission Book and Tract Depository, Mangalore.*
P. Varadachary & Co., Madras.*
H. Liddell, Printer, etc., 7, South Road, Allahabad.*
D. C. Anand & Sons, Peshawar.*
Ram Dayal Agarwala, 184, Katra, Allahabad.*
Manager, Newal Kishore Press, Lucknow.*

* Agents for the sale of Legislative Department Publications only.

CONTENTS

(VOL. XV, PART VI.)

ORIGINAL ARTICLES

	PAGE
THE LATE FRANCIS MILBURN HOWLETT, B.A., F.E.S.	589
SOME COMMON INDIAN BIRDS. NO. 6. THE WHITE WAGTAIL (<i>Motacilla alba</i>)	592
<i>T. Bainbrigge Fletcher, R.N., F.L.S., F.E.S., F.Z.S.; and C. M. Inglis, M.B.O.U., F.Z.S.</i>	592
THE EGYPTIAN COTTON PROBLEM: A REPORT TO THE EGYPTIAN GOVERNMENT. II	595
<i>H. Martin Leake, M.A., F.L.S.</i>	595
FLAX IN THE UNITED PROVINCES	616
<i>B. C. Burt, B.Sc., M.B.E.</i>	616
SOME OBSERVATIONS ON THE ROOTS OF FRUIT TREES	620
<i>W. Burns, D. Sc.; and L. B. Kulkarni, L.Ag.</i>	620
"THE AMERICAN BLIGHT" OR "THE WOOLLY APHIS," <i>Eriosoma (Schizoneura) lanigera</i> , HAUSMANN	627
<i>C. S. Misra, B.A.</i>	627
A PRELIMINARY NOTE ON THE EFFECT OF WATERINGS ON THE AMOUNT OF ACIDS SECRE- TED BY THE GRAM PLANT (<i>Vicia arietinum</i>)	636
<i>D. L. Sahasrabudde, L.Ag., B.Sc.</i>	636
MALFORMATION OF THE COTTON PLANT LEADING TO STERILITY	640
<i>G. L. Kottur, B.Ag.; and M. L. Patel, B.Ag.</i>	640

THE CHEMICAL AND BIOLOGICAL ASPECT OF <i>Bhata</i> SOIL OF CHANDKHURI EXPERIMENTAL FARM, CENTRAL PROVINCES	<i>A. R. Padmanabha Aiyer, B.A. ; and D. V. Bal, L.Ag. ..</i>	644
--	---	-----

SELECTED ARTICLES

THE GROWTH OF THE SUGARCANE, V	650
THE 1919 TUCUMAN SUGAR CROP	659
FARMYARD MANURE : ITS MAKING AND USE	667
RETTING FLAX IN WATER	675
A NEW THEORY OF THE ORIGIN OF SEA ISLAND COTTON	678

NOTES

NATALITE	682
GOAT'S RUMEN FOR DIALYSIS	682
PROSPECTS OF THE WORLD'S SUGAR MARKET	683
THE USE OF TRASH IN THE CULTIVATION OF RATOON CANES	685
SEED-RATE OF SUGARCANE	686
TREATMENT OF WOUNDS ON TREES	690
NEW IMPLEMENTS AT THE ROYAL SHOW	691
COTTON GROWING IN MESOPOTAMIA	694

PERSONAL NOTES, APPOINTMENTS AND TRANSFERS, MEETINGS AND CONFERENCES, ETC.	696
---	------------

REVIEWS

COW-KEEPING IN INDIA	699
CHARCOAL AS A WONDERFUL FERTILIZER	700

CORRESPONDENCE

MANURING OF ORANGE PLANTS	702
-----------------------------------	-----

NEW BOOKS ON AGRICULTURE AND ALLIED SUBJECTS 703

LIST OF AGRICULTURAL PUBLICATIONS IN INDIA FROM 1ST FEBRUARY TO 31ST JULY 1920	After p. 704
---	--------------

LIST OF ILLUSTRATIONS

	Frontispiece
	Facing Page
The White Wagtail (<i>Motacilla alba</i>)	Frontispiece
Plate XXXIV. The late Francis Milburn Howlett	590
„ XXXV. Root systems of orange trees	621
„ XXXVI. ditto ditto	622
„ XXXVII. Root system of guava tree	624
„ XXXVIII. Woolly Aphis on apple tree	628
„ XXXIX. ditto ditto	629
„ XL. ditto ditto	630
„ XLI. ditto ditto	631
„ XLII. Wax pores on body of Woolly Aphis	633
„ XLIII. Malformed cotton plants	640
„ XLIV. ditto ditto	641
„ XLV. ditto ditto	643
„ XLVI. <i>Dhaincha</i> in <i>bhata</i> and black soils	644
„ XLVII. Sann-hemp in <i>bhata</i> and black soil	645
„ XLVIII. <i>Cujanus indicus</i> , Cow-pea and Groundnut in <i>bhata</i> and black soils	646
„ XLIX. Sann-hemp in <i>bhata</i> soil	647
„ L. ditto ditto	648
„ LI. Branches of different orders in dissection of <i>Saccharum arundinaceum</i>	652
„ LII. Dissected stool of <i>Pansahi</i> sugarcane	653
„ LIII. Native cane in flower, Tucumán, Argentina	659
„ LIV. Typical POJ 213 cane in Tucumán	660

*The following Original Articles will appear in our next issue
(January 1921).*

- SOME COMMON INDIAN BIRDS. NO. 7. THE
MAGPIE ROBIN (*Copsychus saularis*) .. *T. Bainbrigge Fletcher,*
R.N., F.L.S., F.E.S.,
F.Z.S. ; and C. M.
Inglis, M.B.O.U., F.Z.S.
- THE EGYPTIAN COTTON PROBLEM. A REPORT
TO THE EGYPTIAN GOVERNMENT, III .. *H. Martin Leake, M.A.,*
F.L.S.
- SOME EXPERIENCE WITH POPPY GROWERS IN THE
UNITED PROVINCES *H. E. Annett, D.Sc., F.I.C.,*
M.S.E.A.C.
- FORESTS AND IRRIGATION: A PLEA FOR
SCIENTIFIC PRESERVATION AND GROWTH OF
STATE FORESTS AND SPECIAL CULTURES .. *S. K. Gurtu, M.A., M.Inst.*
C.E., F.R.S.A.
- THE CARE AND TREATMENT OF NEW SUGARCANE
IMPORTATIONS *T. S. Venkatraman, B.A.*
- LOCAL PRACTICES PREVALENT IN SOUTH INDIA
IN THE CONTROL OF INSECT PESTS .. *T. V. Ramakrishna Ayyar,*
B.A., F.E.S., F.Z.S.
- SOME OBSERVATIONS ON THE INFLORESCENCE
AND FLOWERS OF THE GRAPE *S. H. Prayag, M.Ag.*



THE WHITE WAGTAIL (MOTACILLA ALBA).

Original Articles

THE LATE FRANCIS MILBURN HOWLETT, B.A., F.E.S.

THE death of Francis Milburn Howlett at Mussoorie on August 20th was felt as a keen personal loss by those who knew him best, and leaves a gap in the ranks of scientific workers in India that can hardly be filled.

He was born at Wymondham in Norfolk in January 1877, and graduated with Honours from Christ's College, Cambridge, in 1899, and was thus 30 years of age in 1907 when he joined the Indian Agricultural Department, after working for some time as Professor of Biology at the Muir Central College, Allahabad.

His appointment as Second Imperial Entomologist at Pusa brought him into contact with H. Maxwell-Lefroy to whom he always evinced a characteristic loyalty. At Pusa he specialized on "flies," and prepared the sections on Mallophaga, Diptera, Cimicidæ and Anoplura for Lefroy's book "Indian Insect Life." He was also no mean artist, and the high standard of illustrations attained in its earlier days by the "Agricultural Journal of India" was due largely to his oft-sought advice and criticism, while his humorous sketches will long be remembered by his contemporaries at Pusa.

Besides contributions to departmental publications, he published a number of papers in scientific journals the subjects of which will give some idea of the special trend of his entomological work. They include :—

The Influence of Temperature upon the biting of Mosquitoes.
(*Parasitology*, December 1910.)

The Effect of Oil of Citronella on two species of *Dacus*.
(*Trans. Ent. Soc.*, October 1912.)

The Natural Host of *Phlebotomus minutus*, and
Insect Life-Histories and Parasitism. (Both in the *Indian
Journal of Medical Research*, Vol. I, No. 1, July 1913.)

A Trap for Thrips. (*Jour. Econ. Biol.*, London, March 1914.)

Chemical Reactions of Fruit Flies. (*Bull. Ento. Research*,
London, December 1915.)

He was elected President of the Zoological Section of the Sixth Indian Science Congress held in Bombay in January 1919, and gave an address on "Tactics against Insects."

At the time of his death he had completed the manuscript of a book on "The Control of Harmful Insects" which he intended to publish shortly.

His services were utilized by the Military Department in India in connection with the control of mosquitoes and of the flies which convey Surra in camels, and at Home in dealing with the disease-carrying insects that added to the danger of the war zones, including lice and sandflies.

Of his work in the special line that he had selected, Dr. Tragardh wrote in the "Bulletin of Entomological Research": "In my opinion, the investigations of Verschaffelt, Dewitz, and Howlett, if regarded in the light of the researches of physiologists into chemotropism, are of an importance which cannot be overestimated, and will guide practical entomology into new lines. Intimate co-operation between vegetable chemistry and entomology in the question will surely provide us with good weapons in our fight with many insects against which we are at present absolutely helpless."

It is worth mentioning here two very interesting discoveries which he made.

One was with regard to fleas. In a course of experiments he discovered that fleas have an extreme dislike for wet grass, and that when forced to choose between sitting on wet grass, and on grass which has been sprinkled with kerosine oil, all the fleas would leave the wet grass, and crowd on to the grass covered with kerosine oil. This experiment has an obvious bearing on questions concerning the



The late FRANCIS MILBURN HOWLETT, B. A., F. E. S.,
Imperial Pathological Entomologist.

diffusion of plague, and helps to explain why plague ceases every year at the beginning of the rains, and does not start again until after the rains, either in the cold or hot weather, and also helps to explain why plague has never got a foothold in Bengal and other water-logged areas.

Another discovery was that certain kinds of mosquito larvæ could live for comparatively long periods in quite dry earth. Howlett's method of announcing his discovery to the scientific world was characteristic of the man. All he did was to send a tube containing some dust to a scientific exhibition, with a short note requesting that on arrival some water might be poured into the tube, which should then be covered with gauze. In due course mosquitoes emerged, and the success of the experiment acknowledged. Both experiments require and deserve verification and further investigation.

Howlett was a man of almost childlike simplicity and originality of outlook, and with many interests. He was the most delightful of companions and the truest of friends. He had the faults as well as the merits of the artistic temperament. Keenly alive to the possibilities of a new idea, old and half worked out schemes were apt to be jostled aside and displaced in the ardour of some new investigation. He was a born schoolmaster, delighted in teaching, and could make all subjects interesting, and had the gift of implanting in his disciples some of his own enthusiasm.

He was a combative apostle of Pure Research, and his disappearance from the ranks of scientists of this order will be a serious blow to the cause.

SOME COMMON INDIAN BIRDS.

No. 6. THE WHITE WAGTAIL (*MOTACILLA ALBA*).

BY

T. BAINBRIGGE FLETCHER, R.N., F.L.S., F.E.S., F.Z.S.,
Imperial Entomologist ;

AND

C. M. INGLIS, M.B.O.U., F.Z.S.

INDIA has many birds which visit the plains as winter tourists only, passing the summer months either in the hills or in "the back of beyond" far to the north of the mighty Himalayas. Everyone is familiar with the fact that ducks, for example, migrate in this way but it may be news to some of our readers that most of our common Wagtails also act in this manner, visiting India only in the cold weather and passing the summer in Northern Asia. About a dozen different species are found in India but only one (*Motacilla maderaspatensis*), a black species with a conspicuous white eyebrow, looking not unlike a magpie-robin but never carrying the tail erected, is a permanent resident. All are very similar in general build, being slenderly built, dainty-looking birds, mostly coloured in mixtures of black, white and grey, occasionally yellowish or greenish, their delicate slimness harmonizing well with their lightness of gait as they run with great speed after their quarry, never hopping, but sometimes making little sallies into the air, and constantly wagging their tails whose outer feathers are always white and conspicuous during flight; whence their popular name. Then, as Cunningham has well remarked, they are so alluringly tame, merely running on in front of one and expostulating at being disturbed;

and, if persistently followed along a narrow path, making off on a brief, undulating flight to pitch anew a little way ahead in a way that gives one the fullest opportunity of becoming familiar with them. They are so tame that they often come into verandahs of bungalows and pick up insects off the floor. The migrant species usually arrive in India during September and remain with us until the end of the cold weather, the White Wagtail leaving Bihar before the end of April.

Wagtails feed mostly on small insects, chiefly flies, small beetles, ants and caterpillars, but occasionally pick up seeds also. The insects eaten are not of any beneficial kinds and in many cases are injurious to crops, and therefore these birds as a whole must be reckoned amongst the farmer's friends. It is a pity that most of them are absent from India during the Rains, when insect life is so abundant. The particular species which we have selected as a representative of this group is the White Wagtail (*Motacilla alba*), which Dewar briefly describes as, general colour of plumage grey; face, chin, and throat white, back of head and nape black; a black patch on the breast, the remainder of lower plumage white; the wings white with much black on them; the middle tail-feathers black, the outer ones white. Our plate (Frontispiece) gives a good general idea of its appearance. It has a very pleasant note. It is found throughout most parts of India during the winter months but does not occur in Southern India nor South of Moulmein in Burma. The Masked Wagtail (*M. personata*) is by some authors regarded as a distinct species, but by others as a form of *M. alba*, from which it differs by the ear-coverts and sides of neck being always black, whereas in *M. alba* these parts are always whitewashed. The distribution of *M. personata* much resembles that of *M. alba*, but it does not occur east of Calcutta and is a constant resident, and breeds, in North-West India.

The White Wagtail is a regular visitor to England during its time of migration from the Continent of Europe and breeds in England at times and has been known to pair there with the Pied Wagtail (*M. lugubris*), a species which does not occur in India.

Its nest has been found there in such odd places as in a Sand Martin's burrow, in the middle of a strawberry bed, and amongst a Virginian creeper growing over trellis-work. The eggs are bluish-white, speckled with black. So far as we know, it never breeds in India, and Hume in his *Nests and Eggs of Indian Birds* omits the White Wagtail altogether but mentions the Masked Wagtail, *M. personata*, which is perhaps a subspecies of the White Wagtail, as breeding in Afghanistan in May and June, the nest being usually placed in holes, under large stones, in or near beds of rivers.

The habits of the White Wagtail resemble those of the Pied. Dr. A. G. Butler gives some interesting notes on the latter species, in the course of which he says, "their power of turning in the air is astounding; few insects, however eccentric their flight, can hope to escape them. If a Wagtail is on the ground and it sees an insect flying towards it, instead of starting madly forward to meet its prey, it excitedly watches all the insect's movements and suddenly (when the latter is almost overhead) the agile bird rises with a rapid spiral movement, which looks almost like a somersault, the snap of its mandibles is heard, and all is over." He also writes, "even when caught wild, most examples of *Motacilla* soon become tame if kindly treated; they are easy to feed, living for years upon crumbled household bread, yolk of egg and ants' cocoons, moistened (either by the addition of a little water or mashed potato) and a few insects, their larvæ or spiders from time to time."

As most species of Wagtails are not permanent residents and do not breed in India, they have not received legislative protection in most Provinces, except in Bengal where they are protected throughout the year and in Burma where they are protected in reserved forests from being hunted, shot, snared or trapped for purposes of trade.

THE EGYPTIAN COTTON PROBLEM.

A REPORT TO THE EGYPTIAN GOVERNMENT.

BY

H. MARTIN LEAKE, M.A., F.L.S.,
Director of Agriculture, United Provinces.

(Continued from Vol. XV, Pt. V, p. 501.)

III.

IN the above review I have attempted to bring into prominence the salient features of the Egyptian cotton problem. The subject is a wide one and touches at many points on several of the commonly accepted divisions of science. I may now attempt to collect these into some systematic scheme which will serve as a foundation on which to build the organization which will be required to attack the problem successfully and as an indication of the staff and equipment which will be required for this attack. It will, perhaps, be objected that no mention has been made of the commercial aspect which is concerned with the disposal of the crop. While recognizing the importance of this aspect to the country generally, I do not hold that it falls within the sphere of a Ministry of Agriculture as such. The primary work of that Ministry is completed when it has pointed the way to obtain the maximum yield of pure cottons, and it is only directly concerned with the subsequent disposal of the produce in as far as it may be necessary to protect the seed supply required for sowing and to ensure for this a condition of purity. This is, however, an important point—the end term of the series which commences with the single plant of the plant-breeder. Every link of the chain forming that series must be adequately guarded

and the last, no less than the first, will require consideration if the field of investigation is to be covered.

We can recognize in the above review four primary lines of investigation to which we apply the terms Economic, Botanical, Agricultural, and Commercial, and to these we may add certain collateral lines. These may, in like manner, be termed Entomological, Mycological, Bacteriological, and Physical. But let me not be misunderstood in this matter; the difference between the primary and collateral lines, as here defined, is not one of relative practical importance. The former are concerned directly with the plant and its produce, the latter with the subsidiary conditions of growth which make cultivation an economic proposition. The two groups are truly complementary, for it is as useless to produce a potentially valuable plant, if the conditions of growth do not permit it to develop its inherent qualities, as it is to control those conditions in the absence of a plant capable of reaping the full benefit of that control.

PRIMARY LINES.

I. Economic.

The essential economic considerations have been seen to include diversity of classes accompanied by uniformity within the class itself. That diversity is required to meet the needs of different sections of the trade; the demand for any particular class is, thus, to some extent, independent of the demand for other classes and the magnitude of the demand depends on the relative importance of the section mainly concerned in working up that class. A knowledge of the normal relative requirement of the different classes and the normal relative price of these, under conditions when supply and demand about balance, is of primary importance.

In view of the probable early disappearance of Egypt's monopolistic position with regard to certain classes of cotton, accurate information is also required of the developments taking place in all countries likely to encroach on that monopoly. Especial care requires to be taken in the collection of statistical information on both these heads.

II. Botanical.

(1) *Selection.* Selection requires to be conducted on two independent lines and work along both of these should be conducted simultaneously. In the first place, and this forms the most important immediate need, selection should be directed to isolating, and maintaining the purity of races yielding the standard classes of the present day. Such selection forms the basis of any scheme which aims at eliminating 'degeneration' which, in its ultimate form, is interpreted as due to an inherent plant character giving to the type a limited span of life.

Secondly, it must be directed to the discovery and subsequent isolation of new, and hitherto unrecognized, types, whether the novelty affects the quality of the cotton or the behaviour of the plant in the field. It will cover the search for such plants as develop improved lint, a higher ginning percent., a vigorous habit, accompanied by high yield or an early maturation.

(2) *Hybridization.* The aim of such work is, ultimately, identical with that of the latter form of selection. Here, however, the method is directed. But more than this is involved. We are still ignorant of the factors controlling many of even the more obvious plant characters and there is much preliminary work to be done in this direction.

(3) *Physiology.* Physiological investigation will bear on the general problem at several points. At each stage of its history the plant is in direct response to its environment and growth will be controlled by one or other of the factors composing that environment. In its broadest outline physiological investigation will be directed to determining the limiting factors throughout. In the more particular aspect it will be directed to determining the effect of root interference, the causes of bud and fruit shedding, and the effect of such factors as water-supply on quality of lint.

III. Agricultural.

In the direct sequence, which we have termed primary, agricultural investigation will carry on the tests of the pure races a stage further and will require facilities for working up a seed supply

of such as successfully pass these tests. Such tests must include not merely comparative trials in one area—for, as we have seen, not the least important aim will be the demarcation of type tracts—but in several areas. Trial grounds will thus be required in each well-defined tract. The working up of a seed supply, involving, as it does, a different set of conditions, and one which will effectively maintain purity, requires separate treatment.

Secondly, provision must be made for subsidiary lines of agricultural investigation, cultural and manurial experiments, and experiments on the water requirements of the field crop. Such investigations are linked, on the one hand, with the physiological work already referred to and, on the other, with the general agricultural problems of the country.

IV. *Commercial.*

I apply this term in the strictly limited sense defined above. The Agricultural Section can, at the most, produce what constitutes a mere fraction of the seed required for sowing, and purity will not be maintained without some organization to control the crop and to prevent admixture followed by degeneration, after the seed passes beyond direct Ministerial control.

COLLATERAL LINES.*

V. *Entomological.*

This section of the Ministry is the most highly organized of any at the present time. The subject, too, lies outside the scope of this Report. Reference is made to this line of investigation here merely with the object of indicating that I have not overlooked the

* A certain amount of criticism has been directed against the omission of any reference to chemistry in the list of subjects here enumerated. I think, however, it will be clear that such omission implies no disparagement of the work of the chemist. It must be remembered that I am not concerned with the activities of the Ministry in their entirety but merely with those activities as they concern the cotton problem. The centre of gravity is, thus, shifted, and my enumeration extends beyond those subjects which directly bear on that problem only to a degree sufficient to indicate how my proposals dovetail into the general organization. The subjects are necessarily dealt with incompletely and in a somewhat different order from that in which they would occur were a review of the entire activities of the Ministry under consideration.

subject and that I recognize that any proposals that I am led to make would be of little advantage did they not fit into the scheme as a whole.

VI. *Mycological.*

From the aspect of the cotton crop, pure and simple, there appears to be small field for mycological work though its importance may develop at any moment. From the point of view of the general activities of the Ministry as a whole there is, especially in relation to horticulture, considerable scope for mycological investigation.

VII. *Bacteriological.*

Such investigation is concerned with agriculture generally, and is concerned with the subject of cotton merely in as far as that forms one, although the most important, of the crops grown. Little work has been done on bacterial action in the soils of Egypt. The field is large, important and practically unexplored; there can be little doubt that such action is of considerable magnitude and, if controlled, capable of exerting considerable influence on crop development. On the one hand, the study connects up with purely agricultural investigation at such points as manurial and cultural experiment and, on the other, with the physical investigations on soil moisture, its movement and control.

VIII. *Physical.*

The most important line of physical investigation is, without doubt, that which concerns the relation between the level of the subsoil water (water table) and the rise of the Nile, whether that relation be direct or indirect through the canal system. As such, the subject is closely connected with the irrigation system. Considerable scope for investigation lies also in the direction of determining the permeability of soils of different character and the rate of surface tension flow through these. I am tempted to think that, by a control of such flow through cultural means, irrigation could be much reduced in tracts in which the presence of salts is not marked. This line of investigation is, thus, intimately connected with the purely agricultural cultural experiments.

IV.

I have briefly outlined eight lines of investigation using as a basis the commonly accepted divisions of science. These cover the field presented by the cotton problem of Egypt. It will be convenient if, before I proceed further and enquire in greater detail into the requirements both as regards equipment and organization if these investigations are to be carried out in an efficient manner, I outline the course that will be followed in the development of any particular race which it is desired to develop through the experimental, to the practical, stage. Such development concerns those sections which I have denoted primary. The close interrelation that exists between these four sections and the necessity for full continuity from one stage to the next, a continuity which organization must recognize and allow for, will thus become apparent.

In its simplest terms, then, the work of the Botanical Section will consist of the isolation by means of single plant cultures—and for the present purpose, these cultures may arise as direct selections or as the result of hybridization—of pure races of cotton. Of such races, in the earliest stages, only a small amount of seed will be available. This work is, further, centralized; reduction in the number of races has to be effected and such reduction must be accomplished by trial under conditions more nearly approaching those of the cultivators' fields. In particular, these trials must be carried out with a view to testing the relative suitability to the different environmental conditions found in the cotton growing tracts; in other words, trial requires to be made with a view to bringing into prominence any particular adaptability of the race to the type tracts to which reference has been made. Such work must, from its very nature, be decentralized.

As the result of such comparative trials under different environmental conditions the number of races which survive elimination will be comparatively small. For these, further trials on a field scale and an organization for multiplying up a seed supply under conditions which will ensure purity are required. The degree of supervision here required is such that direct and complete control by the Ministry is essential.

From the seed supply so produced distribution will be made to extra-Ministerial agencies and here, for the first time, direct contact with the public will be reached. As I have stated above, the amount of seed that can be procured under such rigid control will be, under any organization practicable, but an iota of that required to sow even one type tract. Control, and the organization which accompanies it, cannot, therefore, cease here. That seed must be issued to a circle of selected and more reliable cultivators with whom arrangements for the repurchase of the crop for the purpose of increasing the seed supply are possible. These cultivators will, in the following year, be supplied with a fresh stock from the directly controlled Government stock, while the seed recovered from them is issued to a further set of cultivators.

I may set out the above scheme in tabular form:—

- (1) Research—the isolation of races in a condition of purity.
- (2) Experimental trial—small cultures grown comparatively under differing environmental conditions.
- (3) Field trials in those tracts only which the trials under (2) have proved suitable.
- (4) Seed production—the bulk development of a pure seed supply.
- (5) Seed distribution—the organization of a seed supply sufficient to meet the full needs of the tract.

We are now in a position to consider the equipment that will be needed to allow the successful development of this scheme for passing from the experimental to the practical issue. At the foundation of the scheme is the Botanical Section which will require a *Research Farm*. On this farm will be conducted, by the botanical staff, all that work which aims ultimately at the production of pure races. With a three-year rotation and an area of 25 to 30 acres under cotton at one time, some 70—90 acres will be needed for this farm.

For the experimental trial of such races as result from the botanical research farm small experimental plots, totalling two to three acres, will be required and these must be repeated in each

recognized type tract. The number of races sufficiently promising to be subjected to such tests will be relatively small for any one season. Repetition is, however, an essence of the trial in order to reduce, as far as possible, the probable error, and the area here given will allow for the necessary repetitions to be made at each centre of trial. These areas are too small to form a unit in themselves and they may conveniently form part of an *Experimental Farm*.

An experimental farm will be required for each definite tract and will form the site on which will be conducted all the purely agricultural experiments including, in addition to the experimental trials just alluded to, the field trials forming the third stage of development. For each of these an area of some 150 acres will be required.

Seed multiplication demands a distinct area, or *Seed Farm*, with a minimum of 150 acres giving 50 acres of cotton. Specialization is here required to ensure purity. Again, one such farm is required for each type tract as defined above.

The seed derived from the seed farms is available for distribution and for this, as follows from what I have already said, no equipment in the form of land is needed.

We may now turn to the question of organization which will realize most completely the opportunities offered by the institution of such farms throughout the country.

As before, I may commence with the Botanical Section with its staff engaged in detailed investigation leading up to the establishment of pure races which, in the first instance, will amount to cultures each totalling in the neighbourhood of some 200 plants. From such cultures sufficient seed will be available to provide a supply for the experimental trials and also to multiply up, on the research farm, a seed supply of sufficient magnitude to sow 1-2 acres. Of those races which satisfy the preliminary experimental tests there will thus be sufficient seed to carry on to the seed farm which will be fully stocked in the third year.

The Agricultural Section with its staff controls the experimental farms and, by conducting the experimental trials, will have early opportunity to become familiar with the results of the work

PURE RACE

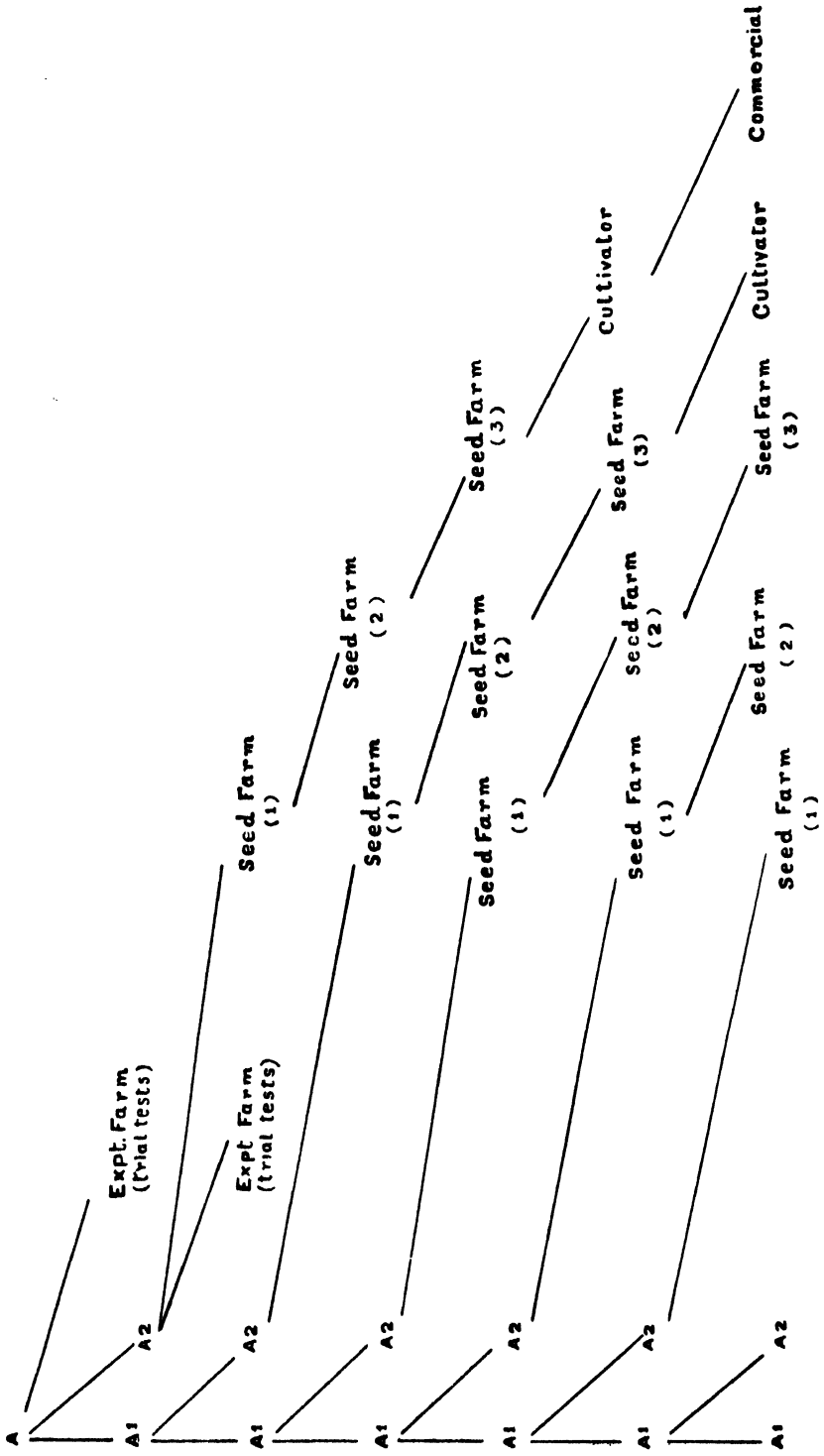

of the Botanical Section. It will also have the opportunity of forming an independent opinion of the value of the various races submitted for trial. Such check is valuable, affording, as it does, criticism from a different angle. The ultimate selection as to which races are to be continued and which discarded will rest jointly with the botanical and agricultural officers.

The seed farms are not so readily allocated. Their primary function is to work up a stock of pure seed and for this purpose botanical control and botanical examination are desirable. At the same time their location makes centralized control difficult while, for the same reason, they fall naturally into a district organization. We have here to strike the balance between the different disabilities, and I am inclined to think that the deciding factor should be one of individuality. It might be found advisable to adopt a middle course in this matter, placing the seed farm nearest to headquarters under the Botanical Section and the remainder under the respective district agricultural officers.

From the seed farm seed is issued to the cultivators, using that word in its widest sense. The selection of these is a matter for the district officer whose knowledge of his district should be such as to enable him to select the more reliable cultivators for the purpose. These may be actual cultivators or landholders who take a personal interest in the management of their estates. No doubt, too, valuable assistance could be rendered by the State Domains in this direction.

Before proceeding to the discussion of the wider distribution of seed with the precautions necessary to maintain purity I may summarize the scheme here outlined by a diagrammatic representation of the stages in the development of a pure race.

The diagram opposite indicates the method by which purity is maintained up to the commercial stage with which we have now to deal. It may be described as a series of waves originating with the research farm and passing from thence outwards. There is no backward flow of seed and the effect of any accidental cause leading to impurity is, thus, eliminated automatically.

The agricultural organization conceived in this scheme is one of a series of circles (to use an Indian term) based as far possible on type tracts and, therefore, since these are determined by environmental conditions, on climate. Each circle will be in charge of a circle officer whose work is dual. On the one hand, he will have control of an experimental farm and, on the other, he must develop an intimate knowledge of his circle and be in a position to select reliable men to whom he can entrust the cultivation of the seed issued from the seed farms. The former, to be properly developed, will require a great deal of personal work involving residence at the local headquarters at the busiest season, the latter frequent touring. The two functions are incompatible and if one or other line of work is not to be neglected, it seems essential that two officers should normally be allowed on the strength of each circle, an arrangement which has certain administrative advantages.

V.

With such an organization the maintenance of purity in the seed supply up to the stage when issue is first made to the public should not offer any great difficulty. We have now to consider the organization required for the further multiplication of that seed. It is here that the work of the Commercial Section will commence. Such a section is already in existence, but its activities have been confined to the supply of seed to the smaller cultivator and in 1919 approximately 30 per cent. of the cotton area was sown to seed so issued. Effective though that organization appears to be, it does not strike at the root of the problem. The seed is sown under no control and is of little or no value in increasing the supply of purer seed. Many of the larger cultivators too appear to be as careless as the smaller in this matter. It is immaterial whether the cause is ignorance or economic pressure, the effect is the same. Some more general control of the seed supply is needed, and such control must avoid the assumption by Government, as represented by the Ministry, of the function of a general dealer in seed. It would appear possible, by working along the lines indicated below, which are the outcome of conversations held by me in Alexandria, to

evolve a workable scheme which will ensure a certain standard of seed and, at the same time, provide the means of working up as far as may be necessary, while maintaining purity, the seed of the races which find their origin in the work of the Botanical Section.

The agricultural organization, as we have traced it, gives a seed supply sufficient to sow 500 acres. Allowing a margin for cases in which doubt attaches, the circle officer should be able to recover seed sufficient to sow 4,000 acres in the succeeding year. He will be able to locate the fields planted to that seed, but it will be beyond his means to recover the seed. Were he now to notify the ginners of the names of these growers with the area grown by each, it should be possible to intercept a fair proportion of the crop so grown as it comes into the ginneries and, by arrangement with the ginner, this could be ginned and the seed kept separate. Such seed will now receive a Government mark indicating that it is passed as taqawi (cotton seed used for sowing). I am here making various assumptions; I assume an intimate local knowledge on the part of the circle officer which will enable him to select reliable men; I assume the form that reliability takes will include a willingness to deal with the ginner selected, and I assume the existence of ginners who appreciate the importance of a guarded seed supply sufficiently to take the necessary trouble. From what I have been able to gather on these matters I am inclined to think that all these assumptions are well founded.

The ginner will now dispose of this taqawi seed in the normal course of his business but will keep a record for the information of the circle officer of the purchasers. The latter will thus be able, by a system of inspections during the succeeding year, to draw up a list of cultivators whose crop is sufficiently pure to serve as a source of taqawi. His selection will continue until he can find no more fields sufficiently pure to serve as a basis for seed supply—a condition which will occur during the early years of introduction—or until he has arranged for a sufficient supply, allowing for wastage, to meet the needs of the tract it is desired to plant to that kind.

I have described the organization with especial reference to the introduction of new races but, as I conceive it, that will not be the

main function of the scheme. I conceive the scheme, as described, merely as the preliminary stage in the evolution of a more complete one aimed at licensing the ginneries for taqawi.

The licensee will keep a record—

- (1) of the cultivators whose crops have gone to the production of taqawi, including a statement of the kind and the amount ;
- (2) of the persons to whom he has disposed of that seed, again including a statement of the kind and amount in each transaction.

In the selection of the seed cotton he will be guided by information supplied him by the circle officer aided by his own judgment. Where the source has not previously been inspected the seed cotton will be passed by the circle officer before it is ginned. All such taqawi seed will receive an official seal. The disposal of this seed will be subject to no further control than is indicated in (2).

These two lists, I suggest, should go to the Commercial Section of the Ministry, which will, thus, be in a position to collate the information with regard to seed supply by circles and to furnish the circle officers with such collated lists. The Commercial Section will also be responsible for extending the present distribution of seed to small holders,* for which it will obtain its supply from the sealed stock in the hands of the ginneries, but the supply to the larger holders will remain uncontrolled.

Under this scheme, when fully developed, the circle officer will be in possession, through the Commercial Section, of information as to the source of the seed from which a large proportion of the cotton in his circle is grown. He will thus be in a position to check to some extent the efficacy of the system of licensing. By using his local knowledge and concentrating on the larger holders he will be in a position to exercise control over the bulk of the cotton crop of his circle with the minimum of effort.

* The maximum amount issued in one lot is 10 ardebs (1 ardeb=5.44 bushels), or sufficient for 25 feddans (1 feddan=1.04 acres), representing a holding of between 50 and 75 feddans.

I am not here concerned so much with the development of a scheme practical in all its details—for such, practical experience and a local knowledge I do not possess is essential—as with outlining the main features any scheme, to be effective, must possess. Among such features I place the absence of penalty against the licensee. Success or failure will depend very largely on the goodwill of these.

In the "Agricultural Journal of Egypt," Vol. VIII, p. 69, an account is given of the system of control of taqawi instituted in connection with the control of cotton seed organized in 1917. The problem was then approached from a different standpoint and the control is, therefore, of a somewhat different nature to that which I have just suggested. It introduces control at a stage when that control is difficult of application and of a nature which, at first sight, appears to be restrictive. It is, for that reason, that I hesitated to suggest any control at this stage. The fact that the scheme has been developed without serious criticism from the financial interests affected makes it worth considering whether its institution on a permanent basis is not desirable. It is truly complementary to the scheme I have here proposed; there is no fundamental incompatibility between them, since they do not cover the same ground, and there should be no great difficulty in making the two dovetail into each other.

There appear to be a body of responsible ginnerers who fully recognize the importance of seed control and who would willingly undertake to make such returns. The position is more nearly that of a co-partnership for mutual benefit than one of enforcement of a restrictive order. For the services provided, Government guarantees a partial monopoly. In such a system any penalty beyond the removal of the license is inadmissible, and penalty, if any be required, will be imposed on the purchaser of non-guaranteed seed. The use to which the returns are put will end normally with the check which they will enable the district officer to make. Of one fact I am thoroughly convinced, if a scheme based on the goodwill and co-operation of the ginner be wanting in success, no scheme based on compulsion and the enforcement of penalties will lead to any better result.

It is recognized that any scheme such as I have outlined will throw a considerable amount of work on the circle officers to accomplish which a large portion of their time will be spent in touring. It is very largely recognition of this fact which is responsible for the suggestion that the normal senior staff of the circle shall be two ; the senior engaged mainly in touring and the district work and the junior on experimental work.

I have left reference to the economic aspect till the last because the discussion of the system outlined for the introduction of new, and the maintenance of purity in old, races throws a certain light on this. Statistical information is required both of the relative quantities of the different classes grown, of the value realized for these, and of the development of cottons capable of replacing these but grown in other countries. The system I have outlined for licensing ginneries and the information contained in the lists proposed in connection with that system should provide the materials for a very accurate estimate of the relative areas sown to the various races, and it is partly on this account that I have suggested the centralization of the work of abstracting these in the Commercial Section. Information with regard to prices and to the cottons produced in countries other than Egypt must be derived from external sources. With a definite idea of what information is required, it should not be difficult, by enlisting the services of the Empire Cotton Growing Committee, of the Fine Spinners Association, or of the International Federation, to arrange for statistics to be prepared in suitable form. The work of collating and recording this information requires no separate section and might conveniently be entrusted to the Commercial Section.

VI.

It will, perhaps, render these proposals clear if I refer to a few practical problems of the present day and show in what manner the scheme outlined will affect their development.

Mr. Bolland, some years ago, commenced a series of selections of the standard Egyptian cottons with a view to developing cultures of these which would give a more uniform product than is now

commonly attained. Of these, we may consider the Ashmouni culture. His method is, to describe it briefly, based on single plant selection of typical plants. The offspring of these single plants are grown separately, are examined in detail, and the seed of those plants which conform most nearly to the ideal of the Ashmouni type is harvested again separately, and sown the following year, as single plant cultures to form his Grade I crop. The seed of the remaining plants is harvested and bulked together to form his Grade II crop. In the following year the single plant Grade I cultures are again examined and from them single plants are selected. The remaining Grade I plants provide the next year's Grade II crop while the Grade II crop is sown as Grade III crop.

This process is repeated annually, the seed from the Grade III crop being issued to cultivators who grow it as Grade IV crop. Certain of these cultivators sow it under Ministerial supervision and the Ministry retains the right of purchase of the produce from this in the remainder of the Grade IV crop and, subsequently, control ceases and the amount of controlled seed at the disposal of the Ministry is, thus, limited to that from the controlled portion of the Grade IV crop, or enough to sow some 500—600 feddans.

This area is a mere fraction even of that which is sown to the Ashmouni seed distributed by the Commercial Section of the Ministry—over 100,000 feddans in 1919—and the Ministry is compelled, therefore, to seek its supply from ginneries. Now if this seed, selected on Mr. Bolland's scheme, is materially to affect the Ashmouni crop, and that presumably is the only justification for the labour incurred in that selection, the Ministry must check the sowings and trace the produce of those crops which it finds to be sufficiently pure to the ginneries, and must purchase the seed obtained from it to form what we may term a Grade V crop. Let us examine the practical aspect of this more closely.

In a letter recently received by the Ministry, I find the following remarks; they refer to produce from the uncontrolled section of the Grade IV crop:—

“The cotton was grown in two villages; the sample from the former shows a good coloured brown Ashmouni with as good staple

as we have seen this season ; there are, however, streaks of lighter coloured cotton which is curious, seeing that the seed is pure.....” The latter “is however entirely different to the first lot ; it contains a short wasty cotton and the class is barely F. G. F. It is surprising that it is supposed to be the same seed and perhaps you may be able to indicate the cause of deterioration.”

Again I have examined some samples of the seed cotton of this same Grade IV crop and have found it more mixed than the majority of commercial samples of Ashmouni that I have seen. In the former case, there is a distinct and large divergence between the produce raised from two identical lots of seed ; in the latter, admixture sufficient to render the produce less uniform than most of the uncontrolled Ashmouni crop.

The explanation cannot be given with certainty since there have been no independent observations of the various crops concerned, but it is probably this. In the first case both crops are sown with the controlled seed and in one instance germinations were successful and resowing unnecessary ; in the second instance, a large proportion of the crop consisted of second sowings and these were made with seed of different origin. The second case forms a parallel to the second instance of the first case and second sowings with seed of different origin was largely resorted to. In the first of these three instances only can the crop be truly considered to be of Mr. Bolland’s Ashmouni, the seed of the remainder is worthless for further distribution. Yet, the name is retained for the produce of all these cultures and the Ministry has no means of judging which are the reliable lots when it comes to purchase from the gins. The cessation of control after the Grade IV crop, therefore, renders it impossible to assure a supply of reliable seed for more than 500—600 feddans.

Were, now, an organization, such as I have outlined, to be in operation, the district officer would be in a position to see that these 500—600 feddans belonged to responsible persons who could be relied on to carry out any resowing with the same seed as that supplied. His local knowledge would, moreover, enable him to place the entire Grade IV crop in the hands of reliable persons. Even

supposing he fails to exercise any supervision over the distribution of the seed and the sowings, he would know where it was growing, could inspect the crops, see which of these maintained their purity, trace these to the ginneries, and so place at the disposal of the Ministry a yearly increasing supply of seed of known quality.

As a second instance, I may take the case of the Domains. Here Mr. Jeffreys has, for a number of years, devoted much labour to purifying the field crops of some of the more important varieties of Lower Egypt, notably Sakel and Assili. His method differs from the above and may be termed bulk selection. From the field crop, before general picking commences, he collected a bulk of seed taken only from those plants which correspond to the ideal of the type in question. The seed from the produce so collected is sown separately, rogued during the course of its growth and again gone through before harvest, and a similar amount of seed cotton of the most typical plants taken. The remaining seed is used to extend the area under the selected crop. In this way he has worked up an area of 10,000 feddans in which the crop is manifestly purer than any I have seen elsewhere, and it forms a distinct advance in uniformity on any of the crops commonly grown. He has also maintained on a fair scale in a state of considerable purity many other types, notably those evolved by Dr. Balls. We are here, however, only concerned with the two varieties, Sakel and Assili—of which a commercial seed supply is raised. Under present circumstances that seed, totalling 13,000—15,000 ardebs, is used partly by the Domains for sowing the area under their direct cultivation, using some 3,000 to 3,500 ardebs; partly for sowing a large area of leased lands, absorbing some 5,000 to 6,000 ardebs. The remaining seed is placed at the disposal of the Ministry which distributes it through the Commercial Section to cultivators in small lots. In all except the first case, and the extent of that is only sufficient to produce the same volume of seed yearly, control ceases. The subsequent cultivator is usually a small man who may, or may not, resow with seed of unknown origin.

Apart from the difficulty of re-collecting from a large number of small holders, the value of such seed for taqawi is very

questionable. Practically, therefore, the efforts made on the Domains merely result in the maintenance of a certain fairly constant volume of seed and there is no cumulative effect leading to increase.

Here, again, were there an organization such as I have outlined, the Domains seed would pass to the larger private estates, the district officer would be supplied with particulars of these, would inspect the crops, note which are the purest of these, trace them to the ginneries, and place at the disposal of the Ministry for distribution to the smaller cultivators an ever increasing source of supply of reliable seed.

VII.

I have indicated the essential points of an organization for the development of improved cottons and for the introduction of these on a commercial scale under conditions which will maintain a sufficient degree of purity. As described, the outstanding feature of that organization is continuity. But while continuity is essential to the successive stages of that development, such continuity is not possible in the organization. At least three sections of the Ministry, the Botanical, the Agricultural and the Commercial, are concerned. Success will depend on the maintenance of that continuity of work in spite of the discontinuity of agents, and the danger to the scheme lies at those points where the activities of two agencies meet. The function of organization should be the prevention of any hiatus occurring at these points and it should leave the maximum of freedom within the sections themselves.

This necessity for continuity requires to be emphasized. Recently a Cotton Research Board has been instituted with the underlying idea that the control of cotton research shall be undertaken by it, leaving the practical aspects of the problem to the Ministry. Such a division of functions, I think, is hardly consistent with the development of the continuity I hold to be essential for the successful development of the scheme. It institutes a duality of control which is almost certain to lead to a break in continuity, and to the establishment of the hiatus it is most desirable to avoid.

The idea underlying the separation of research from practice appears to be based on analogy with English conditions. Here the tendency is in the direction of such separation. I am inclined to think that this analogy is not a true one, especially in matters like agriculture. In England the farmer is educated and he appreciates the value of improved seed in crop production. He himself carries out the later stages of seed production inasmuch as he purchases a limited amount of pedigree seed and, from the crop produced from this, sows his entire area if the trial proves the superiority of the race under the local conditions. He is, thus, able and willing to pay a high price for pedigree seed, for the amount he has actually to purchase is small. It is that ability and willingness which makes the production of pedigree stock a financial proposition for the seedsman. In Egypt the conditions are far different. The cultivator is uneducated and even illiterate. There is no general recognition of the value of pedigree stock, no willingness to pay a high price for such, and, consequently, no encouragement for the seedsman and plant-breeder on a financial basis. Government must control the seed supply not only during the early stages but throughout. Not only, therefore, is continuity essential in the Research Section pure and simple, but that continuity must extend to the Commercial Section as well—a continuity which is not likely to be fostered by widening the breach between research and practice. Such continuity will, in my opinion, be best maintained by the institution of a Cotton Committee within the Ministry itself. This committee will be composed of the heads of the various sections concerned with the development of cotton and will sit under the presidency of the Under Secretary of State for Agriculture. It will deal with all matters of a general nature affecting more than one section and decide all questions of principle. It must, however, avoid any interference with the actual work of the individual sections once the general lines of policy have been decided. The decision as to what shall, or shall not, come before the committee must rest with the Under Secretary of State. Further, the committee will form a convenient body to deal with any matters of general principle now referred to the Under Secretary of State by Government. The committee should be flexible, and that

flexibility may be given to it by a power to co-opt members for particular purposes.

It, perhaps, carries me too far beyond the range of my terms of reference, but it may help to render my conception of the working of this Ministerial committee more clear, if I say that I look upon this committee merely as one of a number of such committees. It is, in my opinion, the most satisfactory means of dealing with all technical subjects which concern more than one section of the Ministry. On the one hand, they form a most convenient means for deciding, by mutual discussion, the lines of work of the different sections, so that these may dovetail into each other while, at the same time, automatically placing on record a Ministerial policy ; on the other, they form a definite body to which the Under Secretary of State can refer such references on technical matters as are received from Government and from which he can obtain an authoritative technical opinion.

The field presented by the cotton problem, however, in its entirety, extends beyond the scope of the Ministry of Agriculture. On the one side, there are the Domains. These form an enormous potential asset for the development of a controlled seed supply. I have already shown how it is that the Domains have failed to pass from a potential, to a practical, asset in this respect, and how it is that the very successful efforts are largely dissipated. A liaison requires to be effected between the Domains and the Ministry by which such questions as the varieties it is desirable that the Domains should grow, and the distribution of the seed raised on the Domains' land, can be settled. On the other side is the physical investigation for the conduct of which the Physical Service is relied on. It may also be remarked that the development of that work may raise important questions of water-supply which will involve the Irrigation Department. At least three extra-Ministerial bodies are, thus, concerned and between them some liaison is desirable.

I am aware that my proposal for the establishment of a committee within the Ministry will appear to undermine the position of the Cotton Research Board as at present instituted. This it undoubtedly does, but it indicates the desirability of a Board

occupying the same position with respect to the Ministry as the existing Board but with somewhat different functions. By the decree instituting that Board its function is defined as 'to combine, co-ordinate and extend the quality and yield of cotton grown in Egypt.' From the general aspect I have already indicated the undesirability of separating research from practice in the economic conditions prevalent in Egypt and, from the particular aspect, there appears to me the danger of a most undesirable duality of control. As I conceive it, the Board should serve the function of liaison agent between the Ministry of Agriculture and such extra-Ministerial bodies as are concerned with the cotton problem. The Ministerial note explaining the decree says 'the Board will maintain' close touch with cotton grower, ginners and spinners so as to know their 'needs.' I have dealt with this aspect elsewhere. It is the work enumerated by me as economic. I have suggested that this be performed by the Commercial Section and provision has already been made for it in the proposals I have already made.

(To be continued.)

FLAX IN THE UNITED PROVINCES.

BY

B. C. BURT, B.Sc., M.B.E.,

Deputy Director of Agriculture, Central Circle, U. P.

IN a recent number of "Capital" an extract was published from a note on the prospects of flax cultivation in the United Provinces, originally published at the request of the United Provinces Department of Industries in 1915, and which was reproduced at the time in the "Indian Trade Journal" and in several periodicals. When that note was written the price of agricultural produce had not been materially affected by the war, and although flax had risen substantially in price it had not reached anything like its present high level. Nor was there any indication of an acute world shortage of flax such as is now apparent.

In the note referred to it was shown that several years' experiments at the Cawnpore Experimental Farm had proved that flax could be successfully grown in the canal-irrigated tracts of the U. P. On the basis of the Dooriah factory¹ experiments, with flax at about £60 per ton and with a fibre percentage of 8 per cent., Mr. Vandekerkhove estimated that a central factory could afford to pay R. 1 per maund (82.3 lb.) of rippled straw to growers. At Cawnpore the percentage of good fibre to straw was 10 to 12, and on this basis, prior to the war, U. P. flax was worth at least R. 1.4 per maund.

It was shown that yields of 40 maunds per acre of rippled straw could be obtained without difficulty, given irrigation, and that in a favourable year 60 maunds might be expected. On this basis and assuming pre-war prices for wheat and similar crops, flax,

¹ *Pusa Bulletin* No. 30.

when due allowance was made for the value of the seed, was worth as much as an average crop of wheat at even R. 1 per maund for straw.

Conditions have now materially altered; the prices of wheat and other food grains have advanced materially and, although there was a temporary fall at the last harvest, it seems not unlikely that future calculations must be based on five rupees per maund for wheat and at least eight annas per maund for straw (*bhusa*) except in villages remote from the larger markets. With the higher yielding Pusa wheats, now established over very considerable areas in the neighbourhood of Cawnpore, yields of 20 maunds per acre of grain and approximately 40 maunds of straw are being regularly obtained by a large number of wheat-growers, and with good cultivation substantially higher yields are not uncommon. Flax as a canal-irrigated crop would come into direct competition with wheat from the grower's point of view, and an acre of flax would therefore need to yield at least Rs. 140 to equal wheat. Allowing for the somewhat increased labour required for pulling and handling, and for the fact that no grower would abandon a food crop for a purely commercial crop unless he saw considerable profit in doing so, it is clear that flax would no longer be a profitable crop at R. 1 per maund of straw.

On the other hand, the present price of even medium quality flax is in the neighbourhood of £300 per ton, and it seems unlikely that within the next few years it will be less than £150 per ton. A central factory could, therefore, afford to pay some Rs. 5 to Rs. 6 per maund for rippled straw for a number of years. This would give the grower some Rs. 200 to Rs. 240 per acre for his straw in an average year.

The value of a flax crop at the present time is materially enhanced by the price of the seed, since seed imported from England costs at least Rs. 40 per maund. On the other hand, if the seed is not so handled as to be fit for sale for fibre growing its value will be slightly less than that of ordinary linseed, say, Rs. 8 per maund.

Although flax can be successfully grown in the U. P. it cannot be too clearly stated that there is not the slightest chance of

flax-growing developing as a purely village industry. The retting and scutching of flax require an amount of care and attention impossible in the average village. Nor is the average cultivator in a position to finance a crop of this kind, the seed for which would cost some Rs. 60 per acre, unless he has a definite guarantee of a purchaser for his straw. Given a central factory for retting and scutching, there would be little difficulty in persuading cultivators to grow flax. Without a central factory no progress is possible.

In addition to purchasing straw for cash it would also probably be necessary for the central factory to finance growers to a certain extent, particularly by supplying seed on credit. In view of the present marked discrepancy between the price of flax seed and ordinary linseed it would be desirable for the central factory to make its own arrangements for rippling and to purchase the seed on the straw. Working on these lines advances in kind could be safely made and the central factory would automatically obtain a supply of seed for the extension of its operations since the surplus seed could be purchased from the cultivator at a reasonable price.

Flax when grown at Cawnpore appears to degenerate gradually if constantly grown from local seed. This was very clearly shown by experience at Cawnpore with flax obtained originally from Holland, which had been acclimatized in Bihar for one year. For about three years flax of good quality was obtained, after that degeneration was fairly rapid and the fibre obtained was too short for anything but the coarsest spinning. Hence any business concern taking up flax would have to face the necessity of importing a certain proportion of its seed annually.

RECENT EXPERIMENTS.

In October 1919 English flax seed (Dutch Child) was obtained from the Ministry of Agriculture (Flax Production Branch) and also a small supply of Japanese seed from the Flax Control Board. The latter was believed to be of Dutch origin but its parentage is not known. Both these varieties grew well at Cawnpore. Full figures are not yet available as the bulk of the crop has been retained for retting and scutching during the coming cold weather in accordance

with previous practice. The yield of straw per acre was lower than usual—Japanese flax 42 maunds per acre, English flax (Dutch Child) 35 maunds per acre—on account of an unusual shortage of canal water (such as has not been recorded at Cawnpore for some 8 years) which prevented adequate irrigation being given. The seed yields were $5\frac{1}{2}$ maunds per acre for English flax and 7 maunds per acre for Japanese flax. On a preliminary trial the fibre percentage was 17, which is unusually high, but this figure requires confirmation under normal conditions. The crop grew well and the length of the fibre was satisfactory.

Throughout the Dooriah flax experiments retting and scutching was postponed until the beginning of the cold weather following the harvesting of the straw. This involves the locking up of capital for a period of six months and, under present market conditions, the central factory would also have to take the risk of very considerable market fluctuations. Though possibly not a disadvantage at present this might be sufficient to cause material loss when flax production in other countries recovers. Experiments were, therefore, carried out to see whether retting and scutching could be performed in April immediately after the flax harvest. The high temperatures caused less difficulty than was expected in retting. Scutching was difficult on account of the intense dryness of the air and could only be carried on in a closed room artificially kept damp. During the monsoon retting would be impracticable, but scutching appears to present no particular difficulty. Until valuations are received of flax retted and scutched in April and flax from the same crop retted and scutched in October-November it is not possible to say how far hot weather retting is feasible, but the point is obviously of considerable importance.

SOME OBSERVATIONS ON THE ROOTS OF FRUIT TREES.

BY

W. BURNS, D. Sc.,

Economic Botanist, Bombay ;

AND

L. B. KULKARNI, L. Ag.,

Of the Bombay Agricultural Department.

THE following observations were made on the roots of *Citrus* trees in two places, and on the roots of guava trees in one place.

CITRUS.

The Vernacular Agricultural School at Loni, near Poona, had a fruit plot which was not entirely satisfactory, being planted to a number of varieties of fruit trees some of which grew indifferently. It was decided to take out all these trees and replant with one variety. Opportunity was taken to expose fully the root system of a typical orange tree of the loose skinned type (*Santra*) and also the root system of a typical orange tree of the tight skinned type (*Mosambi* or sweet lime). The following history of the plants is of interest. There was one line of each. Both were budded on the *Jamburi* stock, a variety of *Citrus medica*. The soil was alluvial loam, varying in depth from 1 to 2½ feet, with hard trap just underneath. The surface slope was about 5 degrees (estimated) running down to a *nulla*. The trees were planted in November 1914, and so were nearly five years old when the roots were exposed in October 1919.



Fig. 1. *Santra* tree at Loni, showing spread of lateral roots.

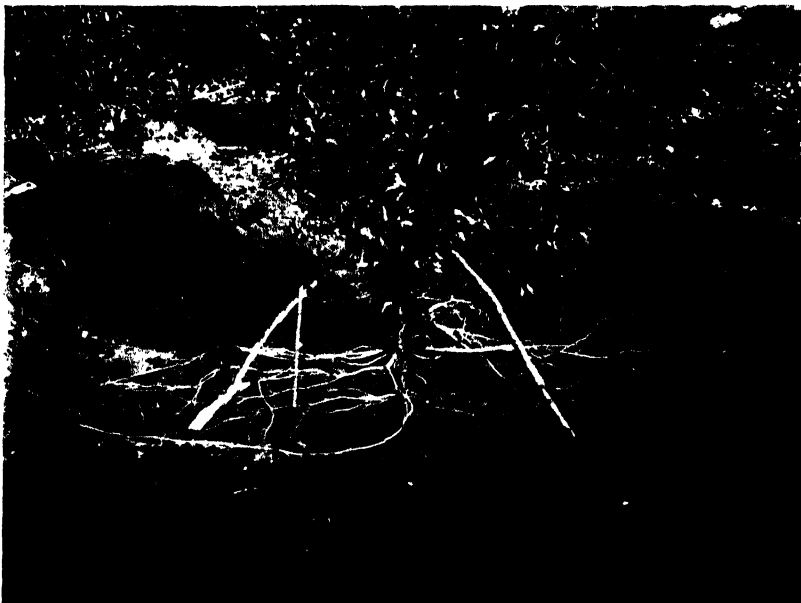
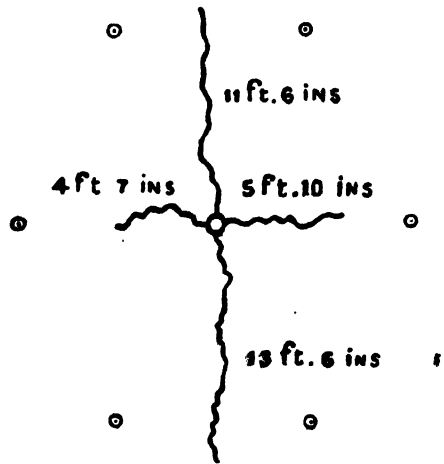

Fig. 2. *Mosambi* tree at Loni, showing spread of lateral roots.

For two years after planting the plants were irrigated in basins up to the stem. These basins were of a radius of 3 feet. Thereafter ring irrigation was practised, the ring being widened yearly. The rings were cultivated by hand after each irrigation. General cultivation with a disc harrow was given once a month, and the soil was ploughed thrice a year to 5 inches deep.

Water was given not at fixed intervals, but when the trees showed signs of needing it. The minimum interval was 10 days, the maximum 20, and the average 15 days. No root exposure was practised, and the trees flowered without any forcing. All did not flower at the same time, but the majority flowered in June. No inter-crop was taken after May 1917. The inter-crop previous to that date, if any, is unknown.

While exposing the roots, one interesting physiological fact came to light. Exposure of the roots was begun on October 9. On October 11, the horizontal spread of the roots was entirely exposed. The plants remained thus without wilting till October 13, when they were examined. During this period the average day maximum temperature was 93° F. and no water was given. The plants' resistance to drought, with only a few roots left as absorbing organs, is therefore remarkable.



Text-fig. 1

Plate XXXV, fig. 1, represents the *Santra* tree, and Plate XXXV, fig. 2, the *Mosambi* tree.

The following points are noticeable:—

- (1) The relatively great spread of the root system. The height of the *Santra* plant was 10 feet 4 inches from the soil level.

The root lengths laterally varied up to 13 feet 6 inches, with an average of 8 feet. It will be seen from the plan (Text-fig. 1) that the greatest length of roots occurred on the side where, in the quincunx arrangement of the

trees, there was a way for them to get between the trees in the next row.

The *Mosambi* tree had a height of 7 feet 4 inches, and a trunk diameter at soil level of 4 inches, which diminished to $1\frac{1}{2}$ inches at 18 inches below the surface (presumably the tap root). The average radius of the root circle was 6 feet 10 inches.

- (2) The next point of interest and importance is the comparative shallowness of the lateral roots. These, in both cases, started from 6 to 12 inches below the soil level and then spread out, branching and gradually rising in the soil. All these terminated in small richly-branched masses of feeding roots. Besides these lateral roots there were two or three roots of from one to half-an-inch diameter going deeper into the soil and apparently acting as anchoring roots. These, of course, could go no further when they came up against the hard trap underlying the soil.

Plate XXXVI, fig. 1, shows a 14-year old *Santra* plant, also budded on *Jamburi*, growing in deep medium black soil in the Ganeshkhind Garden, Poona. The root system is here of precisely the same character. There are well developed lateral roots growing in all directions to an average radius of 10 feet, several roots being as far out as 16 feet, the mean point of origin of these laterals being about 9 inches below the soil surface. The anchoring roots were more strong and thick, but not numerous. This plant was suffering badly from die-back and many of the roots showed rotting, apparently unaccompanied by fungus or insect attack. This tree had had its roots exposed yearly to check its growth and the roots near the trunk were all scarred and injured by the implements used, partial healing having taken place. Plate XXXVI, fig. 2, shows another tree in the same line in the last stage of die-back with all roots so rotten that few remained to be photographed. It is exceedingly likely that this was due to the waterlogging of this heavy soil. Balls¹ records something similar for the cotton plant. He states:—

¹ Balls, W. L. "The Cotton Plant in Egypt," 1912, p. 38.



Fig. 1. *Santra* orange tree, budded on *Jamburi*, in Ganeshkhind Garden. Planted in August 1905; photographed on 6th December 1919. Plant suffering from die-back.



Fig. 2. *Santra* orange tree, at Ganeshkhind Garden. Planted in August 1905; photographed on 6th December 1919. Plant dead from die-back.

"Lastly we have to consider an abnormal limiting factor of root growth, namely, deficiency of soil oxygen, usually due to water-logging of the minute interstices which the soil contains. Owing to the fact that its anatomical structure does not include an elaborate system of intercellular air-spaces, such as aquatic plants possess, the cotton root is locally asphyxiated in waterlogged soil, and in a few weeks even the stout, woody roots are not merely dead but decomposed."

The indigo plant, as we now know, suffers similarly from the destruction of the fine roots in the rains.

The method of irrigation for the past ten years, at least of these trees, had been in basins of 6 feet square. Cultivation had been by hand in the basins and an occasional ploughing and harrowing between the lines. The distance apart of the trees was 16 feet and of the lines was 20 feet.

From the above examples and various other observations we come to the conclusion that the *Jamburi* stock, universally used for oranges in the west of India, is a surface-rooting stock with a fair spread of lateral roots, but few deeply penetrating roots. That the depth of the root system in *Citrus* stocks is largely a specific character independent of the environment has been shown in America. A specially good account of this phenomenon with photographs and drawings is given by J. W. Mills¹ in comparing the root systems of what he calls Sweet-oranges, Pomelo and Florida Sour-orange. It is impossible without herbarium specimens to correlate these with any of our Indian species, but the facts show, for example, that the Sweet-orange is shallow rooting in all conditions. If this be so with our *Jamburi* also, then certain practical points immediately need attention. To begin with, it is obviously quite possible to grow plants on this stock on a soil of only 3 feet deep, if the soil is well drained. Second, cultivation should never be deep once the plants have been established, a maximum of 5 or 6 inches being all that is permissible, and less than that desirable. Third, water should be given all over the plantation after the fifth year, for

¹ Mills, J. W. "Citrus Fruit Culture," 1902, pp. 10—19.

the roots are there. It may be desirable to irrigate different parts of the soil between the trees in successive years to avoid formation of a pan or to arrange for ventilation of the soil, but the water should be distributed all over the ground and not localized. Fourth, manurial experiments conducted with different manures on adjacent lines of trees are worse than useless, as feeding roots from one tree enter the next line and any conclusions drawn will be false.

GUAVAS.

The observations on guava roots are of a somewhat different character. In the year 1915, a piece of very poor ground, having from 2 to 20 inches thickness of soil and underlying it a thin layer of *murum* (disintegrated trap), and then very hard trap, was blasted to give pits in which to plant guava trees. It was hoped that the shattering of the rock would allow this plant of well-known hardy character to penetrate the crevices and so grow.

Seedling guava trees were planted in these pits in September 1915.

The roots of three were exposed in the last week of November 1919 to see what growth had been made. Plate XXXVII shows a typical case. This is plant No. 14. Text-fig. 2 is a drawing showing the root of the said plant to its utmost depth.

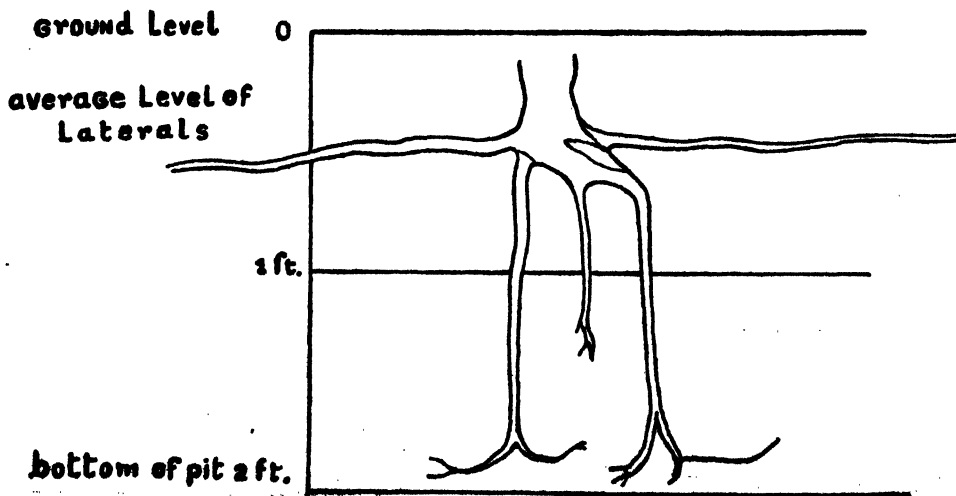

Text-fig. 2.



Guava planted in blasted pit. Date of blasting, 12th July 1915. Date of planting, September 1915.
Plant No. 14, variety Allahabad. Date of photo, December 1919.

The points of importance are: the plants flourished, grew and developed normally. They seemed to suffer a little in the hot weather but soon picked up in the rains. As an example of their hardihood, we may take their behaviour when their roots were completely exposed for the purpose of the present investigation. The roots were open for 10 days. The plants completely dropped their leaves and appeared to be dead. After 8 days, however, the plants put forth new buds and are now (February 1920) in full leaf again. The root exposure was in the last week of November 1919.

Second, careful study of the roots showed that the roots had actually penetrated the rock crevices between the shattered slabs as we had hoped, and had even made distinct indentations on the softer rock. The shattered rock was gradually disintegrating under the influence of soil, water, and roots.

The average lateral spread of the roots was 7 feet 2 inches and these laterals came off about 7 inches below the surface of the soil. When the vertically descending roots met the underlying rock, or when laterally growing roots met the impenetrable, undisintegrated, unshattered trap, they bent back and went on growing till again held up, much like a root in a pot. In the surface soil, however, there was free scope for root growth.

We may, therefore, generalise and say that in soil of 1 foot deep guavas may be successfully cultivated if the pits are very thoroughly blasted to a depth of 3 feet. The blasting material used was gelignite, in varying amounts, with a primer of dynamite. The cost was six pies per cubic foot.

For trees planted in such conditions, the following points require attention:—

- (1) Water must necessarily be easily available and watering must be regular and at shorter intervals than to plants in normal soil, especially when the plants are in bearing; otherwise the slightest shortage of water makes flowers and fruits wither. Plantations receiving canal water only are not advised, as the water supply may be irregular.
- (2) Root exposure for the forcing of flowers is unnecessary since the plants are easily dried off.

- (3) Pruning of shoots for fruits is not advisable as shoots are short, and there may occur undue exposure of the inner parts of the tree by pruning.
- (4) Since ripe fruits do not keep long on the trees, there should always be a ready market for these fruits.
- (5) With a good supply of water and manure, it is possible to get two crops a year as the period of bearing is shorter than usual. A plant which has borne flowers in June finishes its harvest in November and again bears in January and the harvest finishes in June.
- (6) The actual number of fruits produced per tree has, however, been unsatisfactory, averaging only 25. It is probable that special manuring will overcome this defect.

THE AMERICAN BLIGHT" OR "THE WOOLLY
APHIS," *ERIOSOMA (SCHIZONEURA)*
LANIGERA, HAUSMANN.

BY

C. S. MISRA, B.A.,

First Assistant to the Imperial Entomologist.

THIS Aphid is known as the "Woolly Aphid" or the "American Blight" and is a very serious pest of the apple. It is known in all the apple-growing tracts of the world and a considerable amount of work has been done on it in England, America, Australia, New Zealand and South Africa. The insect is American in origin and was first introduced into England in 1787 and has ever since been on the increase. It was first noticed in India by the late Mr. Atkinson in 1889 when he wrote that the Woolly Aphid "had destroyed nearly every orchard in Coonoor." Ever since that time fresh localities seem to have become affected and are likely to become so if no precautions are taken now to circumvent the ravages of the worst pest of the apple. It must be borne in mind that if the pest once becomes well established in a locality or localities it is not easy to eradicate it. It has existed to a most alarming extent all through Kumaon, as the following extract from a letter of Lt.-Col. Molesworth, Proprietor of the Binsar Estate, Almora District, April 1910, will show:—".... There is no doubt that very vigorous measures are necessary or the days of apple culture at least are numbered in this district. At Almora it has existed for many years. The gradual destruction of all fruit trees is very evident. It not only affects the well-grown trees, but is almost invariably found on young saplings and trees before they begin to bear. Hence the trees are diseased from the very beginning, and can never be expected to flourish. It attacks

the roots as well as the branches and is the most destructive form of plant disease that can possibly attack trees. Young orchards that may be started in Kumaon cannot possibly flourish until we know how to stamp out the American Blight. It has been stamped out in Italy, and until similar measures are taken here, it is perfectly useless to try and start a fruit industry."

I can personally bear testimony to the above. In 1917, when I was on privilege leave, I had occasions to examine the apple orchards in the Almora District and there it was impossible to find a tree that was free from the pest. The people generally used to bring branches for my examination, but it was useless to suggest remedial measures for a pest that was present underground on the roots of almost all the apple trees in the locality. The people could never be induced to believe that the cause of the death of their apple trees was an insect that was present on the roots of trees underground. That the pest is bad in the vicinity of Simla is evident from an extract of a letter from Lt.-Col. Bernard Scott, dated the 12th October, 1910 :—".....We have here (Kodiali Estate, District Simla) about 1,000 young fruit trees, mostly apples, ranging from 2 to 7 years. Last year some of the apples were attacked by a disease which we take to be Woolly Aphis, introduced we think with a consignment of young trees from England. The varieties of apple we grow are: Devonshire Quarrenden (badly attacked), Worcester Pearmain (badly attacked), King of the Pippins (very slightly attacked), Sturmer Pippin (very slightly attacked), Lady Ludeley, Allan's Everlasting and Cox's Orange Pippin (free). Those trees which are attacked swell at the diseased points into knotty lumps, mostly near the collar, the wounds after healing generally throwing out short aerial roots....."

Last year during October, Major H. R. Wigram, Secretary, Kashmir State Game Preservation Department, wrote:—" I am sending you some apple twigs (Plate XXXVIII) attacked by a white, frothy parasite named by Mon. Pechaad as the 'Woolly Aphis.' It was imported from China some years ago and is now becoming a perfect pest in Kashmir. The only way to save a garden is to cut out and burn every tree that is attacked. This course has been adopted and

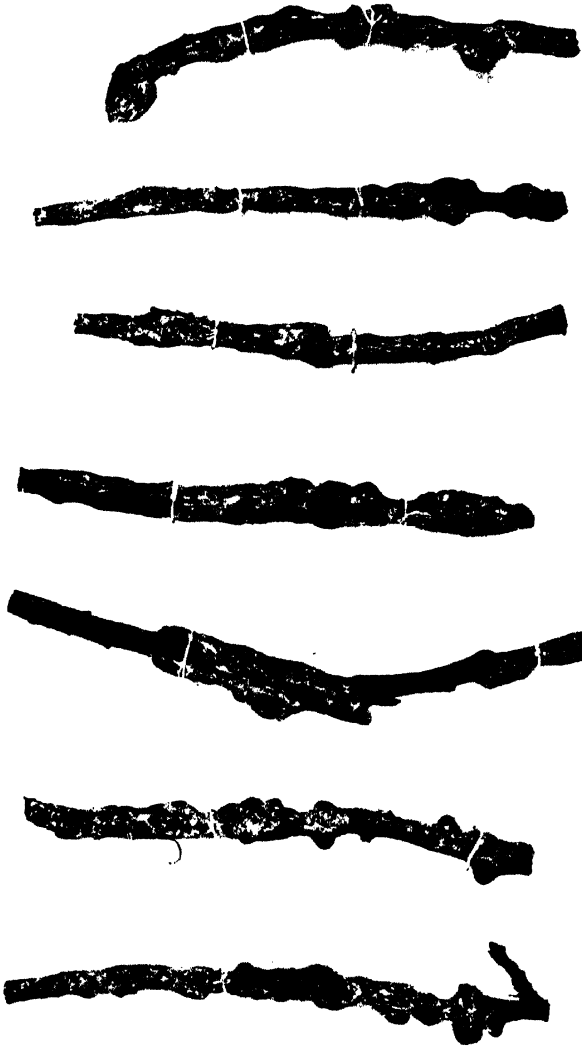

AFFECTED APPLE TWIGS FROM KASHMIR (original).



Fig. 2. Affected apple roots and stem Kulu, Punjab (original).

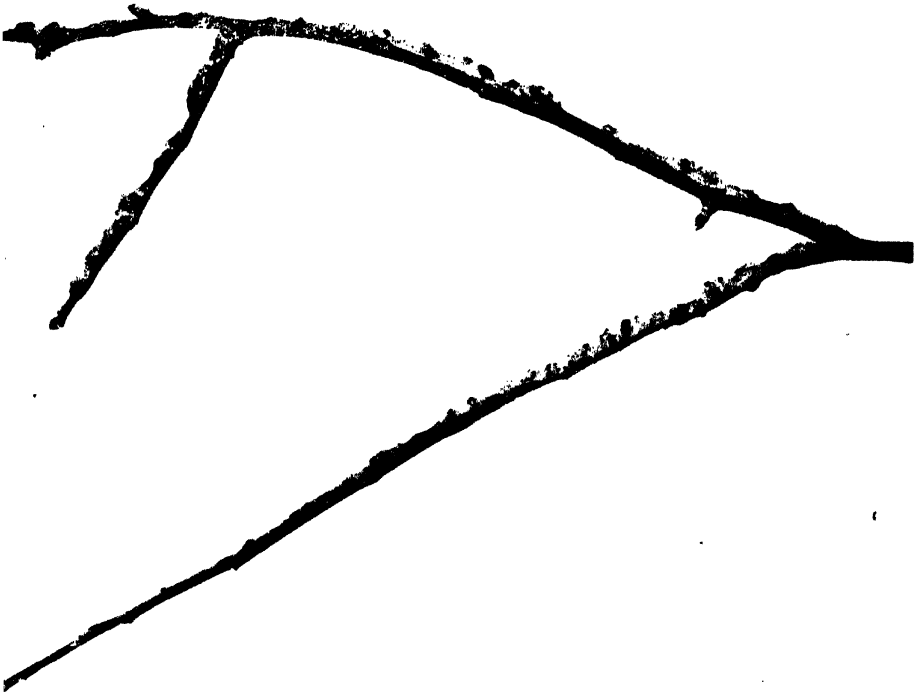

Fig. 1. An affected apple-stem from Lachung (Gangtok-Sikkim) (original).

thousands of trees in the garden of the Maharaja, as well as the State gardens, have been destroyed. I cannot believe that there is no cure, and as I am most unwilling to sacrifice valuable trees, I am writing to you for advice. If it means death to the trees, it is, I consider, a very serious matter as the disease may spread throughout India, with disastrous results. It only attacks apple trees as far as we can see, and only some kinds."

A month after, further specimens were received from the Forest Ranger, Sikkim State, Gangtok, from the apple orchard at Lachung (Sikkim). The stems of stocks (Plate XXXIX, fig. 1) as well as the stems of grafted trees were very badly attacked by the Woolly Aphis, and it was doubtful if the trees could survive long the attack of the pest. The roots of trees were malformed into hard convoluted enlargements and could scarcely be expected to perform their normal function. The same was found to be the case with specimens received from Kulu in the Punjab (Plate XXXIX, fig. 2).

The Woolly Aphis is widely distributed, and is present in England, France, Belgium, Germany, Italy, Transcaucasia, the United States of America, Mexico, Chile, Canada, South Africa, the Transvaal, Australia, New Zealand, Tasmania, China, Japan and India. It is known as the "American Blight," the "woolly blight," the "woolly plantlouse," the "woolly apple-louse," the "apple blight," the "woolly louse," the "apple tree root-louse," the "woolly louse of the apple" and the "blood-louse." In France it is generally called "Puceron lanigère," and in Germany is known as "Bluttlous." In India it is bad in the Himalayas, especially Kumaon and the Nilgiris. It is known to occur at the following places*:

Jalna

Kali

Muktesar

Ranikhet

Chaubattia

Binsar estate

Kumaon, U. P.

* Noted from records available in the Entomological Section, Agricultural Research Institute, Pusa.

Bandrole, Kulu, Punjab.

Kodiali estate, Simla, Punjab.

Bangalore

Coonoor

Ootacamund

} South India.

Taung-gyi, Southern Shan States, Burma.

Lachung, Gangtok, Sikkim.

The Woolly Aphis is not only destructive to young stock, but old trees do not escape from it. The young as well as the adults suck out the sap constantly and thus lessen the vitality of the tree. They puncture the young wood and cause abnormal growths of soft tissues which form rounded swellings which split later on and form rugose deformities so characteristic of the presence of the Woolly Aphis (Plate XL). Such deformities are sometimes mistaken for the canker. They also damage the roots and form gall-like swellings which do not split. The effect of the presence of the Aphis on the stems as well as the roots is that the plant is unable to withstand the drain and dies prematurely. Those that survive become stunted in growth and produce only scanty and poor quality of fruit. In some places it has been proved that an attack of the Woolly Aphis predisposes the plant to the attacks of the canker.

There are two forms of the Aphid, the one attacking the roots, detected by the knotty appearance of the infested roots (Plate XXXIX, fig. 2), and the other attacking the limbs and the trunk. The aerial form is very prominent and is detected easily by the presence of whitish flocculent patches on the stems (Plate XLI.)

The subterranean form is not so easy to detect unless the roots are opened out and examined. But generally the presence of the aerial form on the branches is an index of the presence of the underground form on the roots of the plant.

The Woolly Aphis was known to attack the apple only, but now it has been proved conclusively in America¹ that the elm is the primary host of the species. If, therefore, there are any elms in the

¹ Baker, A. C. "The Woolly Aphis." *Rept. No. 101, U.S. Dept. of Agri. Bureau of Entomology, 1915.*



AFFECTED APPLE BRANCHES FROM LACHUNG (GANGTOK SIKKIM) (original).



WOOLLY APHIS ON BRANCH OF YOUNG APPLE.
(After Washburn.)

immediate neighbourhood of apple orchards, a sharp look-out should be kept, and if any patches of flocculent whitish stuff are found on them, they should be treated promptly and simultaneously with those on the apple. Considerable work has already been done in America and elsewhere and it is presumed that the details of life-history, etc., though they have not been worked out in detail here, will stand good in the case of this country also with certain modifications, though it has been found in France that the Aphid has altered its habits since its importation about 100 years ago.

Those who wish to know the life-history in detail should consult the latest works¹ on the pest, and I think the readers of the Journal will greatly benefit themselves if they were to read what has been effected in Australia and South Africa with the introduction of blight-resistant stocks.

There is no doubt that the pest was introduced into this country on stocks imported from abroad and this points to the danger of importing varieties of fruit trees and flowers without proper examination and treatment at the port of disembarkation. The passing of the Destructive Insects and Pests Act of 1914 precludes the possibilities of such introductions now, but there is no measure by which seedlings or grafts from affected localities could be prevented from entering into localities which have hitherto remained immune. With demobilization and the end of the last great war, many people in North India are actively thinking of taking to fruit culture in the Himalayas, especially in Kulu and Kumaon, and such people should desist from obtaining their stocks or grafts from affected localities or else they will be put to considerable expense and loss in course of time.

¹ Marchal, P. "Le cycle évolutif du Puceron lanigère du Pommier *Erio. lanigerum*." *Hans. C. R. hebdom. Acad. Sci., Paris*, CLXIX, No. 5, 4th Aug. 1919, pp. 211-216. *Rev. App. Ento.*, VII, A, 10, p. 432, Oct. 1919.

Baker, A. C. "The Woolly Aphis." *Rept. No. 101, U. S. Dept. Agri. Bureau of Entomology*, 1915.

Theobald, F. V. "Insect Pests of Fruit," pp. 141—153, 1909.

Monthly Bull. Cal. State Commiss. Hortic. Sacramento, Vol. VI, Nos. 11-12, Nov. and Dec. 1917.

My main object in writing this short note has been to draw the attention of such would-be fruit-growers and they would do well to follow the brief recommendations made herein. For more detailed information they should consult the latest work done on the pest in England, America, Australia and South Africa. Of the two forms of the Aphid, that which lives on the roots of apple trees is the most difficult to deal with, but with experiment and observation the ravages of the subterranean form have been considerably lessened or altogether eliminated by grafting the selected but susceptible varieties on such resistant varieties of apple as the Majetin and the Northern Spy. The usual method in South Africa is first to graft a slip of resistant branch on to a resistant root and later to graft on this stock the particular variety of apple desired to propagate. To further the work of the establishment and selection of resistant stocks, observations from a number of places and on a number of varieties are required, and if the readers of this Journal will keep a record of their observations, as was done by Lt.-Col. Bernard Scott (*vide* his letter quoted above), considerable information will accumulate which will be of great use to prospective apple-growers in different parts of the country. They should particularly avoid planting affected stock which should be obtained from reliable nurserymen only. If, however, there are any doubts, the roots of plants should be opened and examined. If they are twisted, malformed or swollen, there is every reason to suspect that they are affected and as such should be condemned and burned. If, however, the affection is slight they should be thoroughly treated with kerosine emulsion or hot water before being planted out permanently in the orchard. Old and badly infested trees should be completely dug out and burned, and the space utilized for other crops for a series of years. If this is not done soon, there is every possibility of other trees becoming affected, and the whole orchard becoming, in course of time, a hotbed for the propagation of the pest and a source of danger to the adjoining apple orchards.

The aerial form is easily detected by the presence of bluish-white flocculent patches on the stems as seen in Plate XLI. This form can be easily controlled by spraying the infested trees with any of

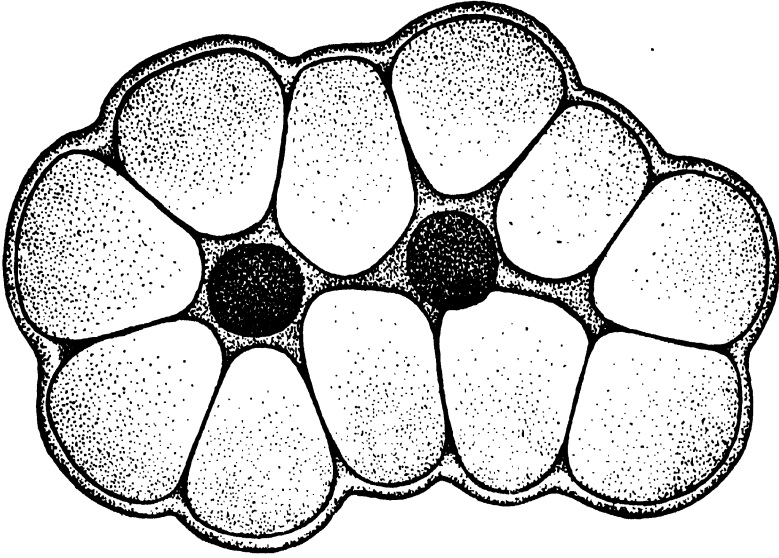

z

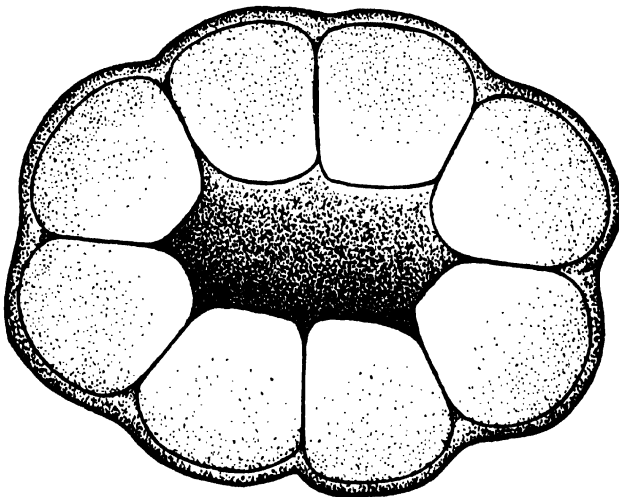

a

Wax pores on the body of the Woolly Aphis, wingless viviparous form.

a. Dorso-thoracic wax pore, much enlarged.

b. Dorso-abdominal wax pore, much enlarged (original.)

the contact insecticides, crude oil emulsion, kerosine emulsion, or fishoil resin soap. The flocculent bluish-white secretion which covers the bodies of nymphs, as well as the adults, is secreted from wax pores* interspersed on the body of the Aphid and possibly acts as a good insulator against inclemencies of weather and the dampness of the earth, especially in the case of the underground forms (Plate XLII). In order that the contact spray-fluid should come in immediate contact with the bodies of the Woolly Aphis, it is necessary that the spraying should be done persistently and with a force-pump provided with an air-chamber, so as to remove the bloom surrounding the bodies of the Aphid. To do this satisfactorily, an extra quantity of spray fluid should be used, and at frequent intervals, until no trace of the pest is left on the trees. The extra expenditure thus incurred will be more than counterbalanced by the good results obtained later on.

The use of tobacco has had a marked success in dealing with this serious pest. The tobacco destroys the Aphids by leaching through the soil and acts as a bar for a year or so to reinfestation. The dust is a waste product of tobacco factories and possesses the additional value of being fully worth its cost as a fertilizer.¹ In one of the latest works on the pest it is stated²:—"It was found that Black leaf 40, 1 part to 1,000 parts of water, poured into the soil around the roots practically freed the trees from the root-infesting form. The experiment was then tried of planting a plot with tobacco, the refuse from this growth being chopped up and placed in trenches around the fruit trees, 5 lb. being used for each tree. This was first applied in November and the rest towards the end of February; the second application seemed to be the most successful and an orchard badly attacked by *Eriosoma lanigerum* is now entirely free from infestation.....Though this treatment of

* Specimens treated with ammonia-ferrie-sulphate, stained with Delafield's hæmatoxylin, counterstained with eosin in absolute alcohol, cleared in cedarwood oil and mounted in Xylol Balsam.

¹ Circular No. 20, Revised edition, U. S. Dept. Agri. Bur. Entom., June 1908.

² "Rept. of County Hort. Commiss." *Monthly Bull. Cal. State Commiss. Hortic. Sacramento*, Vol. VI, Nos. 11 and 12, pp. 415-482, Nov. and Dec. 1917. *Rev. of Applied Entom.*, Vol. VI, A, 13, pp. 797-98, March 1918.

root-infesting forms of Aphids is still in the experimental stage, it is considered worthy of recommendation to growers.”

If these preventive and remedial measures are adopted, it is hoped that the ravages of the pest will be minimized and circumscribed considerably. It will no longer lay a heavy toll on the yearly produce, and the main impediment to the extension of the budding apple industry in the Northern Himalayas will be removed completely. With the extended use of blight-resistant stocks, the dreaded pest will be brought within such control that, what Mr. French, the Government Entomologist of Victoria, wrote in 1904 will hold good more or less in this country also. He said¹:—“Before the advent of these excellent blight-resisting stocks, the Majetin and the Northern Spy, it was exceedingly difficult to find in most orchards an apple tree that was clean or in perfect health. Now, with a little care and attention, the fruit-grower, as a rule, may snap his fingers at the American-blight”

[*Note.* To the list of localities given by Mr. Misra as infected with this Aphid, may be added Shillong and Ramgarh (Kumaon District). Probably all apple-growing districts in India and Burma have been infected by means of the importation of diseased stock. As regards control, (1) in the case of newly imported stock, whether received from anywhere in or outside of India, it should be examined very carefully on receipt and before planting and, if there is the least sign of infection, the plants should be wiped over with an insecticide such as methylated spirits (used successfully in the Government Fruit Garden at Shillong); if the trees are badly infected, the best thing to do is to burn them forthwith. (2) In the case of orchards which are already infected, every endeavour should be made to keep the pest within control, by attacking it immediately it is seen and not allowing it to spread. If trees appear sickly without obvious cause, the presence of this Aphid may be suspected and the roots should be opened up and, if the

¹ French, C. “Destructive Insects of Victoria,” Vol. I, p. 37, 1904.

Aphid is present, treated with a contact insecticide, and a good quantity of waste tobacco be placed around the roots. The aerial forms, living on the trunk and branches of the trees, should be treated with a contact spray or wash, thorough treatment being essential. Special endeavours should be made to check this pest at the time when the winged adults appear, in order to prevent these from spreading infection throughout the orchard. At Ramgarh I noticed the winged adults present about the third week of August 1918 and probably this date will hold good, approximately at least, throughout the Himalayan Region.—T. BAINBRIGGE FLETCHER, Imperial Entomologist.]

A PRELIMINARY NOTE ON THE EFFECT OF
WATERINGS ON THE AMOUNT OF ACIDS
SECRETED BY THE GRAMPLANT
(*CICER ARIETINUM*).*

BY

D. L. SAHASRABUDDHE, L.AG., B.Sc.,
Assistant Professor of Chemistry, Agricultural College, Poona.

INTRODUCTORY.

It has long been known that the gram plant secretes and deposits an acid liquid all over its surface. This peculiar acid secretion was studied in some of its aspects by me some years ago and the results of that study were published in *Bulletin No. 45 of the Agricultural Research Institute, Pusa*, in 1914. The following conclusions were arrived at:—

- (1) The whole gram plant is covered with two kinds of hairs—simple and glandular. The glandular hairs with knobs are found in large proportion on the ovaries and the pods and the amount of acid produced by the parts covered with glandular hairs is far greater than the amount produced by the other parts of the plant.
- (2) When the plant is two weeks old, it is covered with the acid liquid equivalent to about 0.36 gramme of caustic potash per hundred grammes of dry matter of the plant and the acidity goes on increasing up to 3 or even 3.5 grammes of caustic potash when the pods are well developed but decreases when the plants begin to ripen.

* Paper read at the Seventh Indian Science Congress, Nagpur, 1920.

- (3) The acids in the liquid consist of malic acid 90 to 96 per cent., oxalic acid 4 to 9 per cent., and volatile acids 0.1 to 0.5 per cent.
- (4) The plant is continually producing acid and if the plant is washed with water the usual acidity is recovered in about a week.
- (5) Lastly, about 2,000 grammes of malic acid could be collected from one acre of gram crop.

It was subsequently proposed to find out the effect of waterings and manures on the quantity of acid produced, and the following are the results arrived at from the pot experiments carried out at Poona.

THE EFFECT OF WATERINGS.

The experiments were carried out in glazed pots buried in the ground, the surface area of the soil in pots being 1.39 square feet. Soil sufficient to fill all the necessary pots was collected together and properly mixed in order to make it uniform for the pots. The pots were filled with the mixed soil with a gentle pressure and watered with one gallon of water per pot. The seed was sown when the moisture condition of the soil was favourable for sowing.* The seed was carefully selected to keep uniformity. There were in all 18 pots used. They were in six rows of three pots each and in each pot three seeds were sown on 23rd October, 1914. The seeds germinated on the 2nd of November and the waterings were started from that date, each watering being equal to 1,000 c. c. of water.†

The pots in the first row were watered every day, in the second row twice a week, in the third row once in a week, in the fourth row once in two weeks, in the fifth row once in four weeks, and in the sixth row the pots were never watered after the seed was sown. Out of three plants in each pot the weakest was removed and only two plants were kept so that for each experiment there were six plants available. The acidity was determined by pulling out the plants,

* 22 per cent. moisture.

† About $\frac{1}{2}$ inch of rainfall.

washing them completely with distilled water and titrating against $\frac{N}{10}$ caustic potash. The dry matter of the plant was also determined and the acidity expressed in terms of grammes of caustic potash. The acidity was determined when the pods were fully formed. It was proved in the *Pusa Bulletin* No. 45 that the highest amount of the acids was secreted when the pods were fully formed and hence the results of the determinations at this stage are important.

It might with advantage be mentioned here that the first row of pots received 64 waterings from the time of germination to the time when the pods were fully formed; the second row received 22 waterings, the third 10 waterings, the fourth 5 waterings, the fifth 3 and the sixth no watering after germination of the seed. The plants in the first row took longer to develop fully the pods. All the other plants had their pods fully developed between the 8th and the 15th of January, 1915, while the plants in the first row came to the same stage on the 12th of February. The following table gives the dry matter per plant and acidity per 100 grammes of dry matter in grammes of caustic potash.

TABLE I.

Dry matter and acidity at the time when the pods on the plants are fully developed.

	Dry matter per plant grammes	Acidity per 100 grammes of dry matter in grammes of caustic potash
1. Watered every day, 64 waterings ..	29.0	0.93
2. Watered twice a week, 22 waterings ..	14.8	1.60
3. Watered once a week, 10 waterings ..	9.6	1.86
4. Watered once in two weeks, 5 waterings ..	7.5	1.98
5. Watered once in four weeks, 3 waterings ..	10.2	2.15
6. Not watered	4.5	2.52

The first column shows that except in No. 5 there is increase in weight of dry matter as the number of waterings increases. In the first four rows of pots there is an increase of 0.38 gramme of dry matter per watering of 1,000 c.c. The figures in the second column show that the acidity per 100 grammes of dry matter decreases as the waterings are increased in number. One peculiarity is that as the

number of waterings increases the fall in acidity becomes smaller. The fall in acidity per cent. as seen between the plants that received 3 waterings and the plants that received 5 waterings is 0.085 gramme of caustic potash per watering of 1,000 c.c., while the fall between the plants that received 5 waterings and the plants that received 10 waterings is 0.024 gramme of caustic potash and so on, as will be clearly seen from the following table:—

TABLE II.

Fall in acidity per 100 grammes of dry matter for every watering of 1,000 c.c.

Plants		Fall in acidity per cent. in grammes of caustic potash
Between plants receiving	22 and 64 waterings	0.016
" "	10 " 22 "	0.022
" "	5 " 10 "	0.024
" "	3 " 5 "	0.085

Although the percentage of acidity decreases with the increase in the number of waterings, the actual quantity of acid secreted by each plant increases, as will be seen from the figures given below:—

TABLE III.

Total acids per plant.

Plants	Average total acids per plant in grammes of caustic potash
Watered 64 times	0.27
" 22 "	0.24
" 10 "	0.18
" 5 "	0.15
" 3 "	0.22
Not watered	0.11

We might, therefore, conclude that when the number of waterings is increased, the dry matter per plant and total acidity per plant are increased, while the percentage of acidity on dry matter is decreased.

MALFORMATION OF THE COTTON PLANT LEADING TO STERILITY.

BY

G. L. KOTTUR, B.AG.,

AND

M. L. PATEL, B.AG.,

Of the Department of Agriculture, Bombay.

IN almost all parts of Western India, with the exception of those growing American types of cotton, there appear occasional malformed cotton plants or parts of plants which either produce no flowers or bolls, or produce a few small bolls only giving light seed with low ginning percentage. The affection is so generally distributed and leads to such an appreciable annual loss that a close study of its nature and character has become essential. So far we can only describe the affection: its cause remains obscure. No parasite, either of animal or vegetable origin, has been noticed, and no means have been discovered for anticipating and checking its development.

The appearance of a malformed plant is very characteristic. Either the whole of the branches of a plant or certain among them only show three characteristic changes, generally commencing when the plants are two to three months old. These changes are as follows. The leaves become smaller and more cleanly cut, and do not possess the usual sinuses, and hence appear crowded together on the stem or the branches. The colour is also abnormal, the leaves being dark green at first, gradually changing to reddish and pinkish yellow as the stage of affection advances. And, again, the plants or branches affected usually die without producing any seed, though occasionally



1
Normal branch and leaf.



2
Malformed branch and leaves.

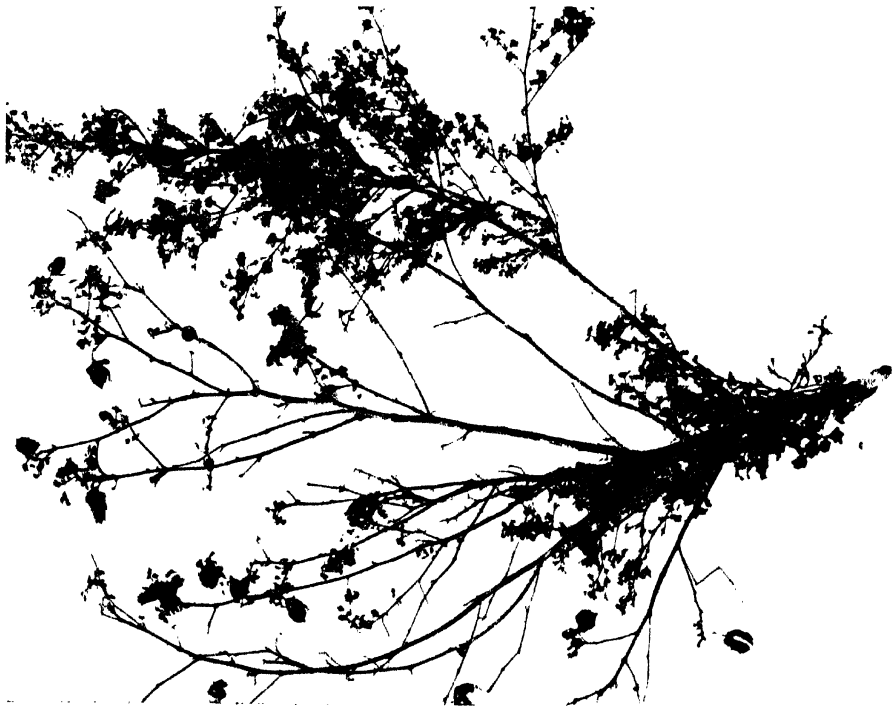

Fig. 1. Second type of malformed plant, one branch completely affected and the remaining branches partially affected, showing the imperfect opening of bolls.



Fig. 2. Third type of malformed plant.

a few normal flowers are produced giving seed. Usually, however, though the cup-shaped calyx of the flower appears, the flower-bud does not develop and remains in a rudimentary condition.

As we have already stated, the whole plant may be affected, with most of the leaves pinkish yellow, bearing no flowers and bolls. Often, however, only one or more branches are affected, and the remaining portion develops normally. The malformed branches may produce small bolls, though most of them dry up rapidly and the few which succeed are often imperfect in opening and give produce of low ginning percentage and light seed. A third type of diseased plant is often noticed, where the whole appears healthy, except that at the base there is a clump of short branches having the malformed diminutive leaves.

The appearance of plants affected with the disease in question is very characteristic. Plate XLIII shows a branch and leaves of such a plant, side by side with a normal cotton branch of the same variety, and when (as has sometimes happened) more than eight per cent. of the plants in a plot are affected the matter becomes of very serious importance.

Among the various types of cotton it may be stated at once that the disease has never been noticed among American or Egyptian varieties. Among indigenous Indian cottons, the *herbaceum* cottons (Broach, Goghari, Kumpta, etc.) are by far the worst affected, but the other types (*neglectum* and *obtusifolium*) also show the affection though to a limited extent. Among the *herbaceum* cottons, Surtee-Broach and Goghari are more affected than Wagad. In the former a large proportion as 17 or even 19 per cent. has been noticed. In 1915, at Dharwar, careful examinations were made and it was found that 19 per cent. of Goghari plants were affected, and 15 per cent. of Broach, while only two per cent. of Kumpta showed the characteristic malformation. This was a very bad year, however, and in the last season (1919-20) not more than 0.1 per cent. of the Kumpta plants were affected by the disease.

The malformation is also affected by season, though exactly in what way is not quite clear. In general, it may be said that a light rainfall, with long breaks between the rain, seems to favour its

development. The following table for several seasons at the Surat Farm shows the effect of season, and also the extent of difference between different plots in the same year.

Year	PERCENTAGE OF AFFECTED PLANTS		Seasonal remarks
	Highest	Lowest	
1914-15 ..	1.5	1.0	Heavy rainfall with slight breaks.
1915-16 ..	8.5	4.1	A drought year, short period of rainfall followed by long breaks, with late rains.
1916-17 ..	7.0	1.0	A heavy rainfall year. The season started with light falls with one long break of 3 weeks.
1917-18 ..	1.6	nil	A very heavy rainfall year.
1918-19 ..	4.2	2.0	A drought year, stormy heavy fall in the beginning, followed by light falls, the rains stopping very early.

Among other observations at Surat, as to the conditions affecting the disease, it may be remarked that where cotton seed is dibbled before the rain comes, the resulting plants seem more affected than those sown immediately after the rains break, and that late-sown cottons seem to be least affected.

There is no evidence that the malformation is hereditary. The seeds obtained from the healthy branches in malformed plants, or even the few seeds from the malformed branches themselves were sown, but the affection did not appear at all either in the first or second generation of self-fertilized flowers at Dharwar. At Surat, where larger tests were made, there was an imperceptible difference in the attack of the disease when seed from healthy or malformed plants were taken. Where selection has gone on for fifteen years in cotton, the seed of affected plants being rejected each year, there is a very slight reduction in the proportion of attack at Surat.

At Surat, in plots very highly manured with night soil, the affection has been less than on the rest of the farm. It has, on the other hand, been greater in cotton grown without rotation, than when other crops like *jowar* (*Andropogon Sorghum*) are taken in the alternate years. In rotated cotton, apparently cotton coming after *til*

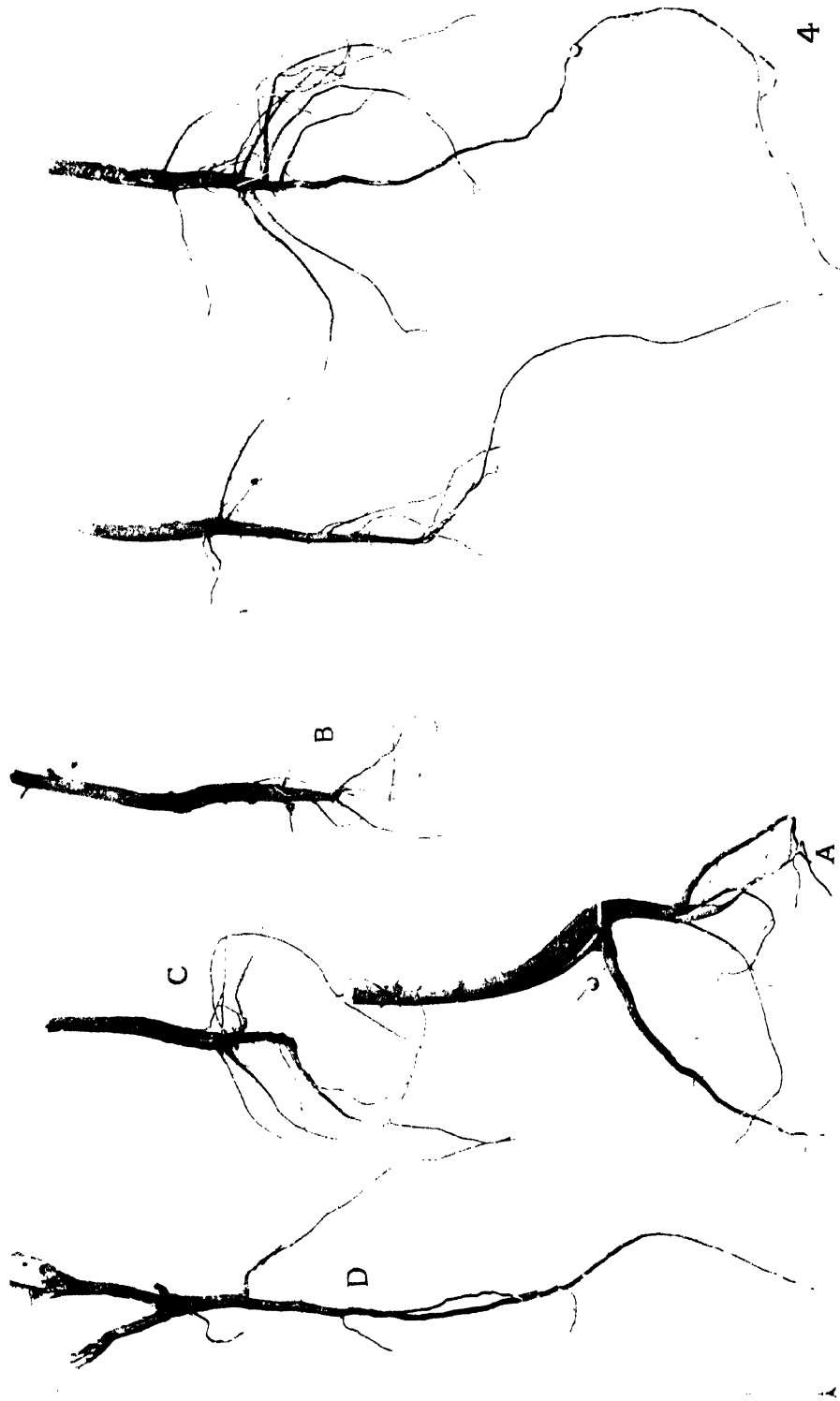

Fig. 1. Abnormal root system of the affected plants.

Fig. 2. The normal root system of the stubble and a plant with malf med bunch of short branches.

(*Sesamum indicum*), *tur* (*Cajanus indicus*) or groundnut, is more affected than when it comes after *jowar* (*Andropogon Sorghum*). Again, land ploughed thoroughly with an iron plough contained more affected plants than land which had not been ploughed, and again land of a slightly saltish character or where brackish irrigation water has been used seems to produce a larger proportion of affected plants. This is in accordance with observations elsewhere. Finally, ratoon plants, that is to say plants allowed to grow up again after cutting down the cotton stalks, give a considerably greater proportion of malformation than the original crop.

The plants show, as already stated, no sign of an animal or vegetable parasite. This has been the result of examinations made in Pusa (1916-17) and in Poona on several occasions.

The malformation seems to be connected with a change in the root development, which is illustrated in the attached figures. When the affected plants are uprooted, the main tap root in totally malformed plants seems to have abruptly ended giving a number of secondary roots (Plate XLV, fig. 1 A and B). In partially affected plants the root system seems very much weaker and less extensive than is normally the case (Plate XLV, fig. 1 C and D). When, however, the affection only results in a malformed bunch of leaves at the base, or when only the secondary growth from the stubbles is malformed, then the root system is normal (Plate XLV, fig. 2). On the whole a diseased plant seems much more easily uprooted than a healthy one.

At present it is quite impossible to suggest a cause for this disease or a method of treatment. The fact that non-rotated cotton is highly affected and that saltish land seems to induce the disease, may, perhaps, give the clue to a method of prevention. But further investigation is needed and is going on, and the present note is only published to draw the attention of workers on cotton to the disease, and to induce further observations on what is undoubtedly a very important hindrance to cotton growing at least in Gujarat and the Bombay Karnatak.

THE CHEMICAL AND BIOLOGICAL ASPECT OF
BHATA SOIL, OF CHANDKHURI EXPERI-
MENTAL FARM, CENTRAL
PROVINCES.*

BY

A. R. PADMANABHA AIYER, B.A..

Offg. Agricultural Chemist, Central Provinces ;

AND

D. V. BAL, L.Ag.,

Bacteriological Assistant, Department of Agriculture, Central Provinces.

INTRODUCTION.

IN the Central Provinces there are large areas of lateritic soil called *bhata*, most of which is lying waste at present and is considered to be too poor for general cultivation. Experiments conducted at Chandkhuri Farm show that the cultivation of various crops is economically possible on such soil, the details of which were given in a paper¹ read at the Indian Science Congress at Lahore in 1918, by Messrs. Clouston and Aiyer.

It was brought to the notice of the Agricultural Chemist that sann-hemp was not making satisfactory growth in this class of soil at Chandkhuri Farm, which is situated in Chattisgarh, Central Provinces, about 16 miles from Raipur. Samples of soil were, therefore, taken to Nagpur where pot culture experiments and other investigations were undertaken.

* Paper read at the Seventh Indian Science Congress, Nagpur, 1920.

¹ *The Agricultural Journal of India*, Special Indian Science Congress Numbers 1918.



Black cotton soil.

Bhata soil.

Fig. 1.



Black cotton soil.

Bhata soil.

Fig. 2.

DHAINCHA (*SESBANIA ACULEATA*).



Black cotton soil.

Bhata soil.

Fig. 1.

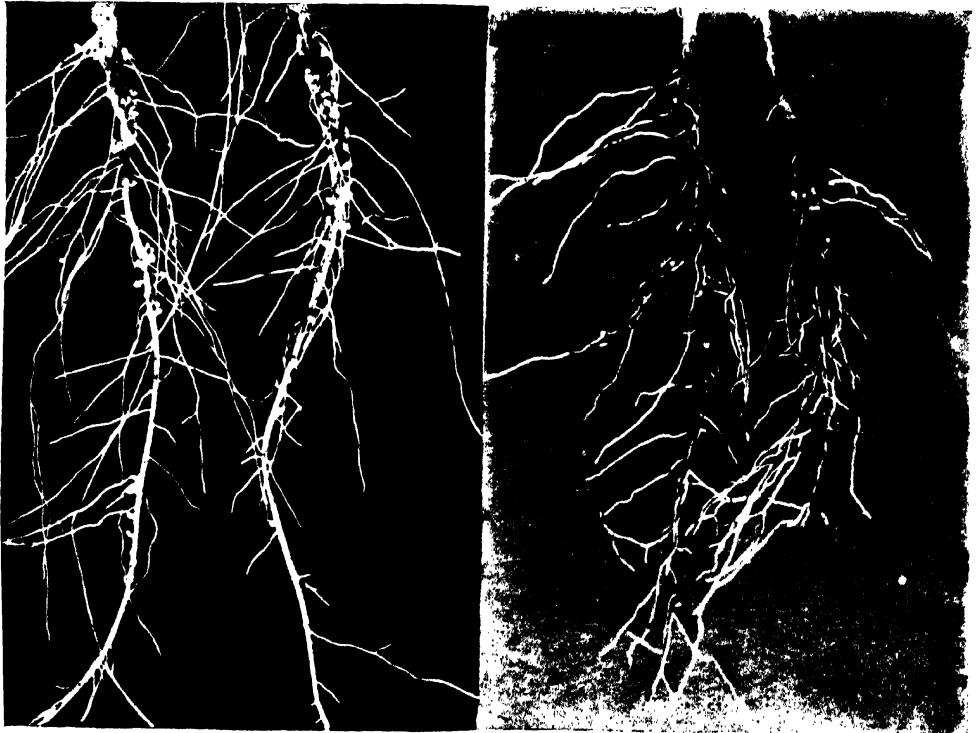

Black cotton soil.

Bhata soil.

Fig 2.
SANN-HEMP.

EXPERIMENTAL.

Physical and chemical analyses of the soil were first carried out and the figures obtained are tabulated below. It may be mentioned here that there is no uniformity in the methods adopted for the interpretation of the results of analyses. The following are some of the methods commonly used:--

- (1) The analytical figures are expressed as percentages on air dry fine soil below 1 mm.
- (2) The results are sometimes expressed as percentages on the original air dry soil.
- (3) Proportions of the various ingredients are expressed as lb. per acre up to a depth of either 8.9 or 12 inches depending upon the nature and depth of soil.

Of the methods mentioned above, No. 1 is commonly used in most of the agricultural laboratories. Figures expressed according to this method would be comparable only when the different soils under comparison contain a small proportion of stones and gravel. But as the *bhata* soil contains an unusually high proportion of stones and gravel, such a representation might be quite misleading. The analytical figures are, therefore, represented as percentages on the original soil and as lb. per acre. The figures of black cotton soil are also given for comparison.

TABLE I.

Showing the physical and chemical analyses of bhata and black cotton soils.

	% on original soil	
	<i>Bhata</i> soil	Black cotton soil
Stones and gravel	69.00	10.00
Coarse sand	9.53	9.17
Fine sand	5.21	6.68
Silt	6.02	11.29
Fine silt	3.84	17.67
Clay	3.71	38.27
Moisture	0.70	3.00
Loss on ignition	1.77	2.72
Calcium carbonate	0.08	1.44
TOTAL	99.86	100.24

	% on original soil	
	Bhata soil	Black cotton soil
Nitrogen	0·024	0·030
Total phosphoric acid	0·019	0·180
Available do.	traces	0·008
Total potash	0·264	0·770
Available potash	0·050	0·041
Calcium carbonate	0·080	1·440
Organic carbon	0·163	0·220

TABLE II.

Showing the chemical composition in terms of lb. per acre up to a depth of 8 inches.

	Bhata soil	Black cotton soil Nagpur
Nitrogen	648·2	1097·7
Total phosphoric acid	513·2	6586·3
Available do.	traces	292·7
Total potash	7129·9	28284·6
Available potash	1350·4	1500·2
Calcium carbonate	2160·6	52690·2
Weight of a cubic foot of soil up to a depth of 8 inches	62	84
Weight of soil per acre to a depth of 8 inches	27,00,720	36,59,040

From the foregoing figures of analyses it will be seen that this soil contains a very low proportion of fine material, in fact, only about 7·5 per cent. Within the range of action of a plant's roots there is a deficiency in phosphoric acid and lime.

EXPERIMENTS ON LEGUMINOUS CROPS.

Since sann-hemp was not making satisfactory growth on this soil various other legumes were also tried in pots containing *bhata* soil. For comparison, pots of black cotton soil from Nagpur Farm with the same legumes were grown alongside, as this class of plants is known to make good growth in black cotton soil. °

It was found in every case that the plants in black cotton soil made a much better growth than those in *bhata*, inspite of the fact that the latter is a more open soil. For the relative growth of *dhaincha* (*Sesbania aculeata*) and sann-hemp see Plate XLVI, fig. 1, and Plate XLVII, fig. 1.

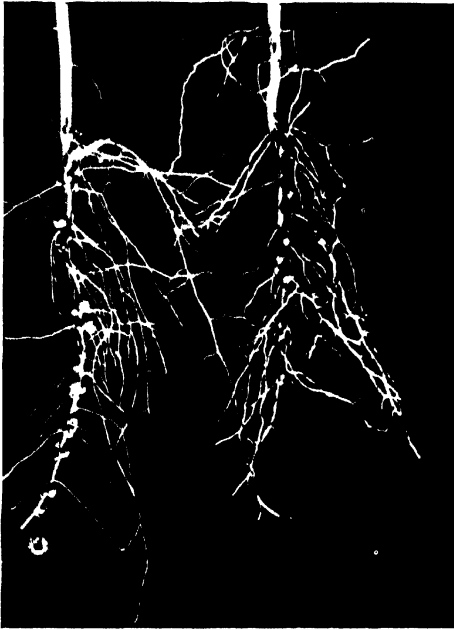

Black soil. Bhata soil.
Fig. 1. *Cajanus indicus*.

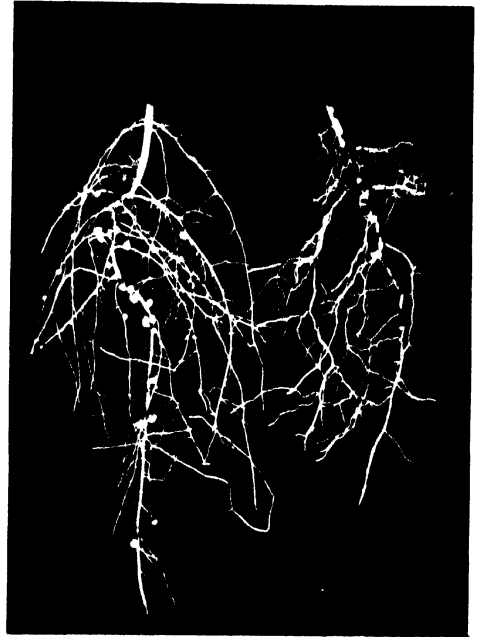

Black soil. Bhata soil.
Fig. 2. Cowpea

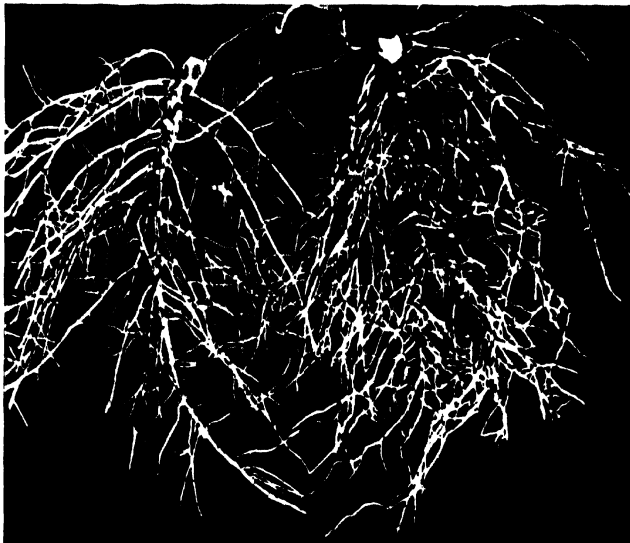

Black soil. Bhata soil.
Fig. 3. Groundnut.



Control Inoculated Cake Cake and Inoculation.

Fig. 1.



Control Lime Super Super and Lime.

Fig. 2.



Control Super Super and Lime Basic Slag.

Fig. 3.

SANN-HEMP IN BHATA SOIL.

In order to find out whether there was any relationship between the plant growth and root development, the latter was first studied. From Plate XLVI, fig. 2; Plate XLVII, fig. 2; and Pl. XLVIII, it will be seen that with the exception of groundnut all other leguminous plants grown in black cotton soil showed a much larger root and nodule development than those grown in *bhata* soil. It may be remarked that this farm had been growing groundnut for two to three years before the sample of soil was taken and probably by that time the crop must have become adapted to the soil.

In view of these observations, in the following season *bhata* soil was inoculated with an emulsion of black cotton soil and sann-hemp was again grown. This gave a very decided increase in the growth of the sann-hemp crop (Plate XLIX, fig. 1).

In order to determine further whether poverty in growth was due to lack of plant food, manurial experiments were also tried. The manures lime, super, super and lime, basic slag and *til* (sesamum) cake were employed to supply lime, phosphoric acid, organic matter and nitrogen.

A striking result noticed was that super gave an immediate return in the form of increased weight. Lime, when used alone, had a depressing effect and had no advantage when used in conjunction with super (Plate XLIX, fig. 2). Basic slag gave a slight increase in crop growth (Plate XLIX, fig. 3). The effect of cake was distinctly marked, showing need of the soil for manures of this type (Plate XLIX, fig. 1).

A very striking result was, however, produced when cake was applied to the *bhata* soil and the latter was inoculated with an emulsion of the black cotton soil. It was observed that the plants from these pots were the best of the whole series both from the point of general growth and root and nodule development (Plate XLIX, fig. 1). This fact would indicate that the *bhata* soil is not only deficient in nodule forming organisms, but is also probably deficient in organisms associated with the decomposition of organic matter. This deficiency may be either in kind or number. The average relative heights and weights of sann-hemp plants from the various pots are shown in Plate L.

In order to obtain some idea of the biological activities of the soil the usual biological examination was carried out. Instead of giving the details of all the biological experiments, only those that are of more importance and of interesting nature are given below.

AMMONIFICATION IN REMY'S SOLUTION.

100 c.c. Remy's solution was inoculated with 1 gm. of soil. For comparison the ordinary black cotton soil was also started side by side.

TABLE III.

Showing in milligrams nitrogen ammonified.

	After 24 hours	After 48 hours	After 3 days	After 7 days
<i>Bhata</i> soil	15.4	45.5	77.98	98.35
Black cotton soil	2.8	9.2	31.70	82.00

The results show that this soil has quite satisfactory ammonifying power and this fact is further corroborated by the following experiments.

AMMONIFICATION AND NITRIFICATION.

Oil-free *til* cake supplying 60 mgm. nitrogen per 100 gm. of the soil was employed and water equal to $\frac{1}{2}$ saturation was added.

TABLE IV.

Showing % nitrogen ammonified and nitrified.

	AFTER 2 WEEKS		AFTER 4 WEEKS		AFTER 6 WEEKS		AFTER 8 WEEKS	
	% N as NH ₃	Total % N nitrified	% N as NH ₃	Total % N nitrified	% N as NH ₃	Total % N nitrified	% N as NH ₃	Total % N nitrified
<i>Bhata</i> soil sampled through 1 mm. sieve	85.86	0.085	48.5	23.90	27.0	42.7	25.2	59.7
<i>Bhata</i> soil original including stones and gravel ..	87.70	0.000	74.6	7.85	42.0	19.2	46.6	32.0
Black cotton soil ..	24.10	9.000	9.6	45.00	2.3	65.5	..	70.0 to 85.9

The total % N nitrified referred to in the above table includes both nitrite and nitrate nitrogen.

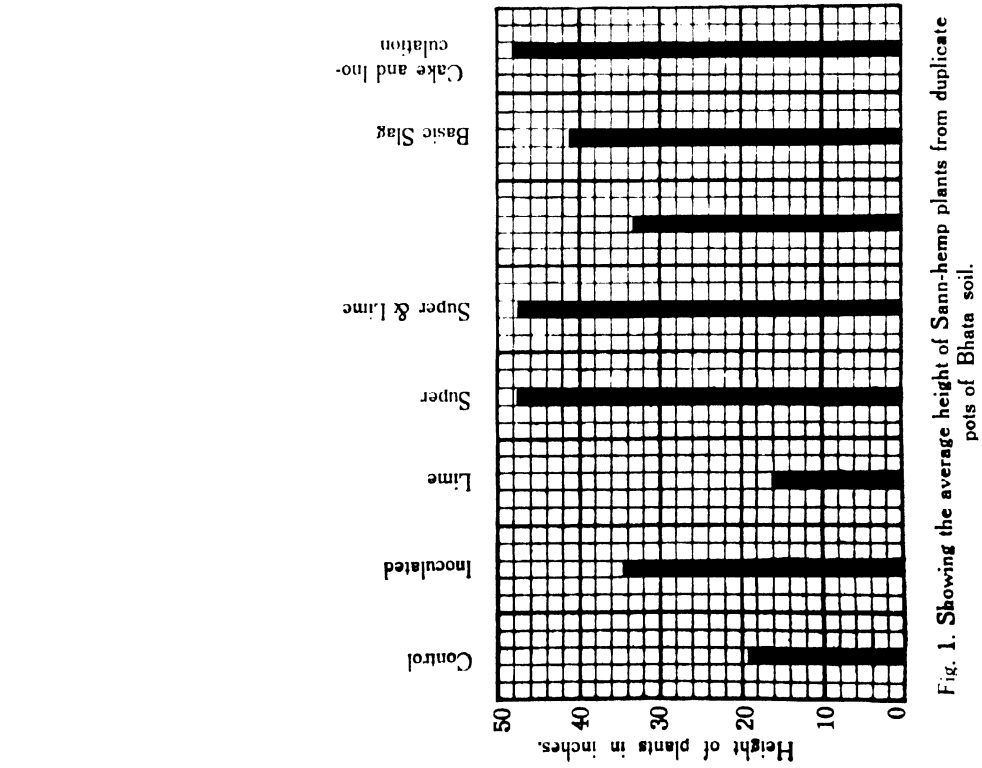

Fig. 1. Showing the average height of Sann-hemp plants from duplicate pots of Bhata soil.

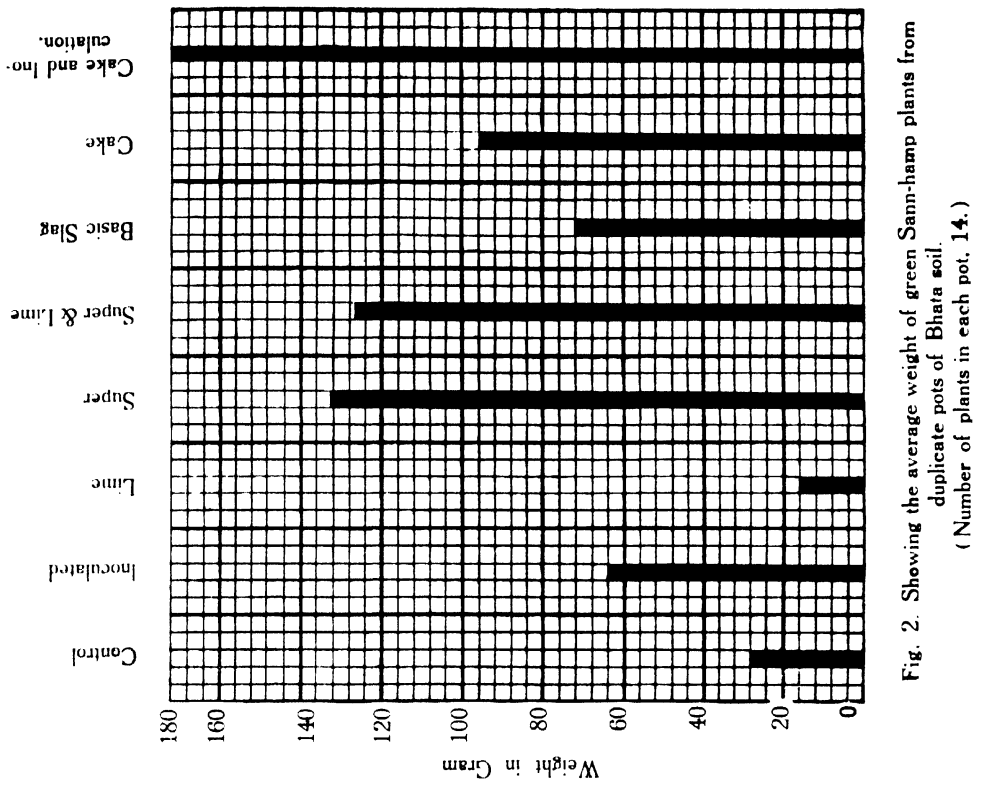

Fig. 2. Showing the average weight of green Sann-hemp plants from duplicate pots of Bhata soil. (Number of plants in each pot, 14.)

These results show that the ammonifying power is quite good and that the nitrification, though not as good as in black cotton soil, can be called average. The difference in nitrification in the sampled and the original soil is quite striking and may be explained by the increased soil surface present in the finer grained sampled soil.

NITROGEN FIXATION.

Nitrogen fixation, as found out from Ashby's mannite solution, appears to be weak. *Bhata* soil fixes about 4.5 mgm. of nitrogen per gram of mannite as against 9 to 10 mgm. fixed by black cotton soil.

The bacterial content of the soil increases rapidly when organic manures are added. In a sample of *bhata* soil taken from an unmanured area from Chandkhuri Farm, the average number of bacteria found was about 0.9 million per gram of soil, whereas in case of soil taken from a plot manured with cake and cattle dung the number was practically double, *i.e.*, 1.7 millions per gram of soil.

We have to acknowledge the assistance and advice given from time to time by Mr. F. J. Plymen, now Deputy Director of Agriculture, Western Circle, Central Provinces, in starting and developing these experiments.

SUMMARY.

(1) Chemical, physical and biological analyses of the *bhata* soil were carried out. It is deficient in fine particles and contains about 69 per cent. of stones.

(2) Experiments conducted show that *bhata* soil responds to manuring with phosphoric acid and organic matter.

(3) It contains the necessary micro flora required for ammonification and nitrification and has also got the advantage of aeration and drainage due to its porous physical constitution.

(4) The poor growth of leguminous crops in the newly cultivated *bhata* soil appears to be due to want of phosphoric acid and a scanty formation of nodules.

(5) This latter defect is naturally removed to a great extent by continuous cropping. When the soil is to be newly cropped with legumes it can be successfully assisted by the application of cake and inoculation.

Selected Articles

THE GROWTH OF THE SUGARCANE.*

BY

C. A. BARBER, C.I.E., Sc.D., F.L.S.

V.

It is well known that different varieties of sugarcane ripen at different times even when planted together, and this has recently become an important factor in milling, as by a careful combination of varieties the season during which matured canes can be obtained is lengthened. Some interesting work has been done on this subject by Somers Taylor¹ with the canes growing in the Bihar sugar tracts of North India. He had as material local canes belonging to the earliest and latest in India, namely, varieties of the *Saretha* and *Mungo* groups. He found that when planted at the same time, good sweet juice was obtained from *Khari* as early as in December, whereas in several members of the *Mungo* group the canes were quite unripe at that date. These latter varieties could only be harvested profitably in March, while the best time to cut *Khari* was during January and February. The same kind of thing is known in many thick canes, but our knowledge is far from complete and it is highly desirable that more accurate information should be recorded than the casual observations at present available.

But even with a certain amount of knowledge as to the period at which a cane may be expected to mature it has often been found difficult to tell exactly when it is best to cut it. This is, because, the

* Reprinted from the *International Sugar Journal*, April 1920.

¹ Woodhouse, Basu and Taylor. "The distinguishing characters of sugarcane cultivated at Sabour. *Memoirs of the Department of Agriculture in India, Botanical Series*, Vol. VII, No. 2, April 1915.

multitude of canes brought into the mill vary a great deal among themselves, some being just ripe, and others over or under matured as far as the richness of the juice is concerned. This variation in canes of the same kind we may readily imagine to be due to the fact that the canes of a bunch are not of equal age, as we have seen in our last paper.¹ The canes developed in succession, the *a*'s, *b*'s, *c*'s, etc. ripen one after another, and it becomes of some importance to know the true formula of a particular kind, in order to see which of these orders of branches is present in the greatest number. If the *b*'s are the most numerous, then it will be advisable to cut the canes after the *a*'s have somewhat passed their maturity, and if the *c*'s are present in larger numbers, then it would be advisable to concentrate on their ripening period, and so on. But it is unsafe to judge entirely by numbers, for, as we shall see, the canes of different orders of branching differ very markedly in their weight, their total length and the length and thickness of their joints, and also in the rapidity with which they mature. These differences in appearance will, however, be of use if we wish, at the mill, to pick out the branches of different ages and submit them to a more detailed chemical study.

In the first place let us consider the rate of maturing of the cane plant as a whole. It can be seen by anyone passing along the rows of canes growing in a trial plot that some, at three or four months of age, are habitually more forward than others in forming cane. It is usual to judge of this by the first formation of naked joints near the ground which have the normal thickness of the variety; but this is rendered difficult in some kinds by the close envelopment of leaves, which sometimes remain attached during the whole life of the plant. This is the case with most Indian varieties and, to make accurate comparisons, it is desirable to take out and clean the plants and make dissections to show their branching systems. During 1916 to 1918 some 350 plants were thus dissected at the Cane-breeding Station at Coimbatore, when from three to four months old. As the formation of canes is extremely rapid at this

¹ *Agricultural Journal of India*, September 1920.

period and the dissection took a very appreciable time, the subsequent comparison became extremely difficult. It is not proposed here to mention in detail these and other difficulties which were met with, nor the means adopted to overcome them, but merely to give in general terms the result of the study. This will be seen from the following statement, in which the various groups are placed in order of development:—

Early maturing: *Saretha* (brown), *Nargori*, *Pansahi*, *Saretha* (as a whole), *Sunnabile* (Dhaultu section), *Mungo* (only *Kharvi*);

Moderately early: *Saretha* (green section), *Saccharum spontaneum*, thick tropical canes;

Late maturing: *Sunnabile* (as a whole), *Mungo* (as a whole), *Mungo* (without Dhaultu section), *Sunnabile* (Dhor section).

It is extremely desirable that similar lists, founded on careful observations, should be compiled of the rate of cane formation in comparative varietal plots. The kinds that really matter in such plots are generally few in number, and the work could be done each year in a much shorter time than that done at Coimbatore, thus ruling out the difficulties which were met with there.

The study of the differences between the branches of different orders, namely, the *a*'s, *b*'s, *c*'s, etc., was also a difficult piece of work. It had long been felt that such a study was needed, because of the occasional observation, especially in certain varieties, of those thick, late-formed shoots, called "gourmandizers," which usually had little sugar in them at crop time. But a final decision was arrived at, when it was found out that the canes in each bunch were not uniform and in fact differed so much among themselves that the current method of sampling a plot of canes was likely to introduce serious errors. Thus, when picking out 20 canes at random for measuring, it was easy, in certain varieties, to separate them into different classes which on examination turned out to be of early and late formation. The former were longer and thinner, had more and shorter joints, and had apparently richer juice. In our study of seedling canes these differences among the canes of different ages in the same plant were found to be much more pronounced. The colour often varied with the age from green or yellow to grey or

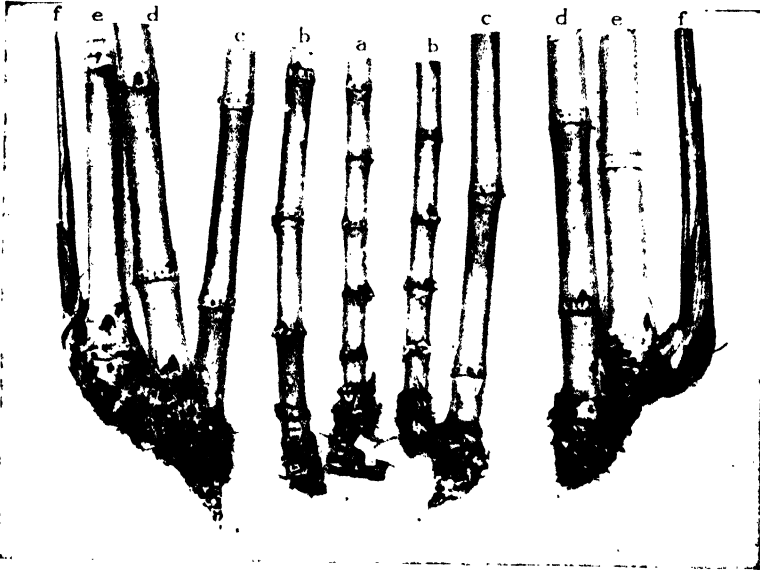

Branches of different orders in the dissection of *Saccharum arundinaceum*.
 The main stem, *a*, is in the centre, and *bs*, *cs*, *ds*, *es*, and *fs* are
 arranged on each side, passing outwards from the middle.
 The characters of these branches are as in Plate LII.

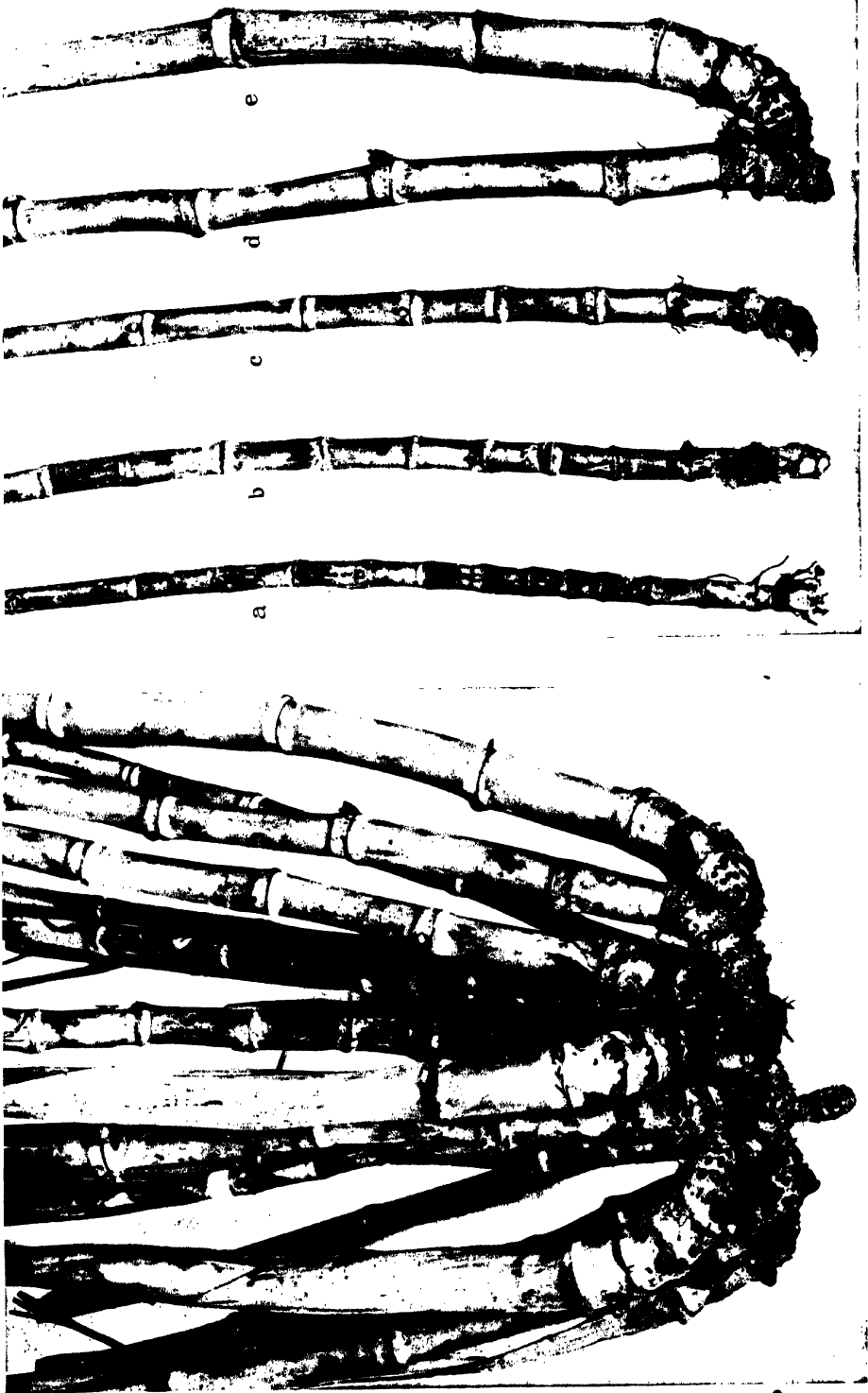

A dissected plant of *Pansahi*, nine months old, with typical branches of different orders spread out. There is a progressive increase in the length and thickness of the joints and the curvature of the canes, while rooting on the joints becomes less evident. The main stem has a piece of white paper round i

even purple, the thickness was sometimes three times as great in the later canes and the proportion of rooting and general habit differed quite as much. It soon became necessary to lay down rules as to which canes in the bunch should be selected as typical of the seedling, both as to its external form and the richness of its juice. When, therefore, the dissection work was taken up on a large scale, a series of measurements of each and every cane was introduced, from which to learn something of the meaning as well as the persistence of these differences. The results have fully justified the enormous amount of labour involved.

In the plants of *Saccharum arundinaceum* and *Pansahi* shown on Plates LI and LII some of these differences are very clearly shown ; it is at once obvious that the *a*'s, *b*'s, *c*'s, etc., vary greatly in certain characters. Among the characters chosen for special study were the rate of cane formation, the thickness and length of the canes, the shape of the cane, and the amount of curvature of the base, the amount of rooting and shooting, the richness of the juice and so on. Averages have been struck in all the canes of the same order of branching, in each plant, clump, variety and group, as well as the whole series dissected, and some of the results are given briefly below.

(1) *Rate of early development.* Included in this term is the period between the shooting of the bud and the completion of the thickening of the cane, after which it proceeds to add joint to joint as the leafy shoot is thrust into the air. The region concerned consists of short, disc-like, superposed joints which gradually become thicker and longer, and, after some study, it was decided to limit it upwards by the first joint which had reached one inch in length. After this the thickness did not appear to vary much and the joints quickly assumed their usual length. The length of this basal, preparatory portion of the cane was carefully measured in each and every cane of the hundreds of plants dissected, and the results were tabulated and averaged. It was found that the *a*'s, that is the main shoots, were much the slowest in development. This is indeed not to be wondered at, when we consider the quantity of roots and leaves at the disposal of the plant at this period. The main branches

(*b*'s), on the other hand, starting from a ready formed cane with larger equipment of root and leaf, went through their preparatory period much more rapidly, and this rate of development was seen to increase in subsequent orders of branching. But the matter soon became complicated by the fact that the later branches had to place themselves further from the centre of the plant for free growth, thus introducing a curvature at the base which is not seen in the *a*'s or generally the *b*'s. This curving region increases with the order of branching and mere measurements of the length of the basal portion were insufficient to demonstrate the rate of development. This fact must be taken into consideration in the figures that follow. The average length of the basal portion in all the *a*'s and *b*'s measured was 3·7 and 2·6 inches respectively. Taking only the *Saretha* and *Pansahi* groups of Indian canes and the six thick tropical canes we have the following averages (in inches):—

				<i>a</i>	<i>b</i>	<i>c</i>	<i>d</i>	<i>e</i>
<i>Saretha</i> group	3·4	1·7	2·0	2·4	(2·0)
<i>Pansahi</i> group	3·1	2·0	2·1	2·5	2·3
Thick canes	2·8	2·4	2·8	(3·8)	..

The figures in brackets being founded on an insufficient number of measurements for accurate determination.

(2) *Average length and thickness of the mature joints.* The measurements in joint length were commenced after the basal part had been passed, that is, after joints one inch in length had been reached; the thickness was taken of the cane at two feet from the base. The differences in these respects of the branches of different orders are very well seen in the Plates, and it is merely necessary here to record the averages of the actual measurements taken. As has already been stated, the observation of such phenomena has always been found much easier in the *Pansahi* group of canes and in the wild *Saccharum arundinaceum*, and these have been selected for reproduction, because they show the differences so well. Averages are also added for the *Saretha* group and for the six thick cane varieties dissected. There is much more variation in these, and no individuals if figured would be likely to present the matter in so striking a manner; but by the averaging of a very large number of

measurements in each (usually many thousands) these irregularities have been ruled out and they fall well enough into line :—

*Average length of matured joints above the basal part,
in inches.*

					<i>a</i>	<i>b</i>	<i>c</i>	<i>d</i>
<i>Saretha</i> group	2.2	2.8	3.3	4.5
<i>Pansahi</i> group	2.1	2.8	3.3	3.6
Thick canes	1.8	2.4	2.8	3.0

Average thickness of cane at two feet from the base in cm.

					<i>a</i>	<i>b</i>	<i>c</i>	<i>d</i>	<i>e</i>
<i>Saretha</i> group	1.59	1.66	1.78	1.92	2.04
<i>Pansahi</i> group	1.66	1.66	1.88	2.23	2.84
Thick canes	2.63	2.82	2.90	3.45	..

(3) *Richness of juice in branches of different ages.* This has been the subject of repeated study in the *Pansahi* group of canes, where the cut canes can be so readily divided into early (*a*'s and *b*'s) and late (*c*'s and *d*'s), and the results are very interesting. Two sets of analyses are given, which were made in 1916-17 and in 1917-18.

Sucrose in the juice of members of the Pansahi group.

		Per cent.		Per cent.	
1916-17	..	<i>Maneria</i> (one clump) : early canes	..	11.30	late canes 9.52
		Ditto (whole row)	..	10.29	7.24
		Yuba (6 canes each from one clump)	..	10.61	7.94
		Per cent.		Per cent.	
1917-18	..	<i>Maneria</i> : very early canes	..	16.90	early 16.40 to 16.48 late 13.90
		Yuba	..	17.81	,, 17.17 to 17.77 ,, 16.13

From these examples we see that, in the samples taken, the earlier or older the canes the richer the juice, and it would be interesting to compare these results with analyses taken at other places, especially as the sucrose content of the members of the *Pansahi* group appear to have so much richer juice in other tropical countries than in India. Thus far we have failed to establish similar relations of the juice richness in other groups of canes, possibly, because of the fewness of the observations and the irregularities in such groups.

From these and other facts elicited regarding the character of the juice in canes of different ages and in the different joints of

cane during its growth, we have been led to a certain conception as to what goes on in the ripening cane, as of influence on the behaviour at the mill, and it may be of interest to place it on record. The cane plant commences in a small way and, at first, is only capable of small things. But, as it gets bigger, has more roots which penetrate deeper into the soil and has larger and more numerous leaves wherewith to obtain food from the atmosphere, its capacity increases and greater numbers of thicker canes are produced. Each cane, as it reaches its appropriate thickness, proceeds to grow in length, but its joints, being at first young and tender, are filled with sap devoted to the building up of fresh tissue. But as the tuft of leaves is pushed into the air by the formation of new joints, one for each leaf, the older joints become less intimately connected with tissue formation. They become more mature and their large central cells become inert and charged with cane sugar, while the more actively living tissues are limited to a narrow external band, whose main function is the transmission of food from the roots to the shoot. When all but the uppermost joints reach this later stage, the cane is said to be mature and is ready for cutting. It does not seem likely that anyone will quarrel with this conception of the sequence of events.

We have seen that the canes of a bunch arise in succession, first the mother shoots from the buds on the set, then the branches of the first order and, later, those of the second, third and other orders, according to the system of branching as determined by the formula. A study of the dissections shows that there is usually a considerable period between the appearance of the first and last canes of each plant. In all of these the same sequence of changes may be assumed to take place in the contents of the joints, and thus there will be considerable differences in the times at which the different canes arrive at maturity and are fit for the mill. We have some reason then to suppose that the canes at crop time will not be equally matured, unless indeed no further change takes place in the canes after they have reached maturity. But there are abundant signs that such a change does take place, although it appears to differ in extent and rapidity under special local conditions and in different kinds of cane. There are in fact evidences that, after a

cane has matured, if left uncut, a process of deterioration sets in, the main result of which is that the purity of the juice and the quantity of sucrose in it decreases. The causes which induce this change in the stored sucrose in the large cells of the joints need not concern us here. The following analyses will illustrate our point. They were made at the same time as those of *Maneria* and *Yuba* quoted above in 1917-18. It was, at the time, recorded that the tops of these canes had withered because of drought, but the analyses were made just the same to see what the effect of this premature maturing would have on the juice.

Sucrose in the juice.

		Per cent.	Per cent.	Per cent.
1917-18 ..	<i>Pansahi</i> : Very early canes ..	13.78 ..	early 15.88 to 16.28	late 13.66
	<i>Suda Khujce</i> : ..	13.82 ..	16.58 to 17.84	

From these facts we learn that in each cane there will be a gradual rise in the quantity of sugar in it until an optimum is reached, after which there will probably be a more rapid decline in its content of this substance. If we take a milling period of one hundred days and assume that but one kind of cane is grown, all of it planted at the same time, we should in practice be most of the time cutting many canes which are not by any means at their optimum as regards sugar content. We should commence with the cutting when the mother canes are ripe, but their branches would be increasingly unripe, the higher the order of branching and the later they had risen in the bunch. Then, when the mother canes were a little past their prime, the *b*'s would be at their optimum, but the *c*'s and *d*'s would still be unripe; lastly, when the latter canes became fit for the mill the mother canes would be much deteriorated and the *b*'s would also have passed their optimum of sugar content.

• The best time to reap a crop will be when the greatest weight of canes is mature; this will depend on the formula, and will, for instance, be very different for *Yuba* and *B.208*, and probably for *Red Mauritius* as compared with either. The formulæ tend to be symmetrical on each side of a certain order of branching, and if the system is small there will be most *b*'s, if large most *c*'s; but it is to be remembered

that not only the number, but the individual weight of the canes, has to be considered and this is invariably greater in the *c*'s than the *b*'s. It will be seen that there is plenty of scope for study in this matter, and it would be well, in the selection of early and late maturing canes, which will be necessary to extend the milling season to as great a length as possible, also to consider the optimum ripening of the canes of different orders of branching. With the marked differences to be observed between the early and late canes as detailed above, it should be possible with a little care to separate them at the mill, and it is suggested that an occasional analysis of the canes of different ages and stages in ripeness may be of use in getting the greatest amount of sugar out of the crop.



NATIVE CANE IN FLOWER, TUCUMAN, ARGENTINA.

THE 1919 TUCUMÁN SUGAR CROP.*

BY

W. E. CROSS.

FOR the harvest of 1919 in Tucumán there were some 183,000 acres of cane, of which some 160,500 acres were of the Java seedling varieties, principally POJ 36 and POJ 213, and 22,500 acres of the native cane (purple and striped) (Plates LIII and LIV). Of the entire extension of cane planted, 64·8 per cent. belonged to the factories and 35·2 per cent. to the independent cane growers. The total amount of cane produced was approximately 3,685,000 short tons, of which some 220,000 short tons were of the native cane, the rest being Java. The tonnage yield of the Java cane was thus around 21·5 short tons per acre, and that of the native cane around ten tons. The total amount of cane produced was not quite all ground as some 100,000 tons were left till next year and a small quantity was used for planting. The exact tonnage of cane which was worked up in the twenty-seven factories which operated was 3,555,329 short tons, the total amount of sugar produced being 271,286 short tons, not counting a small amount of hot room goods which will be purged in 1920. The average yield of sugar per hundred cane in the factories was thus 7·6 per cent.

* Reprinted from *The Louisiana Planter and Sugar Manufacturer*, dated 5th June, 1920.

The amount of cane ground and the yields obtained in the various factories will be found in Table I.

TABLE I.

Factory	Cane ground (short tons)	Sugar produced (short tons)	Sugar produced % cane
Santa Ana	315,882	21,558	6.82
La Corona	189,781	13,702	7.22
La Trinidad	160,018	12,702	* 7.93
Mercodeo	166,858	12,241	7.33
La Florida	248,947	22,491	* 9.03
San Pablo	245,141	21,100	8.60
Concepcion of Lujan	395,650	31,619	7.99
Lastenia	141,050	11,875	8.41
Bella Vista	310,871	21,987	6.89
Nueva Baviera	108,135	10,361	* 9.58
El Paraiso	64,391	4,436	6.89
Esperanza	122,313	8,905	7.28
La Providencia	75,904	4,944	6.51
Los Ralos	133,423	10,543	7.90
San Juan	79,177	6,757	8.53
San Andres	100,149	7,699	* 7.68
Santa Rosa	54,789	3,391	6.19
San Josa	62,761	4,465	7.11
Santa Barbara	34,676	2,417	6.97
Santa Lucia	96,689	6,615	6.48
Cruz Alta	105,224	7,413	7.04
La Invernada	24,783	1,186	4.78
Amalia	90,566	6,961	7.68
Aguilares	85,487	6,265	7.33
San Antonio	113,269	7,840	6.92
El Manantial	29,395	1,813	6.17
Total	3,555,329	271,286	7.63

* Raw sugar.

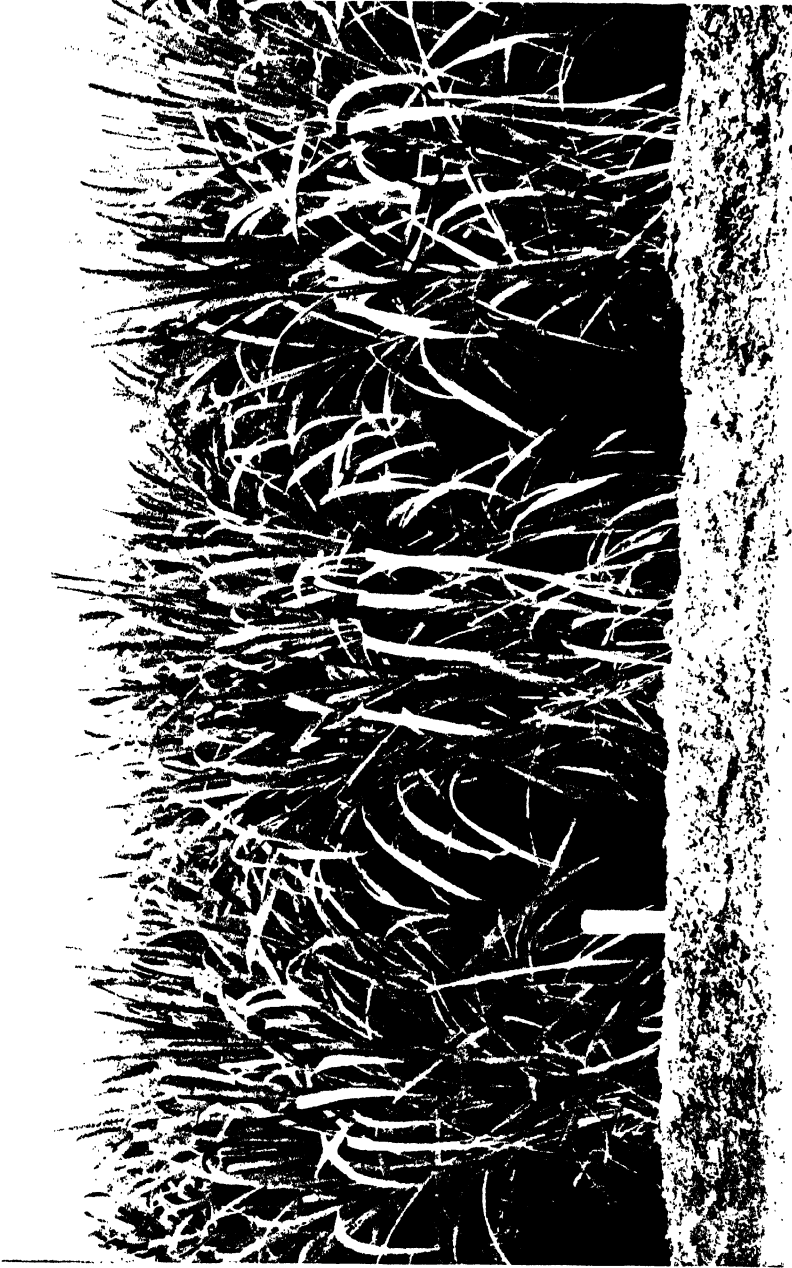

TYPICAL POJ 213 CANE IN TUCUMAN.

All the factories produced principally white sugar for direct consumption, except the four indicated by an asterisk in the Table.

Before going on to discuss the year's crop in its various aspects, it will perhaps be worth while to give the results obtained in previous years. Table II shows the cane production, and Table III the sugar production in the last ten years.

TABLE II.
Cane crop, 1909-1919.

Year	Total acreage (acres)	Total cane produced (short tons) *	Cane per acre (short tons)
1919	183,000	3,685,000	20.1
1918	180,000	1,819,044	10.1
1917	228,872	756,220	3.3
1916	160,283	973,810	6.1
1915	277,235	1,981,459	7.1
1914	263,709	3,276,575	12.4
1913	257,621	2,873,681	11.2
1912	224,483	1,964,330	8.8
1911	218,540	2,214,305	10.1
1910	209,273	1,675,488	8.0
1909	173,105	1,850,918	10.7

Excluding the amount of cane used for planting.

TABLE III.

Year	No. of factories working	Sugar produced (short tons)	Sugar per acre (short tons)	Sugar extracted on 100 canes
1919	27	271,286	1.48	7.63
1918	26	95,765	0.53	5.26
1917	19	48,963	0.21	6.47
1916	21	49,143	0.31	5.05
1915	26	114,664	0.41	5.79
1914	28	307,387	1.17	9.38
1913	28	250,972	0.97	8.73
1912	27	134,306	0.60	6.84
1911	27	163,088	0.75	7.37
1910	27	128,791	0.62	7.69
1909	28	115,106	0.66	6.22

The very remarkable variations in the annual yields of cane and sugar per acre during the last ten years will be seen in these Tables, which give some idea of the really appalling crisis through which Tucumán has just passed. This crisis, as is perhaps known to

the reader, was due to the sudden and final degeneration of the Cheribon cane, which took place in the years 1915-17. The crisis forced the planters to accept the recommendation of the Experiment Station, to renew their entire plantations with the Java seedling varieties POJ 36 and POJ 213; and this they did so rapidly that in 1918 over 80 per cent. of the total cane harvested was of these varieties. This entire going over from the old standard cane to a new variety with which very few outside of the Experiment Station had any experience, indicates at once the courage and progressiveness of the Tucumán planter, and also incidentally his faith in the Experiment Station. The year 1918 was the first year when the industry was really based on the Java varieties and the grinding season of that year was looked forward to with great interest from the point of view as to whether the Java cane would or would not justify itself as a practical proposition, and what results it would give planted on a large commercial scale all over the province. Unfortunately, just after the first month of the crop, on the 8th of July, the province was visited by a frost of an entirely unprecedented degree, with minimum temperatures in parts of the cane belt as low as 14 degrees F., which created entirely abnormal conditions and made it necessary to defer final judgment on the value of the Java varieties until the following year. Nevertheless the frost itself served to bring out one property of these canes which in itself is enough to place them in a class by themselves: their remarkable resistance to the effects of low temperatures. While the native cane became almost worthless within a week or two of the big frost the Java plant cane was more resistant, and the Java stubble could be ground right on into September, although the terminal buds and almost all the other buds were killed on the 8th of July. Seeing that at least five-sixths of the cane in Tucumán is always stubble, this experience enables the planters to contemplate future frost years with a considerable amount of equanimity.

The year 1919, then, was the greatest year of the newly-adopted Java cane. Many people were sceptical about the possibility of obtaining results on a large scale, even approximating those reported by the Experiment Station, others about the high fibre content of the

canes, the ease of clarifying their juices, etc. It is, therefore, very satisfactory to report that the harvest represented an absolute vindication of the Java varieties, for with a much smaller acreage than was common with the native canes an absolutely record tonnage was produced, in average yield of cane per acre, 20.1 tons, and especially that of the Java cane, 21.5 tons, are results entirely without precedent in the local industry. Moreover the cane proved to be entirely satisfactory in the sugar-house, and gave an excellent average yield of sugar of 152.6 pounds per ton.

The very success of the Java cane, however, brought up some quite difficult problems for the industry, in respect of the excess of production of cane, and especially of the relation of the *canero*, or cane planter, to the industry. As we have seen, about two-thirds of the cane planted is in the hands of the factories themselves, the remaining one-third belonging to these *caneros*, who sell their cane to the factories. In years of cane scarcity, such as we have experienced since 1914, the cane of these growers was at a premium, but in 1919, with an over-production, the factories found themselves in a position to buy but very little cane, so that the *canero* was unable to sell more than a small portion of his product. To meet this situation the local government passed a law compensating the growers who could not sell their cane, from funds produced by a special tax on the sugar manufactured. The law allowed the *caneros* to dispose of their cane which they could not sell to the factories, for which therefore they received compensation, in any other way they could, the compensation being for the loss of the "principal market" of the product. The result of this was that some *caneros* decided to make the experiment, not previously made in this province on a large scale, of leaving the cane over without cutting until the next grinding season. The experiment was also made by a number of the factories, the total amount of all cane thus left over being some 100,000 tons. As the 1920 season has not yet commenced at this writing, the result of the experiments is not yet known, but from the analyses of many samples of the cane made in the Experiment Station it would appear to be in excellent condition for grinding.

The very large yield of cane in the fields, and the absence of killing frosts, made it obvious in the middle of the grinding season that the mills would have to work right on till November or December, or until the advent of the summer rains should make hauling impossible, and many factory owners feared that the cane would begin to diminish in sugar content with the daily increasing temperatures of the spring and early summer months. This especially so, as the cane, early in the grinding season, began to show a tendency to flower, and while this is a very rare thing in this country, it was understood from other parts that the cane after flowering would deteriorate rapidly. Fortunately these fears were not realized; for even though a small proportion of the cane actually did flower, on the average the sucrose content and purity was maintained right up to the end of the harvest. This result was another triumph for the Java cane.

The high fibre content constitutes one of the greatest differences between the old native cane and the Java varieties, for while the former shows only 10·5 per cent. fibre, the latter canes contain usually 12·5–13·5 per cent. In one way, of course, this has been a great boon to the industry, as the amount of auxiliary fuel needed by the factories working with the Java cane has been reduced very much thereby. On the other hand, the canes are much harder to grind, and the juice extraction much less than with the criolla canes. Before becoming accustomed to the new canes a number of factories lost time through breakages, but it is anticipated that these troubles will become fewer and fewer as the factories get used to this class of cane. Nevertheless, it must be admitted that the POJ 36 has a tendency to become very hard, and that this is considered somewhat as a defect in this variety by those factories whose milling plant is not of the most modern.

One of the most remarkable features of the Java varieties, from the Tucumán point of view at least, is their exceptional rapidity of deterioration after cutting. This property was studied by the Experiment Station years ago, and it was shown to be due to inverting enzymes which the canes contained at the moment of cutting and also elaborate after being cut. The result of this is that while

the native canes can be cut at the beginning of the week and milled at the end without any appreciable loss in purity, the Java varieties must be worked up within one or two days unless very serious losses in sugar are to be suffered. As has been said, this fact was more or less known to the factories when they began to work with the Java canes, but it needed bitter experience in some cases to make the fact "sink in." But even then losses were suffered by many *ingenios* by faulty organization of the harvest and haulage as well as owing to the great difficulties experienced in trying to ensure that the cane should arrive at the mills within a few hours after cutting. As time goes on, however, and the growers and even the labourers come to realize the great necessity of sending fresh cane to the mill, these difficulties will tend to disappear. As an example of the losses entailed, we may mention the case of one *ingenio* that was grinding with 70 per cent. purity, and on milling two wagons of freshly-cut cane from the same fields found the purity to be 84 per cent.

The Java cane was found to work up easily in the factory, no difficulties of clarification or boiling, etc., being experienced as long as fresh cane was being dealt with. The cane deteriorated by being cut several days, however, gives juices which sometimes are difficult to clarify.

As has been said, the predominating Java varieties planted in Tucumán are the POJ 36 and POJ 213. The other Javan varieties planted on a relatively small scale, the POJ 228, POJ 234 and the POJ 105, have not given such good results. The POJ 228 generally gives a lower tonnage than either the POJ 36 or the POJ 213, and has also shown itself to be much more susceptible to frost damage. It, however, has the advantage of suffering less from deterioration after cutting than the other canes. The POJ 234 was planted because of its property of early maturation and this property it has maintained on the large scale. However, it does not give a sufficiently large tonnage per acre to justify its preference to the other canes, as for early cutting better results can be obtained from POJ 213, topping it one or two joints lower than normal. The POJ 105, also called here *Ambar de Egipto*, has also failed to

justify itself, owing to its comparatively low tonnage, and its susceptibility to frost damage. Finally the Kavangire, which was also planted to some extent in the province, has proved inferior to the best Java canes, owing to its very late maturing, and also to the comparatively great expense of harvesting and shipping this very thin cane, and to its hardness for milling.

The POJ 36 and the POJ 213, on the other hand, as we have seen, have been absolutely vindicated during the record 1919 crop.

Very little damage was suffered during the year from insect and fungivorous pests, probably owing at least in part to the great resistance of the Javan varieties to these pests. The cane borer, which formerly seriously reduced the sugar production of the native cane, apparently finds the rind of the Java varieties too hard, as the number of perforated stalks was comparatively small. A small amount of mealy bug was noticed, but no damage was attributed to this cause. Of cane diseases, the mosaic disease is very common here in all the canes, but it does not appear to affect the yields seriously. The root disease, which has such a serious effect on the native cane, has not made great headway with the new varieties as yet. The disease called "toprot" was in evidence to a small extent, but did not do any great damage.

Finally, mention must be made of the excellent climatic conditions of the growing season 1918-19, which undoubtedly played their part in making the year 1919 a record one for Tucumán.

FARMYARD MANURE: ITS MAKING AND USE.*

NOT many years ago it used to be the custom for certain representatives of agricultural science to extol the virtues of artificial manures, while farmers, on the other hand, stoutly maintained the superiority of farmyard manure. In recent years the position has changed. It is now the scientific worker who emphasizes the importance of farmyard manure and the need for making and storing it properly. Farmyard manure and artificial fertilizers do not compete with one another; they serve quite different purposes in the soil. No farmer can do without artificials, no matter how much farmyard manure he may have at his disposal, and, conversely, no arable farmer, except in a few special districts, would like to do without farmyard manure, even if he could have unlimited supplies of artificials at very low prices. The best results are always obtained on arable land by proper combinations of farmyard and artificial manures, although on grazing land farmyard manure may not act well.

So far as is at present known, the effects produced by farmyard manure in the soil are three:—

1. To supply nitrogen and potash to the plant.
2. To improve the physical condition of the soil, and thus increase its capacity for going into a good tilth and for holding water. The effect of this is to steady the yield.
3. To assist some of the micro-organisms of the soil; among other effects, to benefit the clover crop.

* Reprint (abridged) of a paper read by Dr. E. J. Russell, F.R.S., Director of Rothamsted Experimental Station, at a meeting of the Farmers' Club, 31st May, 1920, from the *Journal of the Ministry of Agriculture*, XXVII, No. 5.

Only in the first of these is there any competition with artificial fertilizers, and even here the competition is restricted, because artificials usually exert their full action on the crop to which they are applied, while farmyard manure does not.

THE CONSTITUENTS OF FARMYARD MANURE.

1. *The excretions.* The animal excretions constitute an important part of the fertilizing material of farmyard manure. The urine is by far the most important—it is the chief source of the immediately beneficial part of the dung. The amount and value of the urine depend on the food and on the animal; urine contains the fertilizing constituents of all the digested food which has neither been retained in the animal nor secreted in the milk.

Its composition can be calculated, and this is done in determining the manurial value of foods, but the calculation never comes out quite right, because its valuable constituents are so easily decomposable that they are readily lost.

Although the dry matter of the urine forms only about 2 per cent. of the actual weight of the dung, it constitutes a much larger proportion of the weight of fertilizing materials. A ton of dung contains about 12 to 15 lb. of nitrogen, of which about 4 to 9 lb., according to the amount of cake and corn fed, would come from the urine.

2. *The litter.* Straw is by far the commonest litter, and it forms the chief part, by weight, of farmyard manure. Broadly speaking, one ton of straw makes four tons of farmyard manure but the additional three tons is very largely water, only a small part being other excretory substances. Of 100 parts of farmyard manure made in a bullock yard :—

75 are water.

About 2 are solid constituents of the solid excretions.

About 8 are constituents of the solid excretions.

About 15 are constituents of the litter.

On the basis of bulk, therefore, litter is more important than anything else, although not in other respects. Its chief effect

is that it forms the humus in the soil, and therefore helps to promote tilth and to improve the water-holding capacity. Unfortunately, its change into humus is expensive to the farmer in that the organisms effecting the change take up valuable nitrogen compounds from the urine that ought to have gone to feed the crop.

THE MAKING OF FARMYARD MANURE.

The simplest case is that of manure made from fattening bullocks in stalls or covered yard where the manure is of considerable value, and where pains are commonly taken to preserve it. Of every 100 lb. of nitrogen fed to the animals, about 95 lb. pass into the manure—often about 45 to 60 lb. in the liquid and 50 lb. to 35 lb. in the solid excretions. The 45–60 lb. are in a form highly valuable to the plant. The decomposition process, however, takes rather a heavy toll, in one way or another about 15 lb., leaving 30 to 45 lb. in a form really useful to the plant. The nitrogen in the solid, and such of this 15 lb. as is not altogether lost, may at some time become useful to the plant, but it does not count for much: only the 35 to 40 lb. balance can be relied upon to yield any profit.

When, as often happens, the manure is made in open yards, the loss becomes more serious. The minimum loss of 15 per cent. is exceeded, often much exceeded, and, as always, it falls on the most valuable part of the nitrogen. It is probably not far wrong to suppose that the manure from a bullock receiving 3 lb. of cake and upwards per day is worth 15s. or more per month when made in a covered yard, but not more than some 10s. or 12s. per month when made in an open yard. For a herd of twenty bullocks the loss in manurial value through having no roof to the yard may be any amount up to £5 per month.

• It is often maintained, however, that some rain is necessary as otherwise the manure becomes too dry. While a certain amount of moistness is necessary, rain may seriously damage the manure by washing out some of its valuable constituents and by bringing about certain undesirable changes. It is probably better to keep rain away from the manure and to ensure sufficient moisture by

reducing the area over which the animals can wander, thus obtaining a high proportion of excretions among the litter. The comfort and well-being of the animals, however, must always be the first consideration. Periodically pumping liquid manure or water over the heap is not to be recommended.

STORAGE OF FARMYARD MANURE.

In the matter of storage the Northern farmer has some advantages over his colleagues in the South, one of which is that he can, as a rule, advantageously apply farmyard manure to his land in the spring. Manure made in the yards during winter can thus be hauled straight on to the land and ploughed in with reasonable certainty that this is the best thing to do. The Southern farmer, on the other hand, while he may be driven to spring applications of farmyard manure, would often obtain better results by applying the manure in the autumn. The storage of farmyard manure over the summer months thus becomes an important question.

However carefully matters are arranged, directly the manure is drawn from the yards some of its really useful nitrogen—the 30 lb. balance—begins to leak away. It forms part of the odour that gave the old farmers so much satisfaction. It enters largely into the black liquid, which, even in a well-conducted farm, is often seen draining away from the manure heap. Both smell and liquid are signs of leakage; but they do not represent the whole of the loss. It is wrong to suppose that matters can be put right by simply replacing the black liquid; its very existence is a symptom that bigger losses are taking place.

Many attempts have been made to obtain a reliable estimate of the amount thus lost. In experiments at Rothamsted the losses varied from 7 per cent. to 35 per cent. of the total nitrogen. A common loss was about 20 per cent., falling chiefly on the urine nitrogen. Assuming this latter figure were generally true—and we have no reason for supposing otherwise—our 30 lb. of valuable nitrogen would soon be reduced to little more than 10 lb., *i.e.*, 35 per cent. of the original nitrogen, or 75 per cent. of the most valuable portion, has disappeared.

LOSS IN FARMYARD MANURE.

It has often been suggested that kainit, gypsum, superphosphate or other substance added to the manure helps to reduce the loss by fixing ammonia. The processes bringing about the loss, however, are too complex to offer any reasonable expectation of the discovery of a satisfactory fixer.

It is difficult to form any estimate of the loss which occurs to farmyard manure over the whole country, but it must be considerable. Taking the present consumption of straw in the farm buildings of the United Kingdom to be about 10,000,000 tons per annum, the production of farmyard manure would be 40,000,000 tons, worth at present prices some £25,000,000 or more. The loss in making and storing the manure heap is not less, but probably more, than 20 per cent. of this, *i.e.*, more than £5,000,000 each year.

This loss cannot altogether be avoided, because it is part of the cost of the necessary decomposition of the straw, but it can be much reduced. In experiments at Rothamsted the provision of shelter to keep off some of the rain much increased the effectiveness of the heap.

Shelter can be provided in several ways. A layer of earth has proved effective, but it is not always convenient. Straw-thatched hurdles acted well in the trials. Placing the heap in a well-sheltered position is also helpful.

At present prices it is probably safe to suppose that an amount from 1s. to 5s. is added to the value of every ton of manure by providing shelter.

THE FEEDING OF CAKE.

There has been considerable discussion as to the extent to which cake-feeding adds to the value of farmyard manure. In recent experiments the additional value due to the cake was less than was expected, and the benefit of the cake was shown only in the first year, and not afterwards. The practical man, however, holds fast to cake-fed dung, and recent experiments at Rothamsted have shown a direction in which it may be superior to ordinary dung. The breaking up of the litter to form humus is brought

about by organisms which require the sort of nitrogen compounds that they would find in cake-fed dung; they would, therefore, be able to work more vigorously in cake-fed dung than in ordinary dung, and hence would tend to produce better soil conditions.

The evidence indicates that cake-feeding produces less benefit than might be expected on soils where plant food only is needed, but more benefit on soils where additional humus is necessary.

COW MANURE.

The question of cow manure is complicated by the necessity for satisfying sanitary inspectors, and by the fact that it is of poorer quality than bullock manure.

The poverty of cow manure arises from the fact that a cow secretes a considerable proportion of this nitrogen of the digested food in the milk instead of passing all of it into the urine like bullock. The urine is, therefore, weaker than in the case of bullocks, and there is a corresponding reduction in the value of the manure.

On some of the Oxfordshire farms a big covered shed is built next the cattle-shed for the storage of manure. The principle is sound, but the plan is sometimes inconvenient in execution. In Cheshire one sees good dungsteads—roofs of corrugated iron carried on stout posts, and so placed that the dung can easily be tipped underneath and then compacted. These are of great value, but care must be taken that the manure is sufficiently well compacted to prevent it becoming too dry.

Cow manure, however, presents an interesting possibility, because so much of the liquid is or can be collected separately, and this should certainly be done wherever practicable. The liquid is very valuable, containing as a rule about 18 lb. to 23 lb. of nitrogen per 1,000 gallons, besides possessing a high potash value.

A suitable dressing is 1,500 gallons per acre, and it serves excellently for seeds and as a spring application for winter oats or winter wheat. On an average each cow contributes about $1\frac{1}{4}$ gallons

of urine per day,* which is worth about 2s. 6d. per month. The difficulty at present is to apply this material.

ARTIFICIAL FARMYARD MANURE.

As the bulk of farmyard manure is litter, and the valuable part of the residue is largely made up of liquid excretions, it is not difficult for the scientific investigator to make an artificial farmyard manure from straw and artificial fertilizers. This has been done at Rothamsted, and one or two tons of the product were tried on the field. It is too early as yet to say whether the material will work out economically in practice, but the principle is sound; it consists in allowing the straw to decompose with formation of humus, and supplying the necessary nitrogen compound in the form of an ammonium salt. When the details are worked out the method may probably prove of interest in districts like the Rothings, in Essex, where quantities of straw are produced but no live stock is kept, and yet where farmyard manure ought to be used.

POSSIBILITIES OF IMPROVEMENT.

The possibilities of improving bullock manure lie in the following directions:—

1. To make it in a covered yard, having sufficient beasts to keep the manure moist.
2. To put it into the ground as soon as possible after the beasts are removed; but, if this is impossible, to make a tight clamp and provide some shelter by a layer of earth or by some other device.
3. To avoid washing by rain or exposure to weather.

The defects of the clamp, even when compacted and sheltered, are recognized, and science has not yet said the last word as to the storage of manure; but for the present it is the only practicable method.

The improvement of manure from cowsheds can be effected:—

1. By collecting the liquid separately in a cement tank.

* Both at Woking and at Gärforth, however, Collins gives 5 gallons containing 4 lb. of dry matter as the figure for the North.

2. By storing the solid in a covered dungstead, to which can also be added manure from the horses. It is necessary to compact the heap. Provision must also be made for a tank to collect drainage.

The application of the liquid to the land, however, is a difficult problem. The method of distributing the liquid over the farm by means of pipes has been tried, but has resulted in financial loss. Something can be done by delivery from carts, but the most helpful line is the use of absorbents, which is now being investigated at Rothamsted. This is an important problem, and it will grow in importance if the soiling system of keeping dairy cows develops in this country.

RETTING FLAX IN WATER.*

SOME years ago attention was drawn to a method of retting flax in water inoculated with a pure bacterial culture. This method was described by Professor Giacomo Rossi, Director of the Institute of Agricultural Bacteriology in the Royal Higher School of Agriculture, Portici, Italy, in an article entitled "The Industrial Retting of Textile Plants by Microbiological Action," in the *International Review of the Science and Practice of Agriculture* (August 1916, 1067). The process depends on the action of a special aerobic bacillus, of which the prototype is *Bacillus Comesii*. In 1915 the Société Française de Rouissage Industrial was founded to work the Rossi patent, and a factory was erected at Bonnetable in the district of Mamers, Sarthe Department, France, where flax is now retted on a large scale.

At the request of Mr. Philippe Roy, Commissioner-General of Canada in France, a visit has been paid to the Bonnetable works by Mr. Alfred Renouard, a civil engineer, who has made careful observations of all the operations and the various stages of the process, and has prepared a report which has been published in the *Weekly Bulletin Department of Trade and Commerce, Commercial Intelligence Branch, Canada* (1919, XX, No. 803, p. 1185). The bacterial ferment employed in the Rossi method is an aerobic bacillus which is capable of consuming the pectinous matter in which the fibres are embedded, but does not attack the cellulose of which the fibres are composed. There is therefore no danger of the flax being injured if the normal time for the completion of the retting is exceeded.

The method consists essentially of three stages: (1) the immersion of the flax straw in water at 82-86° F. in suitable vats; (2) the addition of a certain quantity of a culture bouillon of the

* Reprinted from *The Bulletin of the Imp. Inst.*, XVII, No. 4.

baocillus; and (3) the passage of a current of air through the water in the vats during the whole of the retting period.

The cultures are supplied from Prof. Rossi's laboratory in tubes ready for use in the preparation of the bouillon. The vats are constructed of reinforced concrete, and each has a capacity of 50 cubic metres (about 50 tons of water) and is capable of dealing with 5-5½ tons of flax straw. At the bottom of the vat and on each side is a branched pipe provided with holes, these pipes being used for the admission of air. Along the bottom and down the middle of the vat is a perforated tube of larger size for the introduction of steam to warm the water. The water enters the vat through another pipe, each vat being thus supplied with three sets of pipes, each set being controlled by a separate valve, *i.e.*, one for the air, a second for the steam, and a third for the water.

The bundles of flax straw are laid flat in the vat and placed side by side until the vat is filled. Water is then introduced, the flax being held down by wooden strips as it tends to rise above the surface. Steam is introduced to raise the temperature of the water to 82-86° F., and the culture bouillon is then added. Air is now passed into the vat from an air compressor which delivers 200 litres of air per minute to each vat. The operation is completed in 36-40 hours.

The bundles of retted flax straw are removed from the vats and conveyed to the drying ground, where they are spread out on the grass. After a few days on the grass the flax is dry and ready to be subjected to the breaking process, but in the winter or during bad weather artificial drying must be practised. At the Bonnetable works, the artificial drying is effected by spreading the damp flax straw on racks in a specially constructed drying room, and submitting it to a powerful blast of hot air.

It is stated that the cost of equipping such a retting factory is comparatively small and the method of operating is very simple. The process is more economical than the so-called hot-water retting methods, and has the further advantage that no change of water is required during the operation. After the required temperature has been reached by the admission of steam, no further heating is

necessary, as the fermentation generates sufficient heat to maintain the temperature. The water which is run off from the vats after the retting is finished is of a pale yellowish colour and is almost free from odour.

After examining the different grades of flax produced at Bonnetable, Mr. Renouard considers that the Rossi process can furnish the best possible results from flax straw of any kind which may be treated. Moreover, as the process can be checked at any moment, the action can be so controlled as to give products answering to all the requirements of flax spinners. The yield of fibre amounts to about 20 per cent. of the weight of the flax straw.

It is mentioned that the Rossi retting process can also be applied to hemp and ramie, and that, according to tests made by Prof. Rossi, it appears that Sisal leaves when crushed and retted by this method furnish a good, white fibre of better quality than that produced in the usual way.

In connection with this microbiological retting of fibres, it may be mentioned that, according to the *International Review of the Science and Practice of Agriculture* (October 1917, 1417, and April 1919, 477), Carbone and Tombolato have isolated an anaerobic bacillus from the mud of some of the Bologna hemp retting pits, which has been termed *Bacillus felsineus* and is capable of retting hemp and other textile plants. This bacillus has been found not only in the mud of hemp pits in the province of Bologna, but has also been isolated from the mud of two retting pits of Rovigo and from certain retting products of the province of Naples, and it seems highly probable that it is the active agent in the retting of Italian hemp. In conjunction with *Saccharomyces*, the bacillus rets hemp stalks in less than 2½ days at a temperature of 98-99° F. and has been extensively tested in the Italian hemp districts. It has been shown by Carbone that *Bacillus felsineus* is capable not only of retting hemp, but also of retting flax, ramie, nettle, *Furcraea*, *Sansevieria*, *Agave* and many other plants. It always produces a very rapid retting and furnishes fine, white, well-separated fibres.

A NEW THEORY OF THE ORIGIN OF SEA ISLAND COTTON.*

SEA ISLAND COTTON is generally considered to have originated from the West Indian perennial cotton (*Gossypium barbadense*).

At a meeting of the Manchester Literary and Philosophical Society held in 1830, Mr. John Kennedy, one of the two founders of the present firm of McConnel & Co., Ltd., read a letter (from which an extract is given below), which had appeared previously in the *Charlestown Courier* (South Carolina).

The writer of the letter (Thomas Spalding of Darien, Georgia) states as follows: "The Sea Island cotton was introduced directly from the Bahama Islands into Georgia. The seed, as I have been often informed by respectable gentlemen from the Bahamas, was in the first instance procured from a small island in the West Indies, celebrated for its cotton, called Anguilla. The winter of 1786 brought several parcels of cotton seed from the Bahamas to Georgia; among them (in distinct remembrance upon my mind) was a parcel to the Governor Tatnall of Georgia, from a near relative of his, then Surveyor-General of the Bahamas, and another parcel at the same time was transmitted by Colonel Roger Veisall, of Exuma, who was among the first, if not the first successful growers of cotton, to my father Mr. James Spalding, then residing on St. Simon's Island, Georgia. I know my father planted his cotton seed in the spring of 1787, upon the banks of a small rice field on St. Simon's Island. The land was rich and warm, the cotton grew large and blossomed, but did not ripen to fruit; it, however, ratooned or grew from the roots the following year. The difficulty was now over; the cotton adapted itself to the climate, and every successive year from 1787 saw the long staple cotton extending itself along the shores of Georgia and into South Carolina."

* Reprinted from *The Agricultural News*, Barbados, Vol. XIX, No. 408.

During the progress of investigations, on the mode of inheritance of characters in cotton, certain facts have come to hand which throw considerable light on the way in which Sea Island cotton probably originated.

Briefly, the facts suggest that Sea Island cotton originated from a natural cross between a glabrous broad-leaved West Indian Native, with botanical affinities to *G. brasiliense*, and some variety of American Upland.

We may accept, as substantially correct, the statement of Spalding that the original Sea Island cotton seed came from Anguilla *viâ* the Bahamas. In what characters does Sea Island cotton differ from indigenous West Indian Native, and by what means were the new characters acquired? It will, perhaps, be convenient to summarize the salient differences between Sea Island, Upland, and West Indian Native in tabular form:—

	Sea Island	Upland	West Indian Native
Habit	Sympodial	Sympodial	Monopodial
Resistance to leaf-blister mite	Susceptible	Susceptible	Practically immune
Resistance to cotton worm	Comparatively resistant
Leaf	Glabrous	Hairy	Glabrous
Petal spot	Present	Absent	Present or absent
Pits in boll	Sunken	Superficial	Sunken
Boll loculi	3-4	3-5	2-4
Lint	40-55 m.	20-25 m.	30-35 m.
Seed	Black with green tuft	Woolly	Black with green tuft

It will be seen that while Sea Island cotton resembles the coarse-leaved West Indian Native in many of its characters, it differs from it in being extraordinarily susceptible to the attacks of leaf-blister mite and cotton worm, and in its annual or sympodial habit—all of which characters are possessed by Upland cottons. Planted anywhere in the West Indies, and left to itself, Sea Island cotton could certainly not maintain itself. It would certainly succumb to the prevailing climatic conditions and to infestation with leaf-blister mite. Its behaviour is that characteristic of an exotic plant.

Experiments have shown that all West Indian Native cottons breed true to the monopodial habit, *i.e.*, all nodes on the main axis, up to about thirty, produce only vegetative branches. The combination of monopodial habit with great vegetative vigour confers on these types their perennial character. Furthermore, Sea Island cotton breeds true to the sympodial habit, the first fruiting branch being put forth at nodes 8-14. In thousands of plants of both Native and Sea Island cottons there has never been the slightest tendency observed for the Native to develop the sympodial, or for Sea Island to take on the perennial habit. It may be remarked at this point that experiments were carried on in Barbados for many years, which had for their object the production, by gradual selection, of Sea Island from Native. Needless to say, these experiments were doomed to failure from the very outset. Selection by itself will not change perennial cotton into annual.

When the monopodial Native is crossed with the sympodial Sea Island, or Upland, the F_1 generation is sympodial. This was found to be the case in Leake's experiments with the corresponding morphological forms found in Asiatic cottons.

In the second generation segregation occurs into monopodial and sympodial, though there is no strict line of demarcation. The majority of the plants, however, are sympodial and annual in habit, and breed true to this character in this generation cultures.

Only about one plant in 300 is really monopodial. In a cross between a coarse-leaved, glabrous West Indian Native and Upland, the first generation plants were, morphologically, almost indistinguishable from Sea Island. They possessed the sympodial habit and susceptibility to leaf-blister mite of the Upland, combined with those morphological characters of the West Indian type which cause it to resemble Sea Island. In addition to this, the lint was over 40 mm. in length, and exceedingly fine and silky in texture, thus closely approaching Sea Island in character.

In the second generation several plants were noted possessing the same general likeness to Sea Island.

We may thus hypothetically reconstruct what happened when West Indian Native seed was introduced into the United States.

The first year of growth showed nothing but perennial (monopodial) plants which did not arrive at maturity. If we postulate natural crossing to have taken place when they flowered the following year between these types and neighbouring Upland cottons, the natural hybrids, being early maturing and long-linted, would attract immediate attention, and the seeds from them would be carefully preserved and planted. Once the sympodial habit was acquired selection of the most promising plants could quite conceivably have resulted in the development of the Sea Island variety as it is at present constituted.

While this hypothesis has more intrinsic probability as an explanation of the origin of Sea Island cotton than any other theory yet advanced, it must be admitted that the actual reconstruction of Sea Island cotton by this means has not been accomplished in recent practice. It must be borne in mind, however, that there exist many different strains of West Indian Native which agree in being broad-leaved, glabrous, tufted-seeded, etc., but differ in other respects. The synthesis of Sea Island cotton could probably only be effected as a result of the segregation of some rare gametic combination derived from a cross between a special form of West Indian Native and perhaps also a special form of Upland.

Notes

NATALITE.

IN South Africa pioneer work has been done in the production of motor fuel known as Natalite by distillation of the molasses from the sugarcane. It is by no means a perfect fuel for internal combustion engines and the difficulty so far has been to discover a powerful denaturant that is both cheap and plentiful. In 1919, the Advisory Board of Industry and Science recommended that the manufacturers of Natalite should be given permission to manufacture a certain quantity of the spirit, using one per cent. of pyridine as a substitute for the costly wood naphtha then used. But this recommendation was not accepted. The "Industrial South Africa" now reports that in recent months a new denaturant has been found in a petroleum product known as Simonsen and the authorities have permitted its use in the place of wood naphtha. It is stated that this product is very efficacious and its presence with pyridine in industrial alcohol fully meets the desired end. In view of the urgent need for the production in large quantities of cheap motor spirit this discovery is of considerable interest. [WYNNE SAYER.]

* * *

GOAT'S RUMEN FOR DIALYSIS.

WITH the taking up of the work on protein by the Agricultural Chemist to the Government of the United Provinces, much difficulty was experienced in dialysis on account of shortage in the supply of parchment.

Our idea, therefore, was to find out something indigenous that could advantageously be used at the present abnormal time.

Trials were made with the bladders of different animals, but these too did not prove satisfactory. Some of these were ridiculously small, while others were found unsuitable for extensive trials owing to religious susceptibility of the laboratory servants and to difficulties in obtaining them.

Working with the different parts of a goat's skin the idea struck me that a trial should be made with the rumen.

Most encouraging results were obtained with the preliminary tests.

Goats' rumina are plentiful in India and could be had in any number from butchers at a cost of only about an anna each.

Preparation of these for dialysis, as has been described below, does not present any extraordinary difficulty. Some of these are big enough to hold a single charge of more than five litres of liquid; moreover, they act very quickly. In actual work, soluble salts begin to pass out within a few seconds. When running water is used, practically all saline matter is got rid of in about 12 hours.

Too much care cannot be taken to keep the thing perfectly sterile during the whole process.

Preparation. The rumina as obtained from the butchers are carefully cleaned and thoroughly washed. Air is next pumped in through the œsophageal orifice which is then carefully tied with a piece of string, and the rumina, in the inflated condition, are hung up in the sun for several hours to dry. When perfectly dry, air is driven out, and the rumina are soaked in milk of lime (prepared from best lime obtainable) and kept immersed in it, with occasional turning over, from 8 to 10 days. These are then taken out, thoroughly washed and carefully scraped with a blunt spatula. These are then again thoroughly washed and soaked for two days in a 0·5 per cent. acetic acid solution. The acid is then washed out and the rumina are fit for use as dialysers. [S. C. BANERJI.]

* * *

PROSPECTS OF THE WORLD'S SUGAR MARKET.

THE "Hamb Borsen-Halle," of June 25th, 1920, contains a most interesting survey of the position and prospects of the world's sugar

market, from which we quote as follows : All over the world there is, as heretofore, still to be noted a great demand for sugar which is very far from meeting with anything like an adequate supply. In those countries where the authorities have fixed the prices, the latter have been subjected of late to a further increase or a considerable increase of the prices is in contemplation in regard to the new crops. While in the countries where the sugar trade had been released from control, the prices have, as a natural result of the great preponderance of demand over supply, likewise gone up to a large extent.

During the first years of the war, the tremendous falling-off in the beet-sugar production in Europe was to some extent compensated for by an increased production of Colonial cane sugar. But as recently as last month it was found necessary once again to reduce the estimates of Colonial cane sugar ; from the end of last year, by which time the production had been estimated at 245½ mill. zentner, it had to be reduced by not less than 11½ mill. zentner, thus showing the estimate to amount to merely 234 mill. zentner. In this way the hope of at least partly counterbalancing the great falling off of the beet-sugar production has disappeared, especially as it would appear that the latter, too, has been greatly overestimated, and the figures as estimated at the end of last year would, according to the revised returns, have to be reduced by exactly 18 mill. zentner, so that one would have to count the estimated beet-sugar production as merely 69 mill. zentner.

By a remarkable coincidence, both in regard to beet as well as cane-sugar production, it was the two most important countries—Germany and Cuba—which were mostly responsible for the necessity of revising the figures of the estimated sugar crops, which only a few months ago seemed perfectly justified. The causes which contributed to these regrettable disappointments are to be found, as regards Germany and the other European countries concerned, in the abnormal weather conditions of last autumn, the continued coal famine, and, last but not least, the lack, as a result of the political unrest, of skilled labour and the reduced productivity. In Cuba, too, the weather conditions did not come up to expectations, and

labour troubles also came into play here. At any rate, it may justly be assumed that from the very beginning, whether for speculative reasons or otherwise, a considerable overestimate of the probable cane-sugar production has taken place.

However it may, it appears that the trading year ending 31st August, 1919-20, has proved disappointing all along the line, and instead of relieving the general sugar shortage it has rendered it still more difficult, as will be seen from the following figures (these were produced in million zentners):—

	1919-20	1918-19	1917-18
Beet sugar in Europe	55·75	74·75	84·85
Beet sugar in America	13·35	13·35	13·90
Total production of beet sugar ..	69·10	88·10	98·75
Total production of cane sugar (including Spain)	234·15	239·50	246·30
Total world production	303·25	327·60	345·05

Even though the above figures still but represent estimates and cannot claim to be regarded, nor should be regarded, as exact, nevertheless, they graphically depict the general position of the world's sugar supply during the years following the official conclusion of the world war. Demand and supply exceed the production by innumerable million zentners, and under these circumstances sugar is likely to remain for some years to come a rare product, and, as compared with the pre-war low prices, will be extraordinarily dear, even when the exchange in the various countries will gradually have reassumed normal conditions. [*Production and Export*, July 1920.]

* * *

THE USE OF TRASH IN THE CULTIVATION OF RATOON CANES.

EXPERIMENTS to test the value of piling the trash on the banks between rows of ratoon canes have been carried out on a plantation in Hawaii, the results of which are reported in "Facts about Sugar," January 24, 1920.

In one experiment two varieties of cane were treated, namely, H. 109 and D. 1135, both as second ratoons.

Immediately after the cane was cut, the trash was piled around the stool, and not covered with soil in any way. In the no-trash control plots the trash was removed completely. In all other respects the plots received identical treatment.

As a result both varieties of cane produced less cane and less sugar from the trashed plots. The difference in sugar was caused, not by any very great difference in weight of cane produced, but by a distinct difference in the quality of the juice. In all cases the juices from the trashed plots were poorer than those from the no-trashed plots.

From these results it would seem that trash, when not buried, is not as valuable as had been supposed, at least under Hawaiian conditions where irrigation is extensively employed. Under such conditions the particular value of trashing cane fields as recognized in West Indian cane cultivation would be minimized. The value of the trash piled on the rows, as is the usual custom in the West Indies, is that of a mulch for conserving soil moisture and keeping down the growth of weeds. As a fertilizer its value is not great. [*Agricultural News*, dated April 3, 1920.]

* * *

SEED-RATE OF SUGARCANE.

WHEN one talks of agricultural improvement to an average cultivator the latter at once takes it to mean greater production and an increased yield per acre. But a higher gross return does not always result in an increased net profit, as the latter very much depends on the initial outlay. To reduce the cost of cultivation without in any way sacrificing the outturn and to obtain a heavier yield without in any way materially increasing the cost of cultivation, do form the two chief methods of increasing the net returns from any crop. It is intended in this short article to show how the former way is possible and practicable in the case of one item in sugarcane cultivation, *viz.*, seed rate.

Sugarcane is one of the most important irrigated crops of the Bombay Presidency and with the opening of new canals its cultivation is extending rapidly. The local system of cultivating it is too costly and too wasteful of labour and capital and very often not sufficiently paying. The new Manjri method is a distinct advance on the local system in point of economy of labour and capital required as bullock power can to a large extent be substituted for manual labour and the operations done more economically and in time.

Seed-rate is one of the costly items in cane cultivation, and in years following a severe drought enough sets are difficult to obtain, and even if available do sell at abnormally high rates, as was the case in the last planting season. Thus any saving effected in this connection is useful.

The local practice is to plant 16,000 to 18,000 sets per acre; in some cases sets from whole canes are used and in others only the top sets; the seed-rate, however, being the same in both cases. The sets from an average *Pundia* cane are usually each about one foot in length (each set possessing 3 eye-buds). Thus when they are planted end to end, as is usually done, as many sets are required as there are linear feet in the rows to be planted. In the local method cane is planted in furrows two and a half feet apart, and thus the total linear length of the rows in one acre is 17,424 feet, demanding on an average 16 to 18 thousand sets per acre, a slightly heavier or smaller seed-rate being used according to the length of the sets. When the new Manjri method was introduced, the distance between two rows was doubled and hence the linear length of rows of cane actually planted came to be only 8,712 feet. If sets are planted end to end, only 8,000 to 9,000 sets would suffice for an acre, which would be half of that used formerly. Thus cultivators were in the beginning rather shy to take up this method and its seed-rate, and even when some did so they followed everything but the seed-rate, the tendency being always towards a heavier one. The experience at Manjri for the last five years has, however, proved beyond all doubt that the reduced seed-rate does not at all adversely affect the tonnage.

But this fact suggested a series of experiments to determine the optimum seed-rate for *Pundia* cane in medium black soils of the Deccan and the conclusions drawn below are mostly based on work done in 1917-18 and given on page 25 of Bulletin No. 90 of the Department of Agriculture, Bombay Presidency, and quoted below in part for ready reference.

Statement.

Year	No. of sets per acre	No. of eye-buds per acre	No. of shoots germinated per acre	No. of plants on 2-8-17	Tillers produced	Ratio of plants after tillering to plants germinated	No. of canes obtained per acre	Tillers which matured	Percentage of tillers matured	Ratio of mature plants to germination	Weight of canes per acre	Weight per cane	Weight of <i>gwt</i> per acre	No. of canes per eye-bud
1917-18	6,000	18,000	8,660	37,765	29,205	4.4	25,935	17,375	59.4	3.0	99,617	3.8	142,78	1.4
1917-18	9,000	27,000	13,500	40,830	27,630	3.9	22,302	9,222	33.0	1.7	100,785	4.5	13,582	0.8
1917-18	12,000	36,000	20,880	39,245	18,365	1.9	23,971	3,091	16.8	1.1	98,134	4.1	13,807	0.6

The following remarks on the statement are tentative until further data are available. Yet the figures are very illustrative. The seed-rates tried were 6,000, 9,000, and 12,000 sets per acre. The germination obtained was 47.5, 48.9, 58.0 per cent. respectively, giving thus an original stand of sprouts at 0.98, 1.5, and 2.4, respectively, per linear foot in the three cases. This shows that there was a distinct start in favour of the heavier seed-rates. The cultivator usually believes that a heavy stand at start means a heavy outturn in the end; we shall see if facts bear this supposition out.

It is the natural tendency of cane to produce underground branches or tillers as they are usually called. This characteristic is more marked with some and less in other varieties, generally the thin and reed-like varieties tillering more profusely than the thick types. The local cane, *viz.*, *Pundia*, is, however, a heavy tillerer and, given proper conditions of space, aeration and soil-moisture and heat, it is not uncommon to count 25 to 30 canes in one stool. In the reduction of seed-rate it is this factor that is taken advantage

of, the aim being to put in the minimum seed-rate and secure the maximum number of mature canes.

Tillers begin to appear after about six weeks from the date of planting and the process goes on up to about August, when the main growth shades the ground and crowds out any tillers that may try to come up.

The counting in August gave per linear foot a stand of 4.3, 5.6 and 4.5 shoots, respectively, and thus improved the original stand by 3.35, 4.1 and 2.1, respectively, in the three cases, the smaller seed-rate of 6,000 sets having had more tillers than that of 12,000. In fact "suckering depends largely upon the room, the greater the distance apart the greater the number of suckers."

Of these if we calculate how many did actually develop into mature canes (supposing that all the mother sprouts grew into ripe canes), we find a larger percentage of these with the less seed-rate, there being a complete growth of 59.4, 33.0 and 16.8 per cent., respectively.

Following the matter further it will be seen that, at the time of harvest, for every linear foot the three seed-rates gave 2.97, 2.52, and 2.75 number of canes. The weights of individual canes were on an average 3.8 lb., 4.5 lb., and 4.09 lb., respectively, *i.e.*, the yield in cane per linear foot in the row was 11.32 lb., 11.52 lb., and 11.25 lb. in the three cases, the tonnage varying in the same proportion. The small variation in the outturns is well within experimental error.

It is possible to estimate a general principle from the above data. With an original stand of one shoot per linear foot in rows opened five feet apart, the outturn obtained is satisfactory, and thus it would be enough if a germination of 8,712 eye-buds is secured per acre. Taking the average germination of 70 per cent., and making allowance for the eye-buds that fail to germinate, a seed-rate of 12,445 buds or 4,148 sets of three eye-buds each should suffice for an acre. Experiments are in hand at the Manjri Farm in that direction and a seed-rate of 4,500 sets per acre is being tried.

This reduction in the seed-rate would mean a saving over the local seed-rate of at least Rs. 58 per acre at Rs. 5 per thousand sets,

a rate common in normal years, or Rs. 140-6-0 or more at the rates current in the last planting season of 1920.

Then why is a heavier seed-rate put in by the cultivator? The first reason is his diffidence in the final outturn; secondly, the local method of planting in beds having furrows only 30 inches apart uses up a large seed-rate; thirdly, the absence of selection of sets from the top third of canes only, the lower part of cane giving always a very poor germination (see Mr. Mahajan's article in the *Poona Agricultural College Magazine*, Vol. VII, No. 2, page 93); fourthly, improper planting of sets without seeing whether the eye-buds are all placed to sides brings down the germination figure considerably (see Leaflet No. 8 of 1915, of the Bombay Agricultural Department); fifthly, improper tillage and bad irrigation which retard and often-times seriously affect the germination; sixthly, the planting is often much delayed by the cultivators up to late in summer when the cane-borer is active and kills many of the shoots and thus reduces the number of useful sprouts.

If proper care is taken in the selection, planting, and after-care of the sets and the planting done in the proper season, a good germination of at least 70 per cent. may easily be secured. [V. S. Kulkarni in the *Poona Agric. College Magazine*, Vol. XI, No. 4.]

* *
* *

TREATMENT OF WOUNDS ON TREES.

THE "Journal of the Jamaica Agricultural Society," December 1919, has a note on the treatment of the wounds made after pruning trees. There are many different preparations which have been recommended in different parts of the world for dressing the cut surfaces made in pruning trees. The wood of these wounds, if left untreated, especially in the case of trees with soft wood, like that of cacao, easily decays, and affords entrance to insect and other pests. The Supervising Agricultural Instructor, Mr. Cradwick, in a long experience in Jamaica, has found that common gas tar is the best and by far the cheapest preparation for the purpose. But it must be used properly, not merely daubed on, but painted on and rubbed well in, as if polishing a piece of furniture. The wound is thus

made water-proof and disinfected. [*Agricultural News*, dated April 3, 1920.]

* *

NEW IMPLEMENTS AT THE ROYAL SHOW.

THERE is no longer any question that the British farming community, which has in the past always been considered so retrogressive, is now being converted whole-heartedly to the more general employment of machinery for all purposes in connection with cultivation. Nothing was more striking in the Royal Show (the 79th of its type which was recently held at Darlington) than the great interest that was shown in the large numbers of new types and classes of machinery designed essentially for labour saving and for more intensive cultivation. It is not surprising to find a fair number of tractors exhibited, since these are becoming more and more popular among farmers through the whole world, and these are mostly similar to those which were entered for the trials at Lincoln. Several examples of Fordson's were to be seen as well as Austin's, these two being perhaps the most popular classes in use, probably owing to their relatively low price. The Blackstone tractor was of special interest, as it is the only type which will run directly on kerosine, all the others having to start on petrol. This is accomplished by having a compressed air self-starter, and another feature of interest in this machine as well as in that known as the Martin, built by the Martin Cultivator Co., of Stamford, is that chain track construction is adopted.

Many of the leading American tractors were to be seen besides the Fordson and some of them are listed at a very reasonable price. For instance, the Emerson with a 20 h.p. motor is sold at £495, whilst the Titan is £437 and the International £280. One of the best known and most successful British tractors is the Sanderson, built at Bedford, and fitted with a 25 h.p. engine, having three speeds forward and a reverse. It has one or two specially useful features including a winding drum, whilst the provision of a tool box in front of the radiator forms a protection, which is specially useful when the

tractor is driven by an unskilled man. Needless to say, these machines are arranged to act as stationary engines when required, driving any of the usual classes of farm machinery or, if necessary, centrifugal pumps, dynamos, etc. Even the Fordson, which is the cheapest tractor to be obtained, has provision for this work, being fitted with a detachable pulley. A new and apparently useful self-contained motor plough is exhibited by John Fowler and Co., fitted with a small two-cylinder engine, the total price being £360. This is, however, only a light machine and must not be compared with some of the more heavily built tractors. It is interesting to note that the well-known pump manufacturing firm, Worthington Simpson, Ltd., are now building a motor driven tractor, but it was not completed in time to be exhibited at the Show.

Another well-known firm to enter this field of construction is Peter Brotherhood, Ltd., who show for the first time a powerful heavily built tractor fitted with a new engine of 35 h.p. of the four cylinder electric ignition type with cylinders $4\frac{3}{4}$ inches bore and $5\frac{1}{2}$ inches stroke, and running at about 900 r.p.m. This is quite novel and is worth describing in detail. Instead of the ordinary side by side valves, overhead valves are fitted as in some types of 1920 motor cars operated by means of long vertical push rods. The pistons are made of aluminium which is entirely new for such work, although it is being more and more adopted in internal combustion engines for other purposes, and the motor is designed to start on petrol and run continuously on kerosine. The only criticism one can make is that the engine looks too high class for its work. All the parts are totally enclosed, a cover being fitted over the overhead valves, and the ball bearings are used throughout. There is no doubt this is an excellent machine, but its price is probably high. It weighs about $2\frac{1}{4}$ tons and has a draw bar pull on high gear of 2,800 lb.

In view of the increasing use to which stationary oil engines are now being put on farms and plantations, it was not surprising that several of the latest designs were exhibited. Perhaps the most interesting were the Blackstone and the Crossley engines, both of the horizontal types with all the new features which were brought out by these two firms a short time ago. Both engines start up from

cold without any previous heating and will run on the heaviest oil with a fuel consumption of about half a pound per b.h.p. hour. The Blackstone engine shown is one 75 h.p., whilst the Crossley set develops 40 h.p. and there is little question that this class of motor will become increasingly popular for ordinary stationary work.

As a contrast the Vickers Pettets semi-Diesel vertical engine represented quite a different type, two of 35 h.p. being exhibited of the latest design. Another exhibit of considerable interest by Pettets was a series of their Petter Junior two-stroke oil engines which are specially adapted for use in India in connection with pumping and lighting sets being built in sizes up to about 8 b.h.p. and running on paraffin. An application of one of the smaller sizes—a 2½ h.p. set—which should be of considerable interest in India is its use for driving a very heavy roller. The drive is taken through a belt and the roller can be controlled very simply and easily, a wheel being fitted for steering whilst there is also a foot brake and a belt lever for use when starting and reversing. Another motor driven roller very useful for road and similar purposes is the Barford and Perkins which has already been used in India. Two types are available, one weighing 12 and the other 10 tons when empty, whilst in addition two tons of water ballast can be added. They are driven by means of ordinary electric ignition motors started on petrol and running on paraffin.

One of the greatest novelties was an entirely new motor windlass system for ploughing and cultivating which has been brought out by J. and H. McLaren, Ltd., of Leeds. It is designed essentially for cultivating areas of moderate dimensions. The principle is new as the machine consists of a four cylinder engine, the power from which is taken to a large windlass mounted on the chassis. The machine itself remains stationary during operation and draws the plough or cultivator over the land, which method, it is claimed, gives a higher efficiency than with the ordinary system of motor tractors or self-contained motor ploughs. The machine is mounted on four wheels and can be used for ordinary traction if required. It looks a powerful, well-built plant and the motor is, of course, provided with the usual belt pulley for driving other machines when needed.

A notable feature of the Show was the enormous space occupied by the Agricultural and General Engineers, Ltd., the combination of eleven of the largest agricultural and engineering firms which was effected a few months ago. This concern has just taken very large London show-rooms and headquarters in Kingsway, London, where the whole business will be centralized. It is thought that by this concentration on the commercial side very great economy will be effected and that, in the agricultural engineering industry, Great Britain, will, therefore, thus be enabled to meet any competition that may arise in the course of the next few years. [*Englishman*, dated 7th August, 1920.]

* * *

COTTON GROWING IN MESOPOTAMIA.

IN view of the present scarcity in the supply of cotton, the attempts now being made to establish cotton growing on a large scale in Mesopotamia are of particular interest. Cotton has been grown in Mesopotamia from very ancient times and is still cultivated in small quantities by the Arabs in conjunction with food crops along the banks of both the Tigris and Euphrates. The fibre is used locally for spinning and as a stuffing material for pillows and mattresses. The country possesses a soil and climate favourable to the production of large yields of excellent cotton and in course of time it should add materially to the world's supply.

Since 1917 experiments have been conducted by an expert from the Indian Agricultural Service with a view to discovering the most suitable kinds to grow, and the results of the work done in this connection and the prospects of establishing a cotton growing industry are fully dealt with in the "Bulletin of the Imperial Institute," (Vol. XVIII, No. 1, January-March 1920). So far, American types of cotton seem to be the most suitable for cultivation in Mesopotamia. The members of a deputation of the British Cotton Growing Association, which visited the country towards the end of last year, were very favourably impressed with its possibilities for cotton production.

The acreage which will eventually be planted with cotton in Mesopotamia will depend on the quantity of labour available and the area on which a perennial supply of water can be guaranteed. It seems likely that a total of 150,000 to 200,000 acres could be cultivated annually by the existing population if the necessary facilities, in regard to agricultural machinery, transport, etc., were provided. At a low estimate this area should produce from 15 to 20 million pounds of cotton yearly.

PERSONAL NOTES, APPOINTMENTS AND TRANSFERS, MEETINGS AND CONFERENCES, ETC.

WE are indebted to Mr. A. C. Dobbs, Director of Agriculture, Bihar and Orissa, and Mr. R. G. Kilby, C.I.E., I.C.S., District Magistrate and Collector, Darbhanga, for the note on the late Mr. Howlett appearing in this issue.

* * *

MR. W. McRAE, M.A., B.Sc., F.L.S., Officiating Imperial Mycologist, Pusa, has been made substantive *pro tempore* in that appointment, *vice* Dr. E. J. Butler, M.B., F.L.S., on deputation, with effect from the 22nd September, 1920. Mr. McRae has also been appointed substantively *pro tempore* Joint Director of the Agricultural Research Institute, Pusa, from the same date.

* * *

MR. M. WYNNE SAYER, B.A., Supernumerary Agriculturist, Pusa, has been appointed to officiate as Imperial Agriculturist, Pusa, during the absence on deputation of Mr. G. S. Henderson, N.D.A., N.D.D.

* * *

MAJOR W. R. G. ATKINS, D.Sc., has been appointed Indigo Research Botanist in the Imperial Department of Agriculture in India, with effect from the 2nd October, 1920.

* * *

MR. R. C. BROADFOOT, N.D.A., Superintendent, Central Farm, Coimbatore, has been appointed to act as Deputy Director of Agriculture, VI Circle, Madura.

MR. D. ANANDA RAO, B.Sc., Acting Professor of Agriculture, Agricultural College, Coimbatore, has been appointed Acting Professor of Agriculture and Acting Superintendent of Central Farm, Coimbatore.

* * *

MR. F. T. T. NEWLAND, Government Agricultural Engineer, Madras, has been granted an extension of privilege leave for two months.

* * *

MR. W. M. SCHUTTE, A.M.I. MECH.E., M.R.A.S.E., Agricultural Engineer to Government, Bombay, has been granted combined leave for three months. Mr. C. G. Paranjpe officiates.

* * *

MR. A. D. MCGREGOR, M.R.C.V.S., Offg. Superintendent, Civil Veterinary Department, Bengal, has been granted combined leave for six months.

* * *

MR. M. M. MACKENZIE, Superintendent of the Sipaya Farm, has been granted privilege leave for one month and seventeen days.

* * *

CAPTAIN U. W. F. WALKER, on being appointed to the Indian Civil Veterinary Department, has been attached to the office of the Chief Superintendent, Civil Veterinary Department, Punjab, for training.

* * *

MR. J. ST. C. SAUNDERS, I.C.S., has been appointed to hold charge of the offices of Director of Agriculture and Registrar of Co-operative Societies, Burma, as a temporary measure, during the absence, on combined leave, of Mr. C. R. P. Cooper, I.C.S., or until further orders.

* * *

MR. C. J. N. CAMERON, M.R.C.V.S., D.V.H., Third Superintendent, Civil Veterinary Department, Burma, has been granted combined leave for one year, with effect from the 8th August, 1920.

MR. A. G. BIRT, B.Sc., Deputy Director of Agriculture, Assam, has been granted an extension of furlough for fourteen days from the 23rd October, 1920.

* * *

MR. J. S. GAREWAL, M.R.C.V.S., has been appointed Superintendent, Civil Veterinary Department, North-West Frontier Province.

* * *

THE Mycological, Entomological, Chemical and Bacteriological Sectional Meetings of the Board of Agriculture in India will be held at Pusa on the 7th February, 1921, and following days.

* * *

THE eighth annual meeting of the Indian Science Congress will be held in Calcutta from 31st January to 5th February, 1921.

HIS EXCELLENCY THE RIGHT HONOURABLE THE EARL OF RONALDSHAY, G.C.I.E., Governor of Bengal, has consented to be Patron of the meeting, and the Hon'ble Sir Rajendra Nath Mookerjee, K.C.I.E., will be its President.

The Sectional Presidents will be :—

Agriculture and Applied Botany. Mr. S. Milligan, M.A., B.Sc., Agricultural Adviser to the Government of India, and Director, Agricultural Research Institute, Pusa.

Physics and Mathematics. Mr. J. H. Field, M.A., B.Sc., Director, Aerological Observatory, Agra.

Chemistry. Dr. H. E. Watson, Indian Institute of Science, Bangalore.

Botany. Professor Birbal Sahni, Punjab University, Lahore.

Zoology and Ethnography. Dr. F. H. Gravely, Superintendent, Government Central Museum, and Principal Librarian, Connemara Public Library, Madras.

Geology. Professor D. N. Wadia, M.A., B.Sc., Prince of Wales College, Jammu.

Medical Research. Lt.-Col. J. W. D. Megaw, M.B., I.M.S., Principal and Professor of Pathology, King George's Medical College, Lucknow.

Reviews

Cow-Keeping in India.—By ISA TWEED. Fourth Edition.
(Calcutta : Thacker, Spink & Co.) Price, Rs. 7-8.

THIS is a new edition of a well-known work largely relied on in the past by private owners of dairy cattle in India. The book does not pretend to deal with Indian dairying as an industry, but it gives sound practical advice and should be of assistance and interest to all concerned in dairy farming in this continent. After dealing briefly but accurately with the various breeds, or so-called breeds, of dairy cattle in India, the author goes on to give advice concerning the purchasing of cows, and follows with a chapter on the good points of a dairy cow. The next chapter deals with feeding, and here perhaps the author does not sufficiently impress on his or her readers the paramount importance in India of the growing of fodders specially suitable for milch cows. Compared with world conditions purchased fodder in India is invariably very expensive whereas the concentrates are comparatively cheap.

Chapter VI of the book deals with housing and utensils, and here the details given of buildings do not agree with the most modern ideas as to the design and construction of cow-sheds for large numbers of animals in India.

We do not at all agree with the recommendation in Chapter VIII that cows should be bathed once or twice a week in the hot weather and monthly in the cold season. The cow-owner in, say, Peshawar or Quetta, who attempted to bathe his cows in the middle of winter would, we think, only do so once.

In dealing with breeding bulls and bullocks, the author quotes various authorities and generally follows sound lines, and

the book is a really useful reference manual in regard to the serving of cows, barrenness in cows, determination of age of cattle, rearing of calves, castration of male stock and the treatment of cows during and after parturition.

A great deal of sound information is given concerning the composition and treatment of milk, cream, butter, *ghi* and native cheese on a small scale.

The work contains extracts from the published opinions of various so-called experts on dairy matters, some of which appear to have been written many years ago, and consequently are somewhat out of date in the light of current experience.

Book II is a store-house of useful information concerning the diagnosis and treatment of cattle diseases.

The illustrations are poor, being evidently reproduced from wood blocks. Surely the publishers could have given the public reproductions of photographs of actual animals in illustrating the various breeds. [Wm. S.]

* * *

Charcoal as a Wonderful Fertilizer —By G. B. SET, B.A., F.R.H.S.,
Ivy Nursery Gardens, Calcutta.

THE author has found that the addition of charcoal to the soil greatly helps the germination of vegetable and flower seeds. Cuttings also strike very readily in a soil containing charcoal. Again, such plants as violets and chrysanthemums, which ordinarily do not thrive during the rains in Lower Bengal, continue to grow with astonishing rapidity when charcoal is mixed with the soil. Roses, geraniums, verbenas, lavenders, etc., are protected from the effects of heavy showers, and vegetables are found to grow with exceptional vigour, yielding crops larger in amount and better in quality when charcoal is present in the soil. In the case of winter annuals, the flowers appear earlier and possess more vivid colours. Similarly, fruit grafts are also much benefited when a moderate amount of charcoal is maintained in the soil.

The most interesting experiment conducted by the author was the one with a mango tree. This tree, while having a healthy and

widespread growth, used to bear a very poor crop of fruits. Various manures had been applied in previous years, but these had failed to produce any effect. When, however, the ground near the roots was dug up with special care to avoid injury to the primary roots, and the excavation filled up with manured soil mixed with charcoal, there was a marked improvement. A crop of 670 ripe mangoes was obtained as against 30, the average yield of the previous six years.

But while the experiments performed by Mr. Set are of great interest and deserve attention, the same cannot be said of the "explanations" advanced by him as to the function of charcoal in the soils. His arguments do not appear sound. For example, in accounting for the production of vividness of colours of flowers, he states that charcoal "possesses greater efficiency in carbon assimilation" and that "by a complete adsorption (*sic*) of sunlight, the transmission of the sun's full energy to the protoplasm is obvious and distinct."

In our opinion the beneficent action of charcoal is mainly to be attributed to the improvement brought about in the soil conditions. Charcoal rectifies the stiffness of clay soils and affords better drainage facilities. The aeration factor also is very largely modified on account of the porosity of the charcoal and its capacity to occlude large amounts of gases. Owing to the establishment of better sanitary conditions within the soil, healthier and more vigorous root growth ensues, resulting ultimately in an improvement of the whole plant system.

It is a hopeful sign that experienced horticulturists like Mr. Set are now taking up practical investigations on the subject of plant growth. [J. S.]

Correspondence

MANURING OF ORANGE PLANTS.

TO THE EDITOR,

The Agricultural Journal of India.

SIR,

IN Vol. XV, Part V (Sept. 1920), of the *Agricultural Journal of India*, pp. 511-513, Mr. K. P. Shrivastava, Offg. Economic Botanist, Central Provinces, describes a manurial experiment on orange trees.

It would greatly interest me and other readers if the author would give the following additional information :

(1) At what distance apart were the trees and lines of trees in the experiment ?

(2) Did each line get a separate manurial treatment ?

(3) What precautions were taken to ensure that the trees of one line were not being fed partly or wholly by the manure given to the adjacent line ?

COLLEGE OF AGRICULTURE, POONA :
Sept. 20, 1920.

Yours faithfully,

W. BURNS,
*Economic Botanist to the
Govt. of Bombay.*

NEW BOOKS

ON AGRICULTURE AND ALLIED SUBJECTS

1. General Botany for Universities and Colleges, by Prof. H. D. Densmore. Pp. xii + 459. (Boston and London : Ginn & Co.) Price, 12s. 6d. net.
2. Types and Breeds of Farm Animals, by Prof. C. S. Plumb. Revised Edition. Pp. viii+820. (Boston and London : Ginn & Co.) Price, 16s. 6d. net.
3. Butter and Cheese, by C. W. Walker Tisdale and Jean Jones. (Pitman's Common Commodities and Industries.) Pp. ix+142. (London : Sir Isasc Pitman and Sons, Ltd., n.d.) Price, 2s. 6d. net.
4. The Sugar-Beet in America, by Prof. F. S. Harris. Pp. xviii+342+xxxii plates. (New York : The Macmillan Co. ; London : Macmillan and Co., Ltd.) Price, 12s. net.
5. Cytology with Special Reference to the Matazoan Nucleus, by W. E. Agar. Pp. xii+224. (London : Macmillan & Co., Ltd.).
6. Industrial Alcohol, by Robert N. Tweedy. (Co-operative Reference Library, Dublin.) Price, 1s. net.
7. Forage Crops in Denmark. The Feeding Value of Roots, selected Strains of Roots and Grasses, Guarantees in the Trade of Seeds. Pp. 100. (London : Longmans Green.) Price, 6s. net.
8. Stories for the Nature Hour, compiled by Ada M. Skinner and Eleanor L. Skinner. Pp. 253. (London : George G. Harrap & Co.) Price, 5s. net.
9. A Manual of Elementary Zoology, by L. A. Borradaile. Third Edition. Pp. xviii+616+xxi plates. (London : Henry Frowde and Hodder and Stoughton.) Price, 18s.

10. Wild Creatures of Garden and Hedgerow, by Frances Pitt. Pp. ix+285. (London: Constable & Co.) Price, 12s. net.
11. A Handbook of Physics and Chemistry, by H. E. Corbin and A. M. Stewart. Fifth Edition. Pp. viii+496. (London: J. and A. Churchill.) Price, 15s. net.
12. Pyrometry, by Chas. R. Darling, F.I.C. Second Edition. (E. & F. N. Spin, Ltd., 57, Haymarket, London, S. W. 1.) Price, 10s. 6d. net.
13. The Manufacture of Alcohol from Molasses and Cane Juice, by J. Magne, Chemical Engineer, 36, Morgan Boulverad, New Orleans, La., U.S.A.
14. Grasses and Rushes and How to Identify them, by J. H. Crabtree. Pp. 64. (London: The Epworth Press, n.d.) Price, 1s. 9d. net.

The following publications have been issued by the Imperial Department of Agriculture since our last issue:—

Memoirs.

1. Some Aspects of the Indigo Industry in Bihar. Part I.—The Wilt Disease of Indigo. Part II.—The factors underlying the Seed Production and Growth of Java Indigo, by Albert Howard, C.I.E., M.A., and Gabrielle L. C. Howard, M.A., with the assistance of Chowdhury Ram Dhan Singh and Maulvi Abdur Rahman Khan. (Botanical Series, Vol. XI, No. 1.) Price, R. 1-2 or 2s.
2. New Indian Gall Midges (Diptera), by E. P. Felt, and Description of a Rhinocyphine Larva from Shillong, by Major F. C. Fraser, I.M.S. (Entomological Series, Vol. VII, Nos. 1 and 2.) Price, As. 12 or 1s. 6d.

**LIST OF AGRICULTURAL PUBLICATIONS IN
INDIA FROM THE 1ST FEBRUARY
TO THE 31ST JULY, 1920.**

No.	Title	Author	Where published
GENERAL AGRICULTURE			
1	<i>The Agricultural Journal of India</i> , Vol. XV, Parts II, III & IV. Price R. 1-8 or 2s. per part : annual subscription Rs. 6 or 9s. 6d.	Edited by the Agricultural Adviser to the Government of India.	Messrs. Thacker, Spink & Co., Calcutta.
2	The Orange : A Trial of Stocks at Peshawar. Pusa Agricultural Research Institute Bulletin No. 93. Price As. 6.	W. Robertson Brown, Agricultural Officer, North-West Frontier Province.	Government Printing India, Calcutta.
3	Motor Tractors at Lincoln Trials (free).	Issued from the Agricultural Research Institute, Pusa.	Ditto.
4	Agricultural Statistics of India, 1917-18. Vol. 1. Price Rs. 2.	Issued by the Department of Statistics, India.	Ditto.
5	Agricultural Statistics of British India, 1918-19. Price As. 4.	Ditto. ..	Ditto.
6	Report on the Production of Tea in India in the Calendar Year 1919. Price As. 8.	Ditto. ..	Ditto.
7	Estimates of Area and Yield of Principal Crops in India, 1918-19. Price As. 8.	Ditto. ..	Ditto.
8	Palm <i>gul</i> manufacture in the Bombay Presidency. Bombay Department of Agriculture Bulletin No. 93. Price R. 1-3-9.	V. G. Gokhale, L. Ag., Deputy Director of Agriculture, Konkan.	Verayda Prison Press, Poona.
9	Season and Crop Report of the Bombay Presidency for the year 1918-19.	Issued by the Department of Agriculture, Bombay.	Government Central Press, Bombay
10	Cambodia Cotton. Madras Department of Agriculture Leaflet No. 4 of 1920.	S. C. Sampson, B. sc., Deputy Director of Agriculture, V & VII Circles, Madras.	Government Press, Madras.

LIST OF AGRICULTURAL PUBLICATIONS—*contd.*

No.	Title	Author	Where published
<i>General Agriculture—contd.</i>			
11	Cultivation of Cambodia Cotton in Ceded Districts. Madras Department of Agriculture Leaflet No. 5 of 1920.	S. Ramasami Pillai, Assistant Director of Agriculture, II & III Circles, Madras.	Government Press, Madras.
12	Note on Sugarcane Cultivation for the use of the ryots in North Arcot, South Arcot and Chittore Districts. Madras Department of Agriculture Leaflet No. 6 of 1920.	J. Chelvaranga Raju Garu, Deputy Director of Agriculture, IV Circle, Madras.	Ditto.
13	Note on Tapioca Cultivation. Madras Department of Agriculture Leaflet No. 7 of 1920.	M. Govinda Kidavu, Assistant Director of Agriculture, VII Circle, Madras.	Ditto.
14	How to increase production of Crops. Madras Department of Agriculture Leaflet No. 9 of 1920.	D. Balkrishna Murthi Garu, Acting Deputy Director of Agriculture, I Circle, Madras.	Ditto.
15	Season and Crop Report of Bengal for the year 1919-20. Price R. 1-6.	Issued by the Department of Agriculture, Bengal.	The Bengal Secretariat Book Depôt, Calcutta.
16	Agricultural Statistics of Bengal for 1918-19. Price R. 1-5 or 2s. 8d.	Issued by the Revenue Department of the Government of Bengal.	Ditto.
17	Season and Crop Report of Bihar and Orissa for 1919-1920. Price R. 1-2-0.	Issued by the Department of Agriculture, Bihar and Orissa.	Bihar and Orissa Government Press, Patna.
18	Agricultural Statistics of Bihar and Orissa for 1918-19. Price As. 14.	Ditto.	Ditto.
19	Agricultural Calendar for 1920-21 (in Burmese).	Issued by the Department of Agriculture, Burma.	Government Printing, Burma, Rangoon.
20	Cultivation of Potatoes, Burma Cultivator's Leaflet No. 53. (in Romanised Kachin).	F. Clerk, Assistant Superintendent, Htaw-gaw.	Ditto.
21	Seed Storage. Burma Cultivator's Leaflet No. 54.	E. Thompstone, B. sc., Deputy Director of Agriculture, Northern Circle, Burma.	Ditto.
22	Cultivation of "Pesingon" (<i>Cajanus indicus</i>). Burma Cultivator's Leaflet No. 55.	Ditto.	Ditto.

LIST OF AGRICULTURAL PUBLICATIONS

LIST OF AGRICULTURAL PUBLICATIONS—contd.

No.	Title	Author	Where published
<i>General Agriculture—contd.</i>			
23	(a) Minutes of a Conference of Officers of the Irrigation, Co-operative and Agricultural Departments held at Maymyo on the 16th April, 1920.	Issued by the Department of Agriculture, Burma.	Government Printing, Burma, Rangoon.
	(b) Sub-committee's Report on Water Measuring Experiments.		
24	Minutes of an Agricultural Conference held at Maymyo on the 17th April, 1920.	Ditto.	Ditto.
25	Minutes of an Agricultural Conference held at Maymyo on the 19th April, 1920.	Ditto.	Ditto.
26	<i>The Agricultural and Co-operative Gazette</i> (Monthly) from February to July 1920. Price As. 2 per copy.	Issued by the Department of Agriculture, Central Provinces.	Sholam Press, Nagpur.
27	Report of the Department of Agriculture, Assam, for the year ending 31st March, 1920.	Issued by the Department of Agriculture, Assam.	Assam Secretariat Printing Office, Shillong.
28	Tables of Agricultural Statistics of Assam for the year 1918-19.	Ditto.	Ditto.
29	Report of the Upper Shillong Agricultural Experiment Station for the year ending 31st March, 1920.	Ditto.	Ditto.
30	Report of the Kamrup Sugarcane Experiment Station for the year ending 31st March, 1920.	Ditto.	Ditto.
31	Report of the Fruit Experiment Station, Shillong, for the year ending 31st March, 1920.	Ditto.	Ditto.
32	Report of the Karimganj Agricultural Experiment Station for the year ending the 31st March, 1920.	Ditto.	Ditto.
33	Report of the Jorhat Agricultural Experiment Station for the year ending 31st March, 1920.	Ditto.	Ditto.
34	Cultivation of <i>dals</i> or pulses in the Assam Valley. Assam Department of Agriculture Leaflet No. 1 of 1920.	Ditto.	Ditto.

LIST OF AGRICULTURAL PUBLICATIONS—*contd.*

No.	Title	Author	Where published
<i>General Agriculture—concl'd.</i>			
35	Cultivation of <i>dals</i> or pulses in the Surma Valley. Assam Department of Agriculture Leaflet No. 2 of 1920.	Issued by the Department of Agriculture, Assam.	Assam Secretariat Printing Office, Shillong.
36	Season and Crop Report of Assam for the year ending the 31st March, 1920. Price As. 8.	Ditto.	Ditto.
37	<i>The Journal of the Madras Agricultural Students' Union</i> (Monthly). Annual subscription Rs. 2.	Madras Agricultural Students' Union.	Literary Sun Press, Coimbatore.
38	<i>Quarterly Journal of the Indian Tea Association</i> . Price As. 6 per copy.	Scientific Department of the Indian Tea Association, Calcutta.	Catholic Orphan Press, Calcutta.
39	<i>The Journal of Dairying and Dairy Farming in India</i> (Quarterly). Subscription Rs. 5 per annum including membership.	Published by the Indian Committee of the Dairy Education Association, Quetta.	Messrs. Thacker, Spink & Co., Calcutta.
40	<i>Journal of the Mysore Agricultural and Experimental Union</i> (Quarterly). Annual subscription Rs. 3.	Mysore Agricultural Experimental Union.	Bangalore Press, Bangalore.
41	<i>Poona Agricultural College Magazine</i> (Quarterly). Annual subscription Rs. 2.	College Magazine Committee, Poona.	Arya Bhushan Press, Poona.
BOTANY			
42	The Cultivation of Oranges and allied Fruits in the Bombay Presidency. Bombay Department of Agriculture Bulletin No. 95. Price As. 2½.	H. P. Paranjpe, B.A., Assistant Economic Botanist, Poona.	Yeravda Prison Press, Poona.
MYCOLOGY			
43	Budrot of Palmyra and Coconut Palms in Godavari and Kistna Districts. Madras Department of Agriculture Leaflet No. 8 of 1920.	Bhogappaya Sastri.	Government Press, Madras.
ENTOMOLOGY			
44	The Rice Leaf Hoppers (<i>Nephotettix bipunctatus</i> , Fabr. and <i>Nephotettix apicalis</i> , Motsch.). Memoirs of the Department of Agriculture in India, Entomological Series, Vol. V, No. 5. Price R. 1-8-0 or 3s.	C. S. Misra, B.A., First Assistant to the Imperial Entomologist, Pusa.	Messrs. Thacker, Spink & Co., Calcutta.

LIST OF AGRICULTURAL PUBLICATIONS

LIST OF AGRICULTURAL PUBLICATIONS—*contd.*

No.	Title	Author	Where published
<i>Entomology—concl'd.</i>			
45	<i>Lantana</i> Insects in India. Being the Report of an Inquiry into the efficiency of indigenous Insect Pests as a check on the spread of <i>Lantana</i> in India. Memoirs of the Department of Agriculture in India, Entomological Series, Vol. V, No. 6. Price Rs. 2-4 or 4s. 6d.	Rao Sahib Y. Ramachandra Rao, M.A., F.E.S., Entomological Assistant, Madras.	Messrs. Thacker, Spink & Co., Calcutta.
46	(a) New Indian Midges (<i>Diptera</i>). Memoirs of the Department of Agriculture in India, Entomological Series, Vol. VII, No. 1.	E. P. Felt, State Entomologist of New York, U. S. A.	Ditto.
	(b) Description of a Rhinocyphine larva from Shillong. Memoirs of the Department of Agriculture in India, Entomological Series, Vol. VII, No. 2. Price As. 12 or 1s. 6d. (for both numbers bound together).	Major F. C. Fraser, I.M.S.	Ditto.
47	The Sugarcane Borer and its Control. Bombay Department of Agriculture Bulletin No. 94. Price As. 4-3.	Ramrao S. Kasargode, L. Ag., Assistant Professor of Entomology, Agricultural College, Poona.	Veravda Prison Press, Poona.
BACTERIOLOGY			
48	Studies on the Root Nodule Organism of the Leguminous Plants. Memoirs of the Department of Agriculture in India, Bacteriological Series, Vol. I, No. 9. Price R. 1-4 or 2s. 6d.	N. V. Joshi, B.A., M.Sc., L.Ag., 1st Assistant to the Imperial Agricultural Bacteriologist.	Messrs. Thacker, Spink & Co., Calcutta.
VETERINARY			
49	<i>Syngamus laryngus</i> in Cattle and Buffaloes in India. Pusa Agricultural Research Institute Bulletin No. 92. Price As. 6.	A. L. Sheather, B.Sc., M.R.C.V.S., Director and 1st Bacteriologist, Imperial Bacteriological Laboratory, Muktesar, and A. W. Shilston, M.R.C.V.S., Second Bacteriologist, Imperial Bacteriological Laboratory, Muktesar.	Government Printing India, Calcutta.

LIST OF AGRICULTURAL PUBLICATIONS—*concl'd.*

No.	Title	Author	Where published
<i>Veterinary—concl'd.</i>			
50	A Note on the Treatment of Surra in Camels by Intravenous Injections of Tartar Emetic. Pusa Agricultural Research Institute Bulletin No. 95. Price As. 2.	H. E. Cross, M.R.C.V.S., D.V.H., A.Sc. , Camel Specialist, Sohawa, Punjab.	Government Printing India, Calcutta.
51	Annual Administration Report of the Bombay Veterinary College and Civil Veterinary Department in the Bombay Presidency (including Sind) 1918-19. Price As. 6 or 9d.	Issued by the Bombay Government in the General Department.	Government Central Press, Bombay.
52	Annual Report of the Civil Veterinary Department, Bihar and Orissa, for 1919-20.	Issued by the Department of Agriculture, Bihar and Orissa.	Government Press, Bihar and Orissa, Patna.
53	Annual Report of the Camel Specialist for the years 1917-18 and 1918-19 (in one volume). Price As. 2.	Issued by the Department of Agriculture, Punjab.	Government Printing Punjab, Lahore.
54	Report of the Civil Veterinary Department, Assam, for the year 1919-20. Price As. 8 or 1s.	Issued by the Department of Agriculture, Assam.	Assam Secretariat Printing Office, Shillong.
55	Statistics compiled by the Government of India from the Report of the Provincial Veterinary Departments for the year 1918-19.	Issued by the Government of India in the Revenue and Agriculture Department.	Government Monotype Press, Simla.

PUBLICATIONS OF THE IMPERIAL DEPARTMENT OF AGRICULTURE IN INDIA

TO BE HAD FROM

THE OFFICE OF THE AGRICULTURAL ADVISER TO THE GOVERNMENT OF INDIA, PUSA, BIHAR,
and from the following Agents :—

- | | |
|--|--|
| (1) THACKER, SPINK & CO., CALCUTTA. | (7) THACKER & CO., LTD., BOMBAY. |
| (2) W. NEWMAN & CO., CALCUTTA. | (8) SUNDER PANDURANG, BOMBAY. |
| (3) RAI M. C. SARKAR BAHADUR & SONS, CALCUTTA. | (9) RAI SAHIB M. GULAB SINGH & SONS, LAHORE. |
| (4) HIGGINBOTHAMS, LTD., MADRAS. | (10) MANAGER, EDUCATIONAL BOOK DEPÔT, NAAGPUR. |
| (5) THOMPSON & CO., MADRAS. | |
| (6) D. B. TARAPOREVALA, SONS & CO., BOMBAY. | |

A complete list of the publications of the Imperial Department of Agriculture in India can be obtained on application from the Agricultural Adviser to the Government of India, Pusa, Bihar, or from any of the above-mentioned Agents.

These publications are :—

1. *The Agricultural Journal of India*. A Journal dealing with subjects connected with agricultural economics, field and garden crops, economic plants and fruits, soils, manures, methods of cultivation, irrigation, climatic conditions, insect pests, fungus diseases, co-operative credit, agricultural cattle, farm implements, and other agricultural matters in India. Illustrations, including coloured plates, form a prominent feature of the Journal. It is edited by the Agricultural Adviser to the Government of India, and is issued once every two months or six times a year. *Annual Subscription*, Rs. 6 or 9s. 6d., including postage. Single copy, R. 1-8 or 2s.
2. Scientific Reports of the Agricultural Research Institute, Pusa (including the Report of the Imperial Cotton Specialist).
3. Annual Report on the Progress of Agriculture in India.
4. Proceedings of the Board of Agriculture in India.
5. Proceedings of Sectional Meetings of the Board of Agriculture.
6. Memoirs of the Imperial Department of Agriculture in India :
 - (a) Botanical Series.
 - (b) Chemical Series.
 - (c) Entomological Series.
 - (d) Bacteriological Series.
 - (e) Veterinary Series.
7. Bulletins issued by the Agricultural Research Institute, Pusa.
8. Books.

The following are the publications of the last two years :—

- Scientific Reports of the Agricultural Research Institute and College, Pusa (including the Report of the Imperial Cotton Specialist), for the year 1917-18. Price, R. 1-4 or 2s.
- Scientific Reports of the Agricultural Research Institute, Pusa (including the Report of the Imperial Cotton Specialist), for the year 1918-19. Price, R. 1-4 or 2s.
- Report on the Progress of Agriculture in India for the year 1917-18. Price, R. 1-8 or 2s. 3d.
- Report on the Progress of Agriculture in India for the year 1918-19. Price, R. 1-8 or 2s. 3d.
- Proceedings of the Board of Agriculture in India, held at Pusa on the 1st December, 1919, and following days (with Appendices). Price, As. 12 or 1s. 3d.
- Proceedings of the Second Meeting of Mycological Workers in India, held at Pusa on the 20th February, 1919, and following days. Price, As. 11 or 1s.
- Proceedings of the First Meeting of Agricultural Chemists and Bacteriologists, held at Pt. a on 24th February, 1919, and the following days. Price, R. 1 or 1s. 6d.

AGRICULTURAL PUBLICATIONS—(Continued.)

Proceedings of the First Meeting of Veterinary Officers in India, held at Lahore on 24th March, 1919, and following days (with Appendices). Price, As. 8 or 9d.

Proceedings of the Third Entomological Meeting, held at Pusa in February 1919. (*In press.*)

MEMOIRS OF THE DEPARTMENT OF AGRICULTURE IN INDIA

BOTANICAL SERIES

- Vol. X, No. I. The Rice Worm (*Tylenchus angustus*) and its Control, by E. J. BUTLER, M.B., F.L.S. Price, R. 1-4 or 2s.
- Vol. X, No. II. Studies in Indian Sugarcanes, No. 4. Tillering or Underground Branching, by C. A. BARBER, C.I.E., sc.D., F.L.S. Price, R. 4-4 or 7s.
- Vol. X, No. III. Studies in Indian Sugarcanes, No. 5. On testing the suitability of sugarcane varieties for different localities, by a system of measurements. Periodicity in the growth of the sugarcane, by C. A. BARBER, C.I.E., sc.D., F.L.S. Price, R. 1-12 or 3s.
- Vol. X, No. IV. A *Pythium* Disease of Ginger, Tobacco and Papaya, by L. S. SUBRAMANIAM. Price, R. 1-8 or 2s. 6d.
- Vol. X, No. V. Studies in the Pollination of Indian Crops, 1, by A. HOWARD, GABRIELLE L. C. HOWARD, and ABDUR RAHMAN KHAN. Price, R. 1-4 or 2s. 6d.
- Vol. X, No. VI. "Kumpta" Cotton and its Improvement, by G. L. KOTTUR, B. Ag. Price, R. 1-12 or 3s.
- Vol. XI, No. I. Some Aspects of the Indigo Industry in Bihar. Part I. The Wilt Disease of Indigo. Part II. The factors underlying the seed production and growth of Java Indigo, by ALBERT HOWARD, C.I.E., M.A., and GABRIELLE L. C. HOWARD, M.A., with the assistance of CHOWDHARY RAMDHAN SINGH and MAULVI ABDUR RAHMAN KHAN. Price, R. 1-2 or 2s.
- Vol. XI, No. II. Studies in Diseases of the Jute Plant. (1) *Diplodia Corchori*, Syd., by F. J. F. SHAW, D.Sc., A.R.C.S., F.L.S. (*In the press.*)

CHEMICAL SERIES

- Vol. V, No. IV. Cholam (*A. Sorghum*) as a Substitute for Barley in Malting Operations, by B. VISWANATH, T. LAKSHMANA ROW, B.A., and P. A. RAGHUNATHASWAMI AYYANGAR. Dip. ag. Price, As. 12 or 1s.
- Vol. V, No. V. The Phosphate Requirements of some Lower Burma Paddy Soils, by F. J. WARTH, M.Sc., B.Sc., and MAUNG PO SHIN. Price, R. 1-12 or 3s. 3d.
- Vol. V, No. VI. Absorption of Lime by Soils, by F. J. WARTH, M.Sc., B.Sc., and MAUNG PO SAW. Price, R. 1-2 or 2s.
- Vol. V, Nos. VII & VIII. The Gases of Swamp Rice Soils, V—A Methane-oxidizing Bacterium from Rice Soils, by P. A. SUBRAHMANYA AYYAR, B.A.; and The Gases of Swamp Rice Soils, VI—Carbon Dioxide and Hydrogen in relation to Rice Soils, by W. H. HARRISON, D.Sc. (*In the press.*)
- Vol. V, No. IX. The Retention of Soluble Phosphates in Calcareous and Non-calcareous Soils, by W. H. HARRISON, D.Sc., and SURENDRA LAL DAS, M.Sc. (*In the press.*)

ENTOMOLOGICAL SERIES

- Vol. V, No. V. The Rice Leaf-hoppers (*Nephotettix bipunctatus*, Fabr. and *Nephotettix apicalis*, Motsch.), by C. S. MISRA, B.A. Price, R. 1-7 or 3s.
- Vol. V, No. VI. *Lantana* Insects in India. Being the Report of an Inquiry into the Efficiency of Indigenous Insect Pests as a Check on the Spread of *Lantana* in India, by RAO SAHIB Y. RAMACHANDRA RAO, M.A., F.R.S. Price, R. 2-4 or 4s. 6d.
- Vol. VI, Nos. I—IX. Life-histories of Indian Insects: Microlepidoptera, by T. BAINBRIGGE FLETCHER, B.N., F.L.S., F.R.S., F.Z.S. (*In the press.*)
- Vol. VII, Nos. 1 & 2. New Indian Gall Midges (Diptera), by E. P. FELT, and Description of a Rhinocyphine larva from Shillong, by MAJOR F. O. FRASER, I.M.S. Price, As. 12 or 1s. 6d.

BACTERIOLOGICAL SERIES

- Vol. I, No. VIII. Pebrine in India, by C. M. HUTCHINSON, B.A. (*In the press.*)
Vol. I, No. IX. Studies on the Root Nodule Organism of the Leguminous Plants, by N. V. JOSHI, M.Sc., B.A., L.Ag. Price, R. 1-4 or 2s. 6d.

VETERINARY SERIES

- Vol. III, No. I. The Vitality of the Rinderpest Virus outside the Animal Body under Natural Conditions, by A. W. SHILSTON, M.R.C.V.S. Price, As. 12 or 1s.
Vol. III, No. II. The Virulence of Tubercle Bacilli isolated from Bovine Lesions in India, by A. L. SHEATHER, B.Sc., M.R.C.V.S. (*In the press.*)
Vol. III, No. III. Bovine Lymphangitis, by A. L. SHEATHER, B.Sc., M.R.C.V.S. (*In the press.*)

BULLETINS ISSUED BY THE AGRICULTURAL RESEARCH INSTITUTE, PUSA

- No. 83. Progress of the Sugarcane Industry in India during the Years 1916 and 1917. Being Notes submitted to the Meeting of the Board of Agriculture in India, Poona, 1917. Edited, with an Introduction, by C. A. BARBER, C.I.E., Sc.D., F.L.S. Price, As. 5 or 6d.
No. 84. The Best Means of Rapidly Increasing the Outturns of Food Crops by Methods within the Power of the Agricultural Department. Being Notes submitted to the Meeting of the Board of Agriculture in India, Poona, 1917. Edited, with an Introduction, by J. MACKENNA, C.I.E., I.C.S. Price, As. 4 or 5d.
No. 85. Soil Drainage. by R. G. ALLAN, M.A. Price, As. 4 or 5d.
No. 86. A New Nematode causing Parasitic Gastritis in Calves, by A. L. SHEATHER, B.Sc., M.R.C.V.S. Price, As. 4 or 5d.
No. 87. A Contribution to our Knowledge of South Indian Coccidæ, by T. V. RAMAKRISHNA AYYAR, B.A., F.E.S., F.Z.S. Price, As. 14 or 1s. 6d.
No. 88. Cawnpore-American Cotton: An Account of Experiments in its Improvement by Pure Line Selection and of Field Trials, 1913-1917, by B. C. BURT, B.Sc., and NIZAMUDDIN HAIDER. Price, As. 10 or 1s.
No. 89. Second Hundred Notes on Indian Insects. Price, R. 1-4 or 2s.
No. 90. A Malarial Parasite in the Blood of a Buffalo, by A. L. SHEATHER, B.Sc., M.R.C.V.S. Price, As. 6 or 7d.
No. 91. Notes on Practical Salt Land Reclamation, by G. S. HENDERSON, N.D.A., N.D.D. Price, As. 6.
No. 92. Syngamus laryngus in Cattle and Buffaloes in India, by A. LESLIE SHEATHER, B.Sc., M.R.C.V.S., and A. W. SHILSTON, M.R.C.V.S. Price, As. 6.
No. 93. The Orange: A Trial of Stocks at Peshawar, by W. ROBERTSON BROWN. Price, As. 6.
No. 94. A Preliminary Note on the Behaviour in North India of the first batch of Sugarcane Seedlings distributed from the Sugarcane-breeding Station, Coimbatore, by T. S. VENKATRAMAN, B.A. Price, As. 8.
No. 95. A Note on the Treatment of Surra in Camels by Intravenous Injections of Tartar Emetic, by H. E. CROSS, M.R.C.V.S., D.V.H., A.Sc. Price, As. 2.
No. 96. A Summary of Experiments on Rice in Bihar and Orissa from 1912 to 1919, by G. C. Sherrard, B.A. (*In the press.*)
No. 97. *Utilago Cramerii*, Koern. on *Setaria italica*, by S. SUNDERARAMAN, M.A. (*In the press.*)
No. 98. The Course that Surra runs in Camels when Naturally Contracted and when Artificially Inoculated, by H. E. CROSS, M.R.C.V.S., D.V.H., A.Sc. (*In the press.*)
No. 99. The Course that Camel Surra runs in Ponies, Buffaloes and other Animals, by H. E. CROSS, M.R.C.V.S., D.V.H., A.Sc. (*In the press.*)

INDIGO PUBLICATIONS

- No. 1. A Study of the Indigo Soils of Bihar. The Urgent Necessity for Immediate Phosphate Manuring if Crops are to be Maintained, by W. A. DAVIS, B.Sc., A.C.G.I. Price, R. 1-4 or 2s.

INDIGO PUBLICATIONS (*Conold.*)

- No. 2. **Present Position and Future Prospects of the Natural Indigo Industry**, by W. A. DAVIS, B.Sc., A.C.G.I. Price, As. 10 or 1s.
- No. 3. **The Loss of Indigo caused by Bad Settling and the means of obviating this. The use of Dhak Gum—its Effect on Yield and Quality**, by W. A. DAVIS, B.Sc., A.C.G.I. Price, As. 4 or 5d.
- No. 4. **The Future Prospects of the Natural Indigo Industry: The Effect of Superphosphate Manuring on the Yield and Quality of the Indigo Plant**, by W. A. DAVIS, B.Sc., A.C.G.I. Price, As. 4 or 5d.
- No. 5. **An Improved Method of preparing Indican from Indigo-yielding Plants**, by BHAILAL M. AMIN, B.A. Price, As. 2 or 3d.
- No. 6. **The Effect of Manuring with Superphosphate and Sannal on the Yield of Crops on Indigo Planters' Estates in Bihar—especially of Rabi Crops in the Season 1918-1919**, by W. A. DAVIS, B.Sc., A.C.G.I. Price, As. 6.
- No. 7. **The Conditions affecting the Quality of the Java Indigo Plant (Leaf yield and richness of the leaf in indigotin)**, by W. A. DAVIS, B.Sc., A.C.G.I. (*In the press.*)

BOOKS

- "**Indian Insect Pests**," by H. MAXWELL-LEFROY, M.A., F.E.S., F.Z.S. Price, R. 1-8 or 2s. (*Out of print.*)
- "**Indian Insect Life**," by H. MAXWELL-LEFROY, M.A., F.E.S., F.Z.S.; and F. M. HOWLETT, B.A. 786 pp. Price, R. 20 or 30s. (*Out of print.*)
- "**Wheat in India**," by ALBERT HOWARD, M.A., A.R.C.S., F.L.S.; and GABRIELLE L. C. HOWARD, M.A. 288 pp. Price, R. 5 or 7s. 6d.
- "**A Description of the Imperial Bacteriological Laboratory, Muktesar: Its Work and Products**," by Major J. D. R. HOLMES, M.A., D.Sc., M.R.C.V.S. Price, As. 8 or 9d.
- "**Agriculture in India**," by JAMES MACKENNA, M.A., I.C.S. Price, As. 4 or 5d.
- "**Some Diseases of Cattle in India. A Handbook for Stock-owners**," Price, As. 8 or 9d.
- "**The Importance of Bacterial Action in Indigo Manufacture**," by C. M. HUTCHINSON, B.A. Price, As. 2 or 3d.
- "**Report of the Proceedings of the Second Entomological Meeting, held at Pusa on the 5th-12th February, 1917.**" Price, R. 3.

Report of the Indian Cotton Committee. Vol. I, Report; Vol. II, Maps and Plans. Price, R. 1 per volume. (Superintendent, Government Printing India, Calcutta.)

Minutes and evidence taken before the Indian Cotton Committee:—

- Vol. I. **Agriculture, Part I (United Provinces, Central Provinces, Burma, North-West Frontier Province, Punjab and Sind).** Price, Rs. 2 As. 6.
- Vol. II. **Agriculture, Part II (Bombay, Madras, Bengal, Bihar and Orissa, Imperial Officers, Central India, Baroda, Hyderabad and Mysore).** Price, Rs. 2 As. 13.
- Vol. III. **Irrigation (United Provinces, Central Provinces, North-West Frontier Province, Bengal and Sind).** Price, R. 1 As. 12.
- Vol. IV. **Commercial, Part I (United Provinces, Central Provinces, Burma, Punjab, Sind and Bombay).** Price, Rs. 2 As. 2.
- Vol. V. **Commercial, Part II (Madras, Bengal, Imperial Officers, Central India, Baroda and Hyderabad).** Price, R. 1 As. 12.

